

CIRCULATION LARGER THAN THAT OF ANY OTHER RADIO PUBLICATION

RADIO NEWS

REG. U. S. PAT. OFF.

SEPTEMBER
25 Cents

Over 200
Illustrations



Edited by HUGO GERNSBACK

A "BUM"
RADIO

See Page 236



RADIO'S GREATEST MAGAZINE

EXPERIMENTER PUBLISHING COMPANY, NEW YORK, PUBLISHERS OF

SCIENCE and INVENTION RADIO REVIEW AMAZING STORIES RADIO INTERNACIONAL



The new Tower cone

—majestically sweet \$9.50

LIKE the grand cathedral organ—mighty monarch of all musical instruments—the new Tower Cone runs the entire gamut of tone, bringing to you each note, majestically sweet and clear—with the variety of color and shading demanded by the real musical critic.

Due to the exclusive direct-drive unit with its eight points of contact from unit to cone, the new Tower Cone gives not only a complete range of tone, but a beauty of “voicing”, and a responsiveness to changes of tempo, long sought but never until now achieved.

Your Dealer Will Be Glad to Demonstrate

TOWER MFG. CORP. ~ BOSTON MASS.

RADIO NEWS

Published by EXPERIMENTER PUBLISHING COMPANY, Inc., Publishers of "Radio News," "Science and Invention," "Radio Internacional," "Radio Review" and "Amazing Stories."

Editorial and General Offices: 53 Park Pl., New York City

H. GERNSBACK, President.

S. GERNSBACK, Treasurer.

R. W. DEMOTT, Secretary

Member: Audit Bureau of Circulations

Radio Magazine Publishers Association

VOLUME 8

SEPTEMBER, 1926

NUMBER 3

Contents of This Issue:

Is Radio at a Standstill? By Hugo Gernsback	203	The Eusonic Receiver, By Joseph Bernsley	228
How to Make Radio Pay Your Way, By C. William Rados	204	How to Build Wireless Receivers, By Edmund T. Flewelling	231
Television an Accomplished Fact, By A. Dinsdale	206	A Family Receiver, By Watson Brown	232
Radio News of the Month Illustrated, By George Wall	208	A New Idea in Set Construction, By Joseph Riley	234
What Price Salesmanship? By N. B. Platt	209	The Hobodyne, By "Bo" McHinnsey	236
Radio Equipment of the Byrd Polar Flight	210	The Detectorium, By Hugo Gernsback	237
Radio—Here, There and Everywhere,	211	A Tuned-Radio-Frequency Regenerative Receiver, By Roy Lyster	238
WRNY Celebrates Its First Birthday, By Charles D. Isaacson	212	Tubes Within Tubes, A Combined "B" Eliminator and Power Amplifier, By D. E. Harnett	240
"Echoing Silence," By George B. Ludlum	213	Alleviation of Static, By L. W. Hatry	242
Audio Amplification for the Beginner, By A. P. Peck	214	Overloading the Audio Amplifier, By Sylvan Harris	244
Radio Set Owners' Information,	216	A Plug-In Coil Short-Wave Receiver, By A. P. Peck	245
List of Broadcast Stations in the United States,	217	Radio Wrinkles—Awards in \$50.00 Prize Contest,	246
The Latest Discoveries in the Range of Electromagnetic Wave-lengths. By Prof. Boris Weinberg	218	Radiotics,	248
New Developments in Radio Apparatus. By G. C. B. Rowe	220	Standard Hook-Ups, With the Amateurs—Constructing a Ripple Meter, By Edward W. Berry	251
An Ultra-Modern Radio Factory, By B. H. Baker	222	RADIO NEWS LABORATORIES,	252
Radio-Operated Furnace Melts Precious Metals, By S. R. Winters	223	I Want to Know, By Joseph Bernsley	254
Kits of Parts for the Set Constructor, By M. L. Muhleman	224	Correspondence from Readers,	256
		Calls Heard,	272, 309
		Q. R. A's.	285
		Book Reviews,	285
		Radio Jingles,	287

In Forthcoming Issues:

ESTABLISHMENT OF RADIO STANDARDS OF FREQUENCY.

An interesting explanation of the manner in which frequencies are measured to a remarkable degree of accuracy, thus standardizing transmission.

AUDIO-FREQUENCY AMPLIFYING DEVICES.

The series of articles by Sylvan Harris, explaining the problems of obtaining better reproduction from receivers, and how they are being met, will continue.

CIRCUITS FAVORED BY BRITISH LISTENERS.

Articles will appear describing and illustrating, with circuit diagrams, the types of sets which are giving most satisfaction on the other side.

RADIO NEWS is published on the 10th of each preceding month. There are 12 numbers per year. Subscription price is \$2.50 a year in U. S. and possessions. Canada and foreign countries, \$3.00 a year. U. S. Coin as well as U. S. Stamps accepted (no foreign coins or stamps). Single copies, 25 cents each. Checks and money orders should be drawn to order of EXPERIMENTER PUBLISHING CO., INC.

All communications and contributions to this journal should be addressed to Editor, RADIO NEWS, 53 Park Place, New York, N. Y. Unaccepted contributions cannot be returned unless full postage has been included. All accepted contributions are paid for on publication. A special rate is paid for novel experiments; good photographs accompanying them are highly desirable.

RADIO NEWS, Monthly. Entered as second class matter, July 12, 1924, at the Post Office at New York, N. Y., under the Act of March 3, 1879. Additional entry at Long Island City, N. Y., and San Francisco, Calif. Title registered U. S. Patent Office. Copyright, 1926, by The Experimenter Publishing Co., Inc., 53 Park Place, New York. The contents of this magazine are copyrighted and must not be reproduced without giving full credit to the publication. Copyrighted in Germany. Reproduction of articles in Germany is reserved for Radio, Berlin 42.

RADIO NEWS is for sale at all newsstands in the United States and Canada.

General Advertising Dept., 53 Park Place, New York City.

Western Advertising Representatives
Finucan & McClure
720 Cass St., Chicago, Ill.

Pacific Coast Advertising Representatives
A. J. Norris Hill Co.
5 Third St., San Francisco, Calif.
412 West 6th St., Los Angeles, Calif.

Kansas City Advertising Representatives
Davies and Dillon
15 W. Tenth St., Kansas City, Mo.

New England Advertising Representative
T. F. Magrane, Park Square Building, Boston, Mass.

Detroit Advertising Representative
Roy Buell, Donovan Bldg., Detroit, Mich.

and at Brentano's, Ave de L'Opera, Paris, France. European agents: S. J. Wise Et Cie, 40 Place Verte, Antwerp, Belgium.

HOW TO SUBSCRIBE FOR RADIO NEWS. Send four name, address and remittance to Experimenter Publishing Co., 53 Park Place, New York. Mention the name of the magazine you are ordering. We also publish SCIENCE AND INVENTION, RADIO INTERNACIONAL, RADIO REVIEW and AMAZING STORIES. Write clearly.

RATES AND TERMS. The subscription rate for RADIO NEWS is \$2.50 per year. (12 numbers). When remitting do so by check, money order, or registered letter if cash is enclosed. Avoid sending cash through the mail if possible. Subscriptions for less than one year are not accepted. Subscription may be made in combination with SCIENCE & INVENTION, RADIO INTERNACIONAL, RADIO REVIEW and AMAZING STORIES.

POSTAGE. We prepay postage in all parts of the United States, Mexico and Island possessions. For foreign or Canadian subscriptions we require 50 cents in addition to the subscription price for additional postage charges.

CHANGE OF ADDRESS. Notify us as far in advance as possible. It requires several weeks to make an address change on our records. Always write clearly. ON EXPIRATION of your subscription we enclose a renewal blank in our last number to you; we stop our delivery to you on expiration.

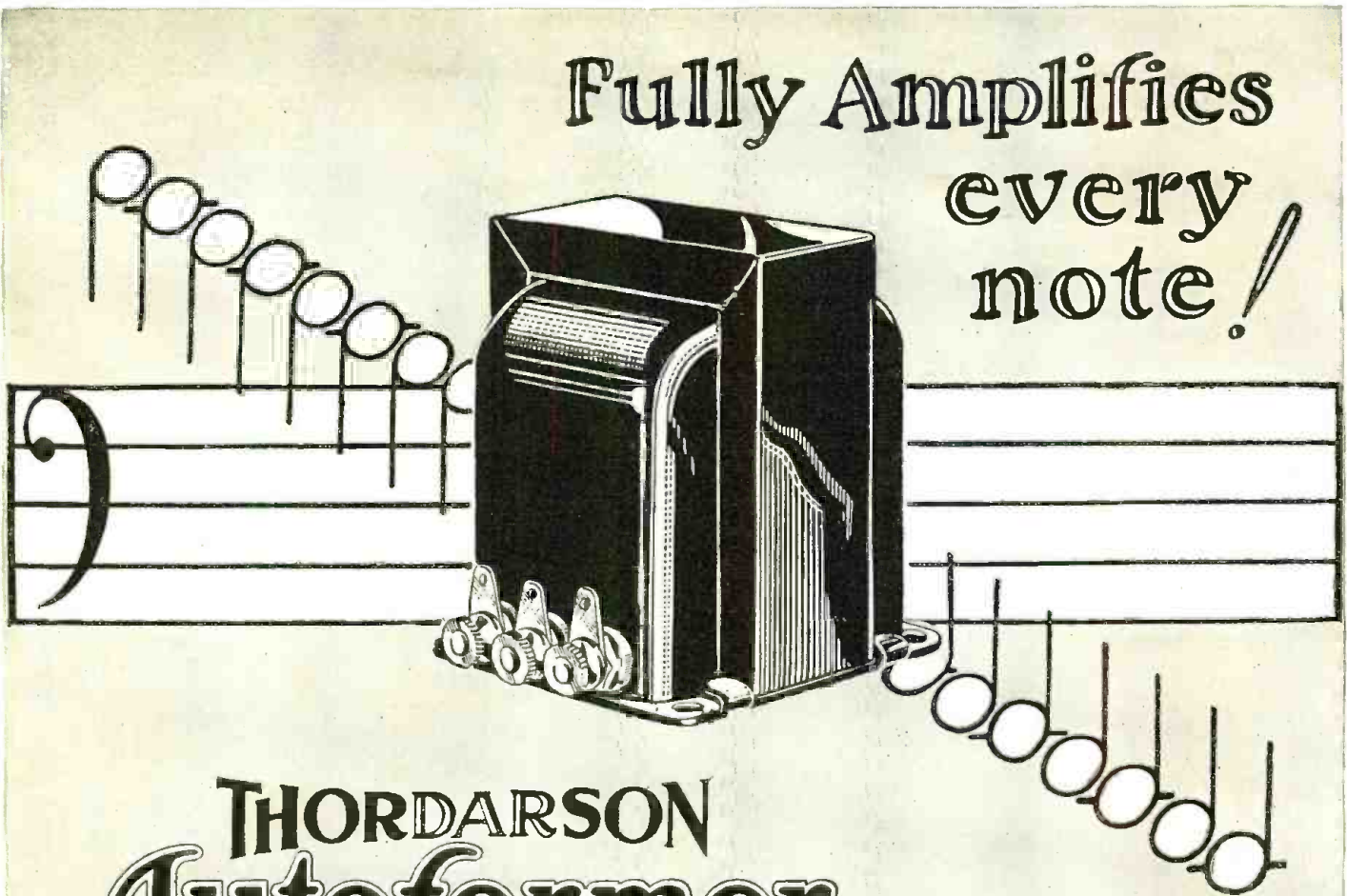

Fully Amplifies
every
note!

THORDARSON Autoformer

Step-up Impedance Coupled Amplifier

Full Amplification
of Bass Notes

Greater Clarity
on all Programs

Improved Reception
of Weaker Stations

Better Volume Control

Impedance coupling is universally accepted as the most perfect form of amplification from a reproductive standpoint—But the amplification increase of the straight impedance is low.

The Thordarson Autoformer is an impedance with a step-up ratio—It combines the faithful reproduction of the impedance with the amplification increase of the transformer, paving the way for the release of the deeper tones with increased volume and unrestrained quality.

Price each \$5.00

Note: Only Thordarson makes the Autoformer

POWER From the A. C. Line

Power Amplifier Supply Transformer, R-198 furnishes current for both plate and filament of the power stage using the U. X. 210 power tube with 400 volts on the plate and 7½ volts on the filament. In addition furnishes complete B-supply for the set.



Price \$12.00

B-Eliminator Transformer R-195 is designed for use with the Raytheon tube, furnishing B voltages for the entire receiver. Capable of supplying 140 volts at 40 milliamperes. Conservatively rated. Will not heat up in continuous service.



Price \$7.00

30 Henry Choke Coif R-196 is used in the filter circuits of power amplifiers and B-eliminators operating from the house lighting current. D. C. resistance 280 ohms. Capacity 70 milliamperes.



Price \$5.00

THORDARSON ELECTRIC MANUFACTURING CO.
Transformer specialists since 1895
WORLD'S OLDEST AND LARGEST EXCLUSIVE TRANSFORMER MAKERS
Chicago, U.S.A.

INDEX TO ADVERTISERS

INDEX TO ADVERTISERS

	Page		Page		Page
A		I		R	
Acme Apparatus Co.	307	Illinois Stamping & Mfg. Co.	286	Radiall Co.	286
Aerovox Wireless Corp.	372	Imperial Radio Corp.	290	Radio Association of America.	306
Albin Radio Co., Inc., The.	262-286	Indianapolis Radio Exposition Corp.	306	Radio Corp. of America.	257
Alden Mfg. Co.	280			Radio Specialty Co.	279
All-American Radio Corp.	307	J		Radio World's Fair.	300
All Radio Co.	283	Jefferson Elec. Mfg. Co.	262	Randolph & Co.	262
Allen-Bradley Co.	260	Jewell Elec. Instrument Co.	292	Randolph Radio Corp.	274
American Bosch Magneto Corp., 266-267-281		K		S	
American Electric Co.	282	Karas Electric Co.	309	Seminole Co.	309
Amplion Corp. of America, The	306	Kelleradio, Inc.	290	Service Battery Co.	276
Amrad Corp., The, Inside Back Cover		Kellogg Switchboard & Supply Co.	273	Shure Radio Co.	303
Amisco Products, Inc.	284	Klosner Radio Corp.	309	Silver-Marshall, Inc.	285
Arrow Battery Co.,	284	Kodel Radio Corp., The 287-289-291		Smith, B. Hawley.	282
Atwater Kent Mfg. Co.	288	Konite Corp., The.	309	Southern Toy Co., Inc., The.	283
Automatic Fishpond Co.	280	Kurz-Kasch Company, The.	271	Starrett Mfg. Co.	268
Autostrop Safety Razor Co.	297	L		Sterling Mfg. Co.	296
B		Lancaster & Allwine.	268	Supertron Mfg. Co., Inc.	302
B. C. L. Radio Serv. Corp.	303	Lynch, Inc., Arthur H.	258	T	
Bakelite Corp.	290	M		Thordarson Elec. Mfg. Co.	195
Barawik Company, The.	288	Marko Storage Battery Co.	288	Tower Mfg. Corp.	193
Benjamin Electric Mfg. Co.	295	Masachusetts Radio & Tel. School.	307	Triangle Electric Co., The.	268
Birnback Radio Co.	258	Midwest Radio Corp.	286	U	
Bogue, B. N.	282	Mogul Electrical Labs.	262	Union Radio Corp.	302
Boudette Mfg. Co.	278	N		V	
Bradley Institute.	260	National Carbon Co.	259	Van Horne Co., Inc., The.	312
Brady, John B.	280	National Radio Institute.	197	Varick Elec. Co.	284
Bremer-Tully Mfg. Co.	307	Norden-Hauck, Inc.	202	Velvetone Radio Corp.	290
C		O		W	
C. E. Manufacturing Co.	307	Omnigraph Mfg. Co., The.	278	Westinghouse Elec. & Mfg. Co.	261
Camfield Radio Mfg. Co.	290	P		Willard Storage Battery Co.	269
Carborundum Co., The.	285	Pacent Radio Corp.	200-201	Wirt Co.	258
Carter Radio Co.	280	Parker, C. L.	274	World Battery Co.	302-305-306
Central Radio Labs.	274	Plymouth Rock Squab Co.	283	XYZ	
Chelsea Radio Co.	276	Precision Electric Co.	260	N-L Radio Laboratories.	286
Chemical Institute of N. Y., Inc.	294	Press Guild, The.	311	Yaxley Mfg. Co.	286
Chicago Radio Apparatus Co.	282	Prest-O-Lite Co., Inc., The.	275		
Chicago Salvage Stock Stores.	305	G			
Conrad Co., Inc., The 270-300-311		G-S Radio Research Labs.	274		
Cornell Electric Mfg. Co.	263	Gem Tube Co.	272		
Coyne Electrical Schools.	302	General Electric Co.	303		
		Golden-Leutz, Inc.	288		
		Goodrich Rubber Co., The B. F.	298		
		Gould Storage Battery Co., Inc., The.	283		
		Grigsby-Grunow-Hinds Co.	272		
		Guaranty Radio Goods Co.	277		
		H			
		Hawkeye Radio Co.	290		
		D			
		Daven Radio Corp.	284		
		Deutschmann Co., Tobe.	302		
		Distantone Radios, Inc.	292		
		Dodge's Inst.	302		
		Dongan Electric Mfg. Co.	284		
		Donle-Bristol Corp., The.	296		
		Dubilier Condenser & Radio Corp.	282		
		E			
		Easton Coil Co.	288		
		Electrad, Inc.	293-306		
		Electric Specialty Co.	298		
		Empire Electrical Products Co.	302		
		Eric Fixture Supply Co.	268		
		Evans & Company, Victor J.	258		
		F			
		Fansteel Products Co., Inc.	264-265		
		Ferbend Electric Co.	305		
		Ferguson, Inc., J. B.	280		
		Fishwick Radio Co.	268		
		Formica Insulation Co., The.	299		
		Freshman Co., Inc., Chas., Back Cover			

RADIO NEWS READERS' BUREAU

TEAR ALONG THIS LINE

Time and Postage Saver

IN every issue of RADIO NEWS you undoubtedly see numerous articles advertised about which you would like to have further information.

To sit down and write an individual letter to each of these respective concerns, regarding the article on which you desire information, would be quite a task.

As a special service to our readers, we will write the letters for you, thus saving your time and money.

Just write the names of the products about which you want in-

formation, and to avoid error the addresses of the manufacturers, on the coupon below and mail it to us.

If the advertiser requires any money or stamps to be sent to pay the mailing charges on his catalog or descriptive literature, please be sure to enclose the correct amount with the coupon. We will transmit to the various advertisers your request for information on their products.

This service will appear regularly every month on this same page in RADIO NEWS.

TO: READERS' SERVICE BUREAU,
Experimenter Publishing Co., Inc., 53 Park Place, New York, N. Y.

RN 9-26

FROM WRITE YOUR NAME and ADDRESS HERE:
NAME
ADDRESS CITY, STATE

Gentlemen: Please advise the firms listed below that I would like to receive detailed information on their product as advertised in the.....issue of RADIO NEWS.

 This form should not be used for technical questions

NAME	ADDRESS (Street — City — State)	List here specific article on which you wish literature.	If Catalogue of complete line is wanted, check in this column
.....
.....
.....

Check here if you are a dealer

Your Dealer's Name
Address

FREE!



“MEN! Here's the 'dope' you've been looking for-

HOW TO GET INTO THE RADIO BUSINESS”

J.E.S.

\$50 to \$250 a Week in Work That is Almost Romance

If you're earning a penny less than \$50 a week, clip coupon now for FREE BOOK! New book, profusely illustrated, tells all about the Radio profession, thousands of openings—in work that is almost romance! YOU can learn quickly and easily at home, through our tested, improved methods, to take advantage of these great opportunities! Why go along at \$25 or \$35 or \$45 a week, when you can pleasantly and in a short time learn to be a Radio Expert, capable of holding the big jobs, paying \$50 to \$250 a week?

Clip Coupon for Free Book

Don't envy the other fellow who's pulling down the big cash! Our proven home-study training methods make it possible for you, too, to get ready for a better job, to earn enough money so you can enjoy all the good things of life. Most amazing book ever written on Radio tells how—thousands of interesting facts about this great field, and how we can prepare you, quickly and easily in your spare time at home, to step into a big-pay Radio job. You can do what thousands of others have done through our training. GET THIS NEW FREE BOOK. SEND COUPON TODAY.

J. E. SMITH, President
NATIONAL RADIO INSTITUTE
Dept. KW-1 WASHINGTON, D. C.

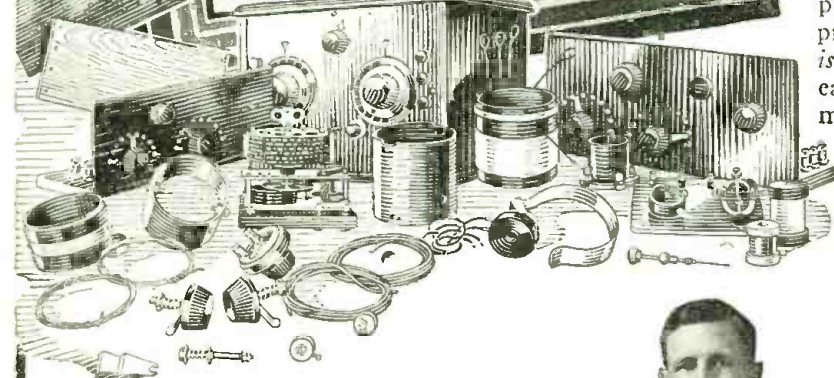

These Instruments FREE of Extra Cost

All instruments shown here and others—SIX BIG OUTFITS—sent to all our students free of extra cost under short-time special offer. Clip coupon now—find out all about this big unequalled offer while you still have time to take advantage of it. Our training is intensely practical—these instruments help you learn to do the practical work. Receiving sets, from simplest kind to thousand-mile receiver. Many other big features.



J. E. SMITH
President

My Radio Training Is the Famous “Course That Pays For Itself”

Spare time earnings are easy in Radio when you know it the way we teach you. Increase your income almost from the start of your course thru practical knowledge we give you. We show you how to hold the job, then our big Free Employment Department helps you get one. Free book “Rich Rewards in Radio” tells how.

Howard B. Luce of Friedens, Pa., made \$320 in 7 weeks during his spare time. D. H. Suitt of Newport, Ark., writes, “While taking the course I earned in spare time work approximately \$900.” Earl Wright of Omaha, reports making \$100 in a short time while taking his course—working at Radio in his spare time only! Sylvester Senso, 207 Elm Street, Kaukauna, Wis., made \$500.

And when your training is completed you're ready to step into a real big Radio job like C. C. Gielow, Chief Operator of the Great Lakes Radio Telegraph Company; E. W. Novy, Chief Operator of Station WRNY; Edward Stanke, Chief Operator of Station WGR; and hundreds of other N. R. I. Trained men. The National Radio Institute, oldest and largest Radio home-study school in the world today offers you the same opportunity these men had, under a bond that guarantees you full satisfaction or money refunded. It's your big chance to get into Radio—mail coupon for FREE Book and proof.

NOW! Special Short Time Offer 6 BIG OUTFITS

Radio Needs Trained Men

National Radio Institute
Dept. KW-1
Washington, D. C.

Dear Mr. Smith:

Without obligating me in any way, send me your big FREE BOOK, “Rich Rewards in Radio,” and all information about your practical, home-study, Radio Course.

SEND THIS COUPON TODAY

Name

Address

Town State

5 tube SINGLE DRUM

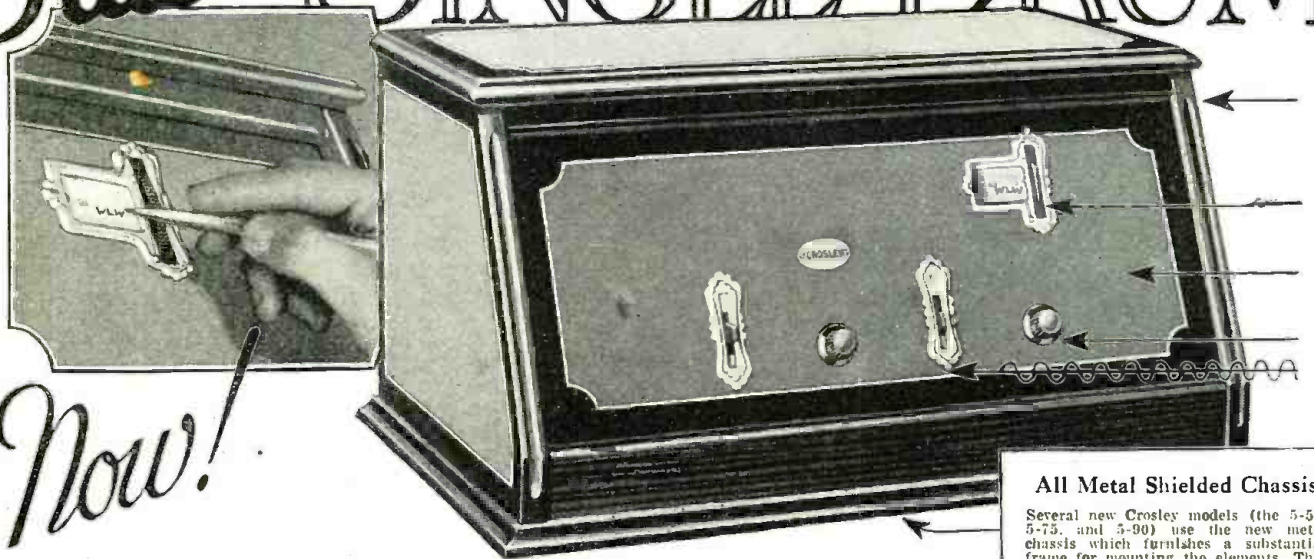

Now!

Single Control and Selectivity

Amazement and delight will seize upon you the instant you contrast the surpassing performance of this new type of Crosley Radio with what has hitherto been considered radio perfection.

And you may well stand dumbfounded to find 5 tubes with single control embodied in its Drum Station Selector, the sharp tuning feature of its Acuminators, its adaptability to power output tube, and its beautiful appearance . . . in a radio set for \$50!

Crosley mass production reaches its highest peak in giving the world this incomparable value. So magnificent are the radio engineering achievements in this new model that the price is positively astonishing.

The cabinet is solid mahogany, beautifully finished in two-tone and striped in gold. Metal fittings are rose gold finish.

Never before such an astounding Crosley value. See it—hear it—operate it yourself—at any Crosley dealer's . . . now.

All Metal Shielded Chassis

Several new Crosley models (the 5-50, 5-75, and 5-90) use the new metal chassis which furnishes a substantial frame for mounting the elements. This effects excellent alignment of the gang of condensers, as well as affording a mounting for a rheostat, acuminators, crescenton, coils, sockets, transformers and insulation terminal strip. This metal shielded chassis is divided into three compartments. Thus the units shielded from each other prevent interstage as well as external coupling.

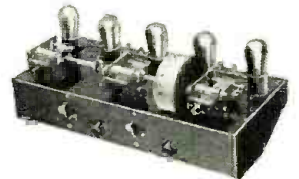

This improves the stability of the circuit and increases the selectivity as well. The metal shielded chassis is indeed a most progressive step in advanced radio design. This feature has never been offered before in sets of moderate price.

The Musicones—

The announcement of the new Super-Musicone is predicated on the success of the Regular (12 inch cone) Crosley Musicone in replacing hundreds of thousands of old type loud speakers. (Keep in mind that it's the exclusive Crosley patented actuating unit and *not* the cone that makes possible its wonderful performance). 12 inch Musicone Regular *now* \$12.50.

The Crosley Super-Musicone (16 inch cone) is considered by some to develop more resonance in bass reproduction and is naturally louder than its 12 inch counterpart. Beautifully decorated both in front and on the back. Price \$14.75.

The MUSICONSOL into which the Musicone has been skillfully built, holds all batteries, wires and accessories. Two-toned mahogany finish. 24 1/2 inches long inside. Price \$32.

Crosley Musicones are manufactured under basic patents issued and pending, controlled by Crosley. Prices slightly higher West of the Rockies. For descriptive catalog write Dept. 22.



THE CROSLY RADIO CORPORATION, Cincinnati

Owning and operating WLW first remote control super-power broadcasting station in America.

Crosley manufactures radio receiving sets which are licensed under Armstrong U. S. Patent No. 1,113,149 or under patent applications of Radio Frequency Laboratories, Inc., and other patents issued and pending.

CROSLY

[STATION SELECTOR] RADIO RECEIVER

SOLID MAHOGANY CABINET

Graphic Station Selector

All stations found instantly on this one single control. It revolves smoothly under slight pressure. Once stations are found, they are easily written on the drum. No log book to fuss with. Stations from one end of the wave band to the other are easily brought in at all times—IN THE SAME PLACE. This advanced improvement in station finding has heretofore been found only in the highest priced radios.

POWER TUBE ADAPTABILITY

Creseendon Control

This exclusive Crosley feature supplies very unusual volume from distant stations. In cases where on ordinary radios ears must strain to catch the station many leagues away, the turn of the Creseendon on a Crosley swells the reception to room-filling volume. This Crosley feature has already given great satisfaction in the 4-29 and 5-38 models brought out early this year.

Acuminators

(From "acuminato", meaning "to sharpen")
Heretofore single dial control sacrificed selectivity. It was practically impossible for sets located near broadcasting stations to tune them out and bring in distant stations. By means of these Acuminators, very sharp tuning is accomplished where the reception from stations spreads broadly over the dial. Under average conditions, when once adjusted, these acuminators do not have to be touched again.

\$50.



5-TUBE SINGLE CONTROL RADIO
Priced without accessories

Crosley 1927 radio achievements fit all purses

At \$9.75

The little double-circuit single-tube "Pup" has already brought happiness to thousands. If the thousands of reports sent to Crosley last winter are any indication, probably the greatest distances over which laymen have ever heard radio signals have been with this set.

At \$29

The 4-29—a 4-tube receiver of amazing efficiency. Such radio performance has never before been possible at such a low price. Brought out early this season it quickly proved its right to a permanent position in the Crosley line. Creseendon equipped.

At \$38

The 5-38—this 5-tube tuned radio frequency set incorporates two stages of non-oscillating radio frequency amplification, regenerative Creseendon controlled detector and two stages of audio frequency amplification. Sales and performance since its introduction

mark the 5-38 as a spectacularly popular model and one of Crosley's most startling values.

At \$65

The RFL 75—true cascade amplification; non-oscillating—non-radiating, regardless of how it may be mishandled. This perfect balancing is achieved by introducing the Wheatstone bridge into each stage of amplification—a clever engineering feature instantly recognized by radio technicians—and appreciated by the laymen because of the selectivity and tone this set affords.

At \$75

The 5-75—Crosley's new console radio—embodying the 5-tube single control with drum station selector as offered in a table model at \$50. SOLID MAHOGANY cabinet into which is built the Crosley Musicone. Ample compartment for batteries. Stands 41 inches high. Beautifully finished in two tones.

At \$90

The RFL-90—the console model of the \$65 RFL circuit, introducing the double drum station selector! This is a fine radio engineering achievement offered in a beautiful housing of solid mahogany, finished and decorated so exquisitely as to grace the finest surroundings. MUSICONE built in—ample room for batteries and all accessories, 41 inches high, 30½ inches wide.

Prices slightly higher West of the Rockies. For descriptive catalog write Dept. 22.

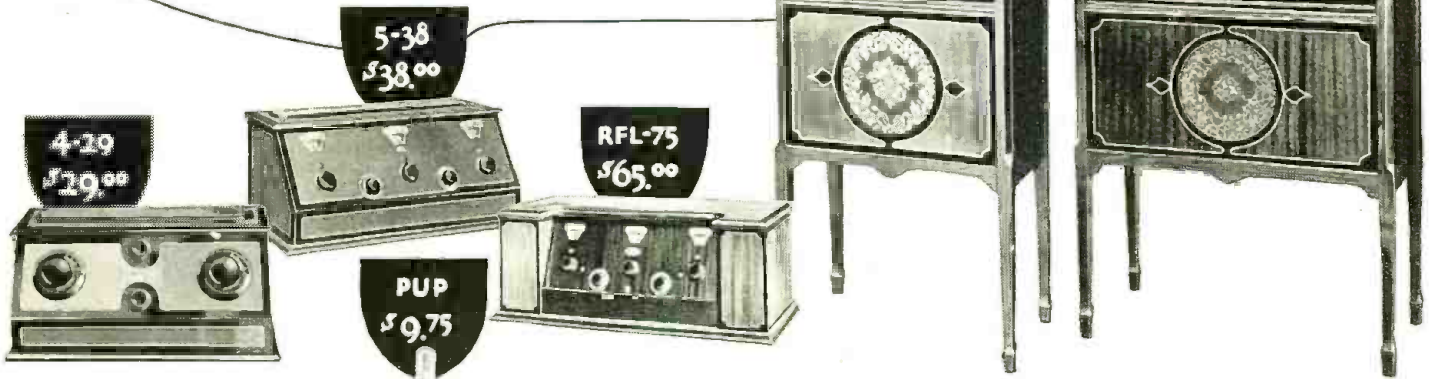

RADIO

**BETTER
COSTS
LESS**

A New Day Has

Radio Reception has been revolutionized. Like magic, your receiver can be transformed from a mere mechanical contrivance to an instrument of pure, powerful tonal quality with a range of sounds from a whisper to a roar.

Hear the
Powerformer

THE POWERFORMER

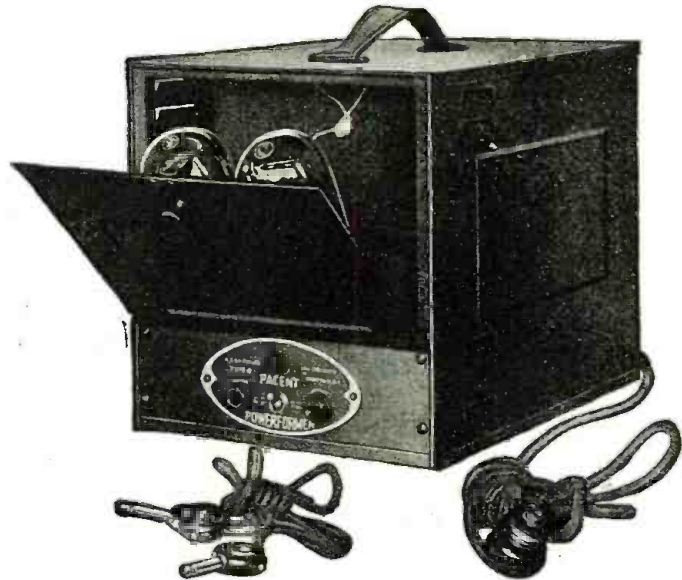

The finest Sound reproducing instrument and a "B" Eliminator too.

It is no exaggeration to say that with the development of the Powerformer by a group of engineers under the direction of Louis Gerard Pacent, a new day has dawned in radio. This device, the result of several years of painstaking research, literally takes the delicate inflections of the human voice and the finest shades of the violin and reproduces them without in any way altering their delicacy or introducing the slightest harshness.

The clash of the cymbals, the timbre of the bell and the deep boom of the bass drum are recreated in all their original fidelity. And by simply plugging into your electric light socket or outlet the Powerformer acts as a "B" Eliminator, eliminating the unsightly and inconvenient "B" batteries, and substitutes at a cost too negligible to be considered, a continual, silent, even, and never decreasing source of "B" current.

List price
(exclusive of tubes but including all necessary connections)—\$82.50

The following are required:

- 1 UX-216-B or CX-316-B Rectifying Tube.
- 1 UX-210 or CX-310 Amplifying Tube.

PACENT RADIO CORP., 156 West 16th Street,
NEW YORK, N. Y.

Pacents products are sold everywhere. If you cannot obtain them in your locality write direct.

Dawned in Radio

THE PACENT CONE

Licensed under Lektophone Patents

(Dated July 2, 1918)

Other Patents Pending.



Fidelity of Reproduction, Pitch, Volume and Clarity

In line with the intensive study of instruments for improving audio reproduction, the Pacent Engineers have achieved a truly masterful Cone Speaker. This Cone is a decided advance in Speaker quality—giving *absolute* fidelity of tone and reproducing a range of sounds which includes bass and soprano notes hitherto unheard by listeners.

It is correct from every engineering standpoint with a balanced armature, double Cone, specially selected brown grained prepared paper. It is rigidly constructed and so designed as to take extreme power-amplified signals and yet be sensitive enough to respond to weak signals. The Pacent Cone is beautifully proportioned, presenting a harmonious, blending appearance wherever placed.

- TYPE A Pacent Cone 17 inch (stand type) \$28.50
\$31.50 West of Rockies
- TYPE WA Pacent Super Cone 36 inch. (wall type) . . \$65.00
slightly higher West of Rockies
- TYPE SA Pacent Super Cone 36 inch (stand type) . . \$79.50
slightly higher West of Rockies

PACENT RADIO CORP., 156 West 16th Street,
NEW YORK, N. Y.

Pacent products are sold everywhere. If you cannot obtain them in your locality write direct.

By specializing only in audio, or the sound reproducing instruments, The Pacent Engineers have developed products that have established a new day in Radio reception. The use of these products in, or in conjunction with, any set will improve it beyond all description.

Hear the
Pacent Cone

A New and Advanced Model



Panel Size: 36"x9x1-4"

Weight: 55 lbs.

NORDEN-HAUCK Super-10

THE NORDEN-HAUCK SUPER-10 is an entirely new and advanced design of Receiver, representing what we believe to be the finest expression of Modern Radio Research Engineering. It is the product of years of experience devoted exclusively to the attainment of an ideal Broadcast Receiver—regardless of cost.

Results obtained in every respect will upset all your previous ideas of good radio reception.

Here are only a few of the host of features that place the NORDEN-HAUCK SUPER-10 far in advance of competition:

- 10 tubes employed to give perfect reproduction with unlimited range and volume power.
- Super selectivity on all wave lengths.
- Built to Navy Standards.
- Wide wave length range without change of coils, 200-550 meters full. (Adaptable 35 meters to 3600 meters if desired).
- Use Loop or Antenna.
- Simple to operate, having only two major tuning controls.
- No Harmonics. Signals are received only at one Point.
- Special Power Audio Amplifier, operating any loudspeaker and eliminates necessity of external amplifier.
- Can be operated directly from house current if used with NORDEN-HAUCK POWER UNIT AB-2. Special.

Write, Telegraph or Cable Direct to

Norden-Hauck, Inc.

ENGINEERS

Marine Building

Philadelphia, U. S. A.

TEAR OFF AND MAIL TODAY

NORDEN-HAUCK, Inc.
Philadelphia, U. S. A.

Gentlemen:—

- Please send me without cost or obligation on my part, attractive illustrated literature describing the new Norden-Hauck Super-10.
- I enclose \$2.00 for which please send me, postpaid, complete full size constructional drawings and all data for building the Super-10.

NAME

ADDRESS

The NORDEN-HAUCK SUPER-10 is available completely constructed and laboratory tested, or we shall be glad to supply the complete engineering data, construction blue prints, etc., for those desiring to build their own receiver.

UPON REQUEST a complete catalog, attractively illustrated, will be gladly mailed without charge, or full size constructional blue prints, showing all electrical and mechanical data, will be promptly mailed postpaid upon receipt of \$2.00.



RADIO NEWS

H. GERNSBACK, Editor and Publisher
SYLVAN HARRIS, Managing Editor

EDITORIAL AND GENERAL OFFICES, 53 PARK PLACE, NEW YORK

Vol. 8

SEPTEMBER, 1926

No. 3

IS RADIO AT A STANDSTILL?

By HUGO GERNSBACK

DURING the course of conversation with many people in all walks of life, the question is frequently asked me, if radio has now settled down, in the same degree as the automobile industry, and whether it has become stabilized?

I have answered, a great many times during the past few years, that we need not look for any revolutionary improvements in radio at the present time. The chances are against any invention that will entirely upset the radio industry. Just as in the automobile industry, we may not look for any revolutionary invention that will upset the entire trend of the automobile—unless it should be a flying attachment, which might be applied to any automobile—and this, while not impossible, nevertheless will not appear in the immediate future.

It is the same with radio. Television to be sure, is in the offing, but several years will elapse before you will be able to sit before your radio at home and witness a baseball game 100 miles distant. On the broadcasting end, no great and epochal improvements need be expected shortly. While improvements are being made right along, these are now more in the nature of finer touches rather than revolutionary; but we can expect better and better transmission and greater clarity. One of the great troubles in the United States at the present time is the heterodyning between different stations nearly on the same wave-lengths. This is particularly true of the low wave-lengths, where there is serious congestion, and there does not seem to be any immediate remedy for this. Technically, there seems to be no possible way to separate two stations less than 1,000 miles apart and operating on the same wave-length. As Congress has adjourned for some six months, and the Department of Commerce is left with little authority, there seems to be little hope that the heterodyning evil can be done away with in the immediate future.

On the receiving end it does not seem that sets will be altered radically during the next few years. Five- and six-tube sets probably will prevail for quite a long time to come; although there is always the possibility that a single-tube super-regenerative set, which in output may equal the present 4- and 5-tube set, can be developed. So far the super-regenerative circuit, while admitted to be one of the great possibilities, has been and remains nothing but an experiment. It is, as yet, too tricky and has never left the laboratory stage.

From these remarks no rash conclusions should be reached that radio is stagnant and does not progress. Quite the contrary. During the entire year of 1925 over nine hundred radio patents were issued by the Patent Office; and during the first six months of 1926, almost six hundred radio patents have been issued. As a matter of fact, it will be seen from these figures, our inventors in the various laboratories all over the country are still tremendously busy devising new and better things in radio. It would seem that this activity should keep on increasing rather than decreasing in the immediate future.

Radio in this country goes through various strange cycles. When broadcasting started off with a rush, we were in the crystal-set stage. That prevailed during some six months, until the single-tube epidemic set in, which lasted for a year. With one bound we jumped from the single-tube to the 5-tube set which, even today, is more or less standard. At first the

sets were built in a box to put on the table. That continued for about a year, when the industry was affected with the console-set fever, which does not yet seem to have abated.

As to the parts,—components—conditions were much the same. Last year we saw a small epidemic of straight-line-frequency condensers, which have practically displaced the old straight-wave type. Then came the vernier-dial tempest, which is still blowing strong.

This year seems to be an "A" and "B" eliminator year; because more firms are becoming engaged in the manufacture of eliminators than in possibly any other single radio accessory. There are several million radio sets in use today, and the market for batteries and "A" and "B" eliminators is therefore very large. As in all such phenomena, there is sure to be a race for supremacy between the manufacturers of eliminators and those of batteries. And we may be certain that the battery people are not standing by idly.

When radio first came along, it seemed that the deathknell of the phonograph had definitely been sounded; but the phonograph people merely rolled up their sleeves and went to work producing such phonographs as they had never before believed it possible to build. The immediate result was that the phonograph today is in far greater demand than it was before the advent of radio; and, whereas in 1922 every phonograph manufacturer had "nerves" every time the word "radio" was mentioned, he sits back today, complacently, and is not worried at all.

So it will probably come about that the battery manufacturers will be spurred on to meet the invasion and give the eliminator people a stiff battle. Already the storage-battery folk have seen the light, and are putting out radio power plants that connect right to the lighting circuit. These miniature power plants give "A" and "B" battery current with a minimum of attention from

the owner. No longer is he required to lug around heavy "A" and "B" storage batteries; now he leaves the unit in the cellar and it is charged automatically.

As to the radio sets, they are getting better and better as time goes on. More attention is being paid now to reduction of losses, shielding, and mechanical perfection, than at any time during the history of radio. It is safe to say that an up-to-date set bought today will be in service for many, many years to come. In the meanwhile, the sets are becoming more sensitive as well, and will have better and better range, by virtue of the improvement in vacuum tubes, which are being made more sensitive every month. Not only are they more sensitive, but they are being made more economical as well. The 5-tube set in 1920 required 5 amperes at 6 volts, which is 30 watts, to light its filaments. It meant, then, recharging your storage battery every few days. The like set today uses only about 1¼ amperes at 5 volts, or 6¼ watts. It is safe to say that the consumption of current by the average radio set, at the end of the next five years, will not be even half what it is today.

During the coming season, the shielding idea seems possibly the greatest advancement in radio receiver building. More and more firms are adopting the shielding system, whereby coils, tubes, and condensers are completely shielded by metallic containers, to do away with stray currents set up not only within the set itself, but from outside sources. This results in much sharper tuning and very much better reception.

... wherein the editor compares the Radio Industry to the Automobile Industry—in which the gradual evolution of radio is sketched—how it is shown that the rate of radio patents is increasing—in which batteries and eliminators are discussed—and why radio sets use five times less energy now than in 1920.

Mr. Hugo Gernsback speaks every Monday night at 9 P. M. from Station WRNY on various radio and scientific subjects.

How to Make Radio Pay Your Way

By C. WILLIAM RADOS

Some of you may have wondered how you could make money out of radio, during your spare moments, or as a steady profession. Mr. Rados presents herewith an article telling many ways in which it can be done.

IT seems to be a characteristic opinion—among amateurs, operators, dealers, writers and others—that there is very little money to be made in radio. They grouch around in the "off" season, wondering what is the matter with them. The only reason they do not enjoy good incomes is that they do not realize their opportunities, and push them to the limit by hard and steady work.

Some of the possibilities for turning radio knowledge to good account are listed in this article. If used to the fullest extent of depending on them for a living, they will pay your way.

"Servicing" is the easiest way to start. It requires only a small outlay for tools and advertising, and only "handy man" knowledge. It consists in keeping the broadcast listener's radio set in excellent working condition. His batteries may need charging, his loud speaker cord may have a broken connection, or his aerial may have blown down. These little things are almost innumerable; and the average set owner knows nothing about radio or how to fix his receiver. He will call up the service man on the least provocation.

You should have a card with fixed prices for each item, with your address and phone number. Leave one at each house and build up a patronage. In order to get a large business you will have to advertise; this can be done quite inexpensively in the local paper, if you are in a small town. If you have a good mailing list of set owners, direct-mail methods can be used to distribute your circulars very effectively.

PERIODICAL OVERHAULING

The average radio set needs servicing at regular intervals—an important fact which

has been overlooked by a good many owners. You must stress the importance of having the radio set gone over regularly, just as the automobile must be.

Battery charging is a specialty on which you can concentrate for a spare-time job, as it takes very little time. The majority of the millions of installations have storage batteries, but no charger, so that they pay \$2 to a shop for charging. Here is where you step in; when a call comes, take with you a charger, connect it, and tell your customer to turn on the switch when he retires. In the morning you collect your charger and depart with your money. In a few weeks, with advertising and good will, you can find enough business to keep several chargers working continuously. Remember that the battery must be frequently charged and you can assure yourself of steady customers.

CORRECTING AND ADDING TO INSTALLATIONS

In almost every installation will be found one or more instances of failure to comply with the underwriters' rules. Strict adherence to these is required by the insurance companies, who will cancel a policy, or more often, exact a higher rate. Every time you see an installation which is imperfect in this regard, call it to the attention of the owner and stress the importance of complying with the rules. Most people will engage you to rearrange the wiring, if it does not cost more than a few dollars. Notice particularly that fuses are required for storage batteries, a point generally overlooked. For details, see the "National Electrical Code" of the National Board of Fire Underwriters. When you show this to customers, there will be little hesitation about having you correct the faults.

Something which will require a little more ability is increasing existing installations. Most single-family houses have one set and one loud speaker. It is a simple job to make two or three extensions to places about the house, with an outlet at each, thus allowing the use of the loud speaker at any of them. In the summer, for instance, it is convenient

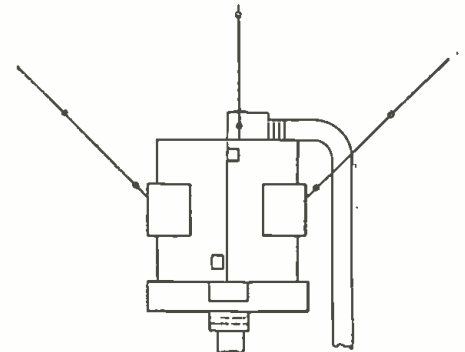

FIG. 1—THREE AERIALS FROM A THREE FAMILY HOUSE—PLAN VIEW

It will be noted that the three aerials are strung at oblique angles to each other. If the roof is large they could be erected there and run parallel.

to have the horn on the porch. This should be kept in mind when installing a set in the first place. Thus the set is placed where the aerial and ground connection are best and most direct; and the loud speaker can be used anywhere, as most convenient.

Something further is the operation of more than one speaker from a set, which is occasionally wanted; and you should understand this. Technical details have been given in past issues of RADIO NEWS.

MULTIPLE INSTALLATIONS

In two- or three-family houses you will find many times that each tenant has a set and aerial. The roof or yard will present an untidy appearance with wires strewn about. There are two ways to correct this; one a single, neat, well constructed aerial from which two or three receivers may be operated simultaneously. The other is the use of individual aerials, as shown in plan view in Fig. 1. Make each of a different length, but well constructed, sturdy and neat. If a large, flat roof is available, they may be erected parallel to each other.

Another detail suggests itself; for a small house or apartment, the storage battery should be put in the cellar with the charger, necessitating only two small wires run to the set. For these small jobs you should have a standard price.

It is easy enough to earn money making installations in private homes, but another class can be made to yield good dividends. If you are something of a carpenter and general mechanic, as well as electrician, you will find the larger installations very lucrative. You must be able to talk to architects, builders and real estate men, to interest them in radio from its financial side; they look at it from the standpoint of business men.

A hotel or large apartment building should have two or three receivers, located at some central point; every room having a loud speaker outlet. This gives the guest or tenant the choice of two or three stations. One receiver will have a loop for locals; the

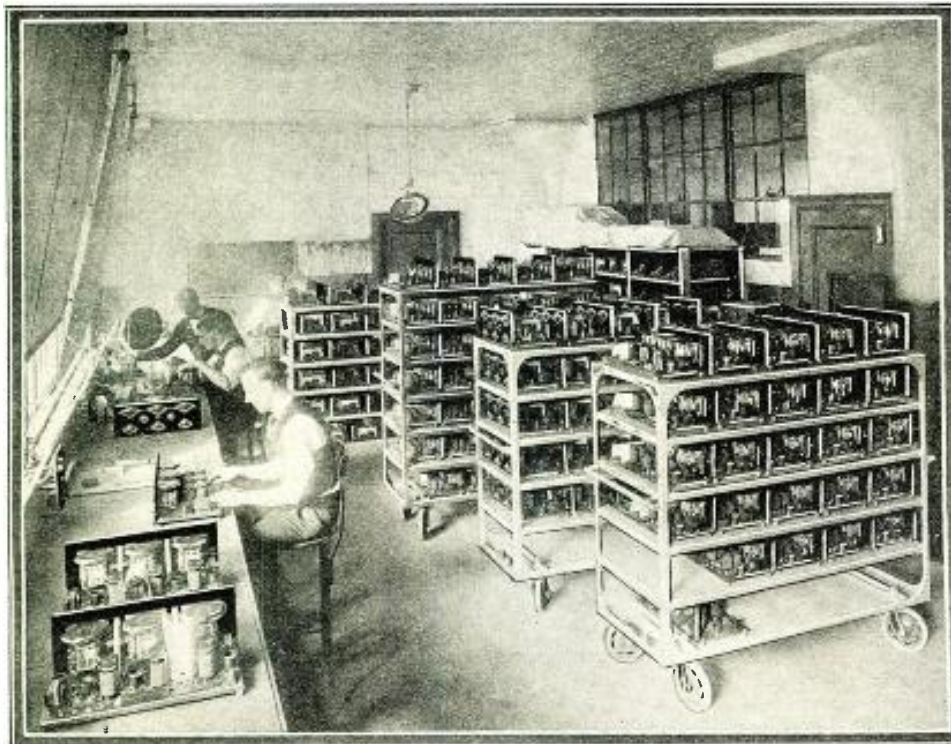

In a plant like this the radio man may learn the best practice and use it to his own advantage later for experience. Positions in practically every division of the field are offered to the man who is capable of beating his own path.

Photo by courtesy of A. H. Grebe & Co.

others outdoor aerials for greater distance. Fig. 2 suggests how the wiring may be done. Three receivers and three powerful amplifiers are needed, together with a panel, to which each loud speaker socket is connected. It will be seen from the figure that each of the sets can be connected to any of the speakers. But when you must connect thirty speakers to one set, care is required, though no real difficulty is presented. The jack connections on the board will depend on the speakers; which will be connected in series and parallel, depending on the load. The supply company from which you purchase your equipment will furnish you the necessary data.

The cost of such an installation will be about \$2,500; the receiving sets will cost about \$500 apiece, including power amplifier; as they must be of a substantial commercial type. The usual price for such wiring is \$6 to \$8 an outlet; if you purchase sufficient equipment, you will rate dealer's discount. The distributing board may be purchased or built on the job.

Other installation work is possible on automobiles, yachts and motor boats, etc. In some of the western states, radio is used in school houses, both city and country. These usually consist of a receiver, aerial and speaker and are easily put in. Hospitals should have two or three separate installations: as they have usually extensive grounds, there is plenty of room for well-spaced aerials. These are profitable jobs; reliable and sturdy equipment must be used, but the contract is large and will repay you well for your work. The same installations might be suited to churches, but it will probably be better to overlook them, as they have little money and your margin is apt to be turned into a loss.

BETTER AERIALS

The usual small apartment house cannot afford the elaborate installation of central receivers; if every family can be persuaded to use loop receivers, the result will be more

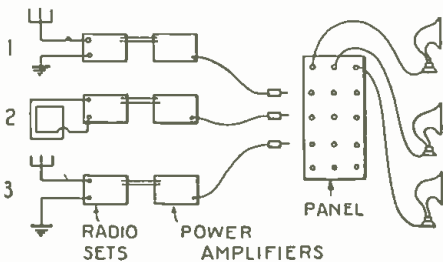

FIG. 2

Installation arrangements for apartment houses or hotels; a loud speaker is provided for each family. Any of three programs can be listened to, with the separate receiving sets.

harmonious. But most will want a roof aerial. Erect sturdy masts at each end, run the wires parallel, and you will make a neat and legitimate job. Fig. 3 shows the idea.

A big talking point which will make quite an impression on the owner or his agent, is the fact that rearrangement of the roof "jungle" will improve the looks of the structure and comply with the insurance code. If aerials are not wanted you can put up a Taylor multiple antenna, a device for using many sets from one aerial. If the owner vetos this, install indoor aerials or use tight socket attachment plugs.

If you are competent to do large installation jobs, you will find that many customers will want you to build them receivers; you will do well to advertise in the spring that you will build sets for camps, and other special purposes. Once in a great while some one will want a transmitter built. Small amateur CW, and phone sets are occasionally desired by those who want to break into the "ham" game. Some radio dealers have a sideline of renting sets to campers and summer cottagers.

RADIO OPERATING

Though the idea immediately suggested by this is ship and commercial station operating, the field is wider. Operating in apartment houses, hotels, schools, and the like will take

from various sources is part of the radio doctor's practice; and is well paid, if your fees are high enough for the technical skill required in this work.

Designing and testing for small manufac-



There are plenty of opportunities open in retail radio stores and they are excellent places to get general experience. It is easy to branch out into service or installation work; the practical experience gained is worth it.

©Herbert Photos, Inc.

only a few hours in the evenings; and requires handling a few sets and keeping them in condition. This is excellent for the student, as the money is extra, and there is an opportunity for study on the job.

In every city there will be many places using operators; some years ago the writer worked (?) for a railroad office and found it necessary to do very little to earn the money. Banks, hospitals, department stores are potential sources of income; there is another opportunity if a large convention comes to your city.

The field of ship and commercial station operating is limited, and ship operating never pay a large salary; but for a life profession, the shore stations pay their operators well. If you have the broadcast operator's license, you may get a job as part time operator with some broadcast station.

An independent service which you can supply is that of running lines and microphones to athletic meets, halls and other gatherings which are to be broadcast by radio; this, of course, is limited to the small cities where the telephone company has little radio business. A store in the center of the town may wish to advertise by reporting some interesting event. You install a small portable amateur phone at the field and have an amateur receiver at the store.

Such stunts are common, but if you can earn a \$20 bill for a day's work, it will make no difference to you how common it is. Coast guard operating may furnish a humble start for some boys possessing only second-class licenses.

THE RADIO DOCTOR

The radio doctor is called on to cure poor radio reception, weak signals, fading, etc. Some of these are easily cured, and others not. For weak signals caused by a small aerial, add a tuned coil to the aerial, thus tuning the primary. The reader who has not tried this has a surprise coming in the way of loud signals. Installing wave traps, "B" eliminators, and power amplifiers, bringing single-circuit tuners up to date, taking the curse out of "squealers," and generally shooting trouble, fall to the lot of the radio doctor. Discovering and curing interference

turers is another line of work that should pay from \$3 to \$6 an hour. You will notice in every store dozens of articles made by little concerns, operating on a small scale. The student radio engineer and laboratory man will find an excellent opportunity in getting on the staff of one of these companies. He can test, redesign and give consulting service for a few dollars an hour, and they will benefit by retaining a technical man as adviser.

Radio has not reached perfection, by any means; if you have an idea about anything in radio, put it to the test as soon as possible. If you have anything slightly different from the usual, put it to the test as soon as possible. The writer knows a man who made \$5,000 one season by showing manufacturers how to turn out cheap 5-tube 3-dial sets for the Christmas trade. So if you have any ideas, see different business men and present the possibilities.

THE RADIO STORE

This subject is well covered by the trade publications; but here are a few words of advice for the younger element. If you are of a national descent or race which can be capitalized in attracting trade from those of similar extraction, do this.

This will be found of special value in winning the confidence and the business of those to whom you can talk in their own manner, when it comes to a subject they understand so little as radio.

(Continued on page 262)

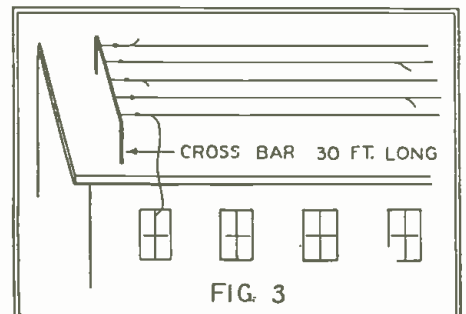

FIG. 3

A neat arrangement for a number of aerials on the roof of an apartment or hotel building.

Television An Accomplished Fact

By A. DINSDALE

This authorized description of the television apparatus invented by J. L. Baird will be of the greatest interest to those who wish to keep abreast of radio's latest developments.

FOR the last twenty years the editor has published from time to time, various articles on Television, beginning first in MODERN ELECTRICS in 1908, and during the past few years through RADIO NEWS.

All these articles were of a theoretical nature, as Television was not at that time an accomplished fact. The editor came in for a good deal of criticism and was termed visionary on account of these articles.

Our faith in Television, however, was sufficiently persistent; and we believe that we will not be contradicted if we say that RADIO NEWS, in connection with its associated magazines, has published more articles on Television than any other agency.

And now, Television is an accomplished fact. The art has progressed to such an extent that it is possible to see a moving face at a distance and to actually, visually, witness a thing that takes place at a distance. This is true Television. The editors themselves were skeptical when they first heard about the Baird Television Apparatus and commissioned Mr. Dinsdale, who is a member of the Radio Society of Great Britain, to get the actual facts on it, which we now publish in an authoritative form.

Without trying to be over-enthusiastic or visionary, we wish to say now that Television will change our entire mode of living just as the Telephone, the Telegraph, and the Railroad changed our lives when they came into general use.

FOR some years past we have become accustomed to "listening in" by radio to audible sounds produced at some distant point, which may be anywhere up to several thousands of miles away. How long will it be before we are able also to "see in" by radio, and thus witness scenes and events at places similarly distant from us? In view of the vast progress recently made in this direction, the writer ventures to express the opinion that it will not now be very long before this comes to pass.

The cinematograph has been developed within the last twenty years or so, till today it is a highly-efficient and marvelous means of entertainment; but it is one-sided. Its appeal is to the eye only. We see a great actress speak, but we cannot hear her words. Many inventors have been working for years

to make this possible, but it is not yet a commercial accomplishment.

As with the cinematograph, so with broadcasting as we know it to-day. We can hear a great man speak, but we cannot see his gestures and facial expressions. It is the province of Television to overcome this disability. By combining television with ordinary broadcasting, we shall, in the near future, not only hear the performance of a play, but also see the actors, the scenery, the entire stage.

REPRODUCTION OF SIGHT

That is the function of television. It must not be confused with telephotography, which is something totally different. Telephotography, or phototelegraphy as it is sometimes called, means the telegraphic transmission of a single "still" picture from one place to another.

In Webster's dictionary television is confused with phototelegraphy, and if such an authority is in confusion, there is no wonder that the public—even the technical section of it—does not possess clear ideas on the subject. It needs no apology, therefore, to commence an article on television with an attempt to define exactly what television is, and for an authoritative statement, we cannot do better than quote the British patent office, whose business it is to define and catalogue such terms.

In the patent office library we find classed, under the heading "Television," "Apparatus for transmitting instantaneously to a distance images of views, scenes or objects by telegraphy (either wire or wireless.)" In other words, Television means seeing at a distance by telegraphy.

Until recently, our only means of extending our range of vision beyond normal distances was the telescope; and the range of this instrument is distinctly limited. The develop-



Mr. Baird demonstrating the receiver of his television apparatus, seen in the circle.
© London News Agency.

ment of television will enable us to see scenes and objects at distances as great as those over which we are now accustomed to communicate telegraphically and telephonically.

HISTORY OF DEVELOPMENT

Both phototelegraphy and television are no new ideas. The latter is but a development of the former; and the inspirations for both date back to 1873, when May, one of Willoughby Graham's assistants, communicated to the Society of Telegraph Engineers the details of his discovery of the photo-electric properties of selenium.

It was not long before this discovery led to the construction of selenium cells by Siemens, Graham, Bell and others. These, as all the world knows, are devices for transforming light impulses into electrical impulses; and the idea soon occurred to a number of investigators that they might be utilized to give to the eye what telephony had given to the ear, and render it possible to see by telegraphy.

Ayrton and Perry, Senlec and several others actually described systems which were to accomplish this; and nearly fifty years ago it was confidently predicted that in a very short time it would be possible for us to see one another over the telephone line!

These optimistic inventors had, however, entirely overrated the capabilities of selenium to respond to the immense speed of signalling involved; and their predictions came to nought, as far as practical results were concerned. Considerable progress was made in phototelegraphy, however; for time is a secondary consideration in the transmission of a single still picture, and the various other problems in connection with this accomplishment are considerably easier of solution.

At the present time many investigators in various countries have demonstrated their ability to transmit and receive still pictures, either by wire or radio; among whom may be mentioned C. Francis Jenkins in the United States, Thornton Baker in England, Fournier and Belin in France, and Dr. Korn in Germany. Also worthy of mention is the more recent achievement of Captain Ranger of the R. C. A., who succeeded in sending a photographic copy of a check from London to New York in 25 minutes.

Phototelegraphy, therefore, is not only a definitely accomplished fact; it is also a commercial proposition. Television, however, has not made anything like such progress; for only one inventor has so far succeeded in giving an actual demonstration of "seeing at a distance."

SOME PROBLEMS OF TELEVISION

Most of the systems in use for transmitting still pictures make use of the cylinder method; in which the picture to be transmitted is transferred to a film, which is wrapped round a cylinder of glass. As this cylinder is rotated, a spot of light is caused to cover the



Capt. O. G. Hutchinson, president of Television, Ltd., is shown at the left; while above is an untouched photograph of Mr. Hutchinson's image taken at the receiving screen of Mr. Baird's television apparatus.

© International Newsreel.

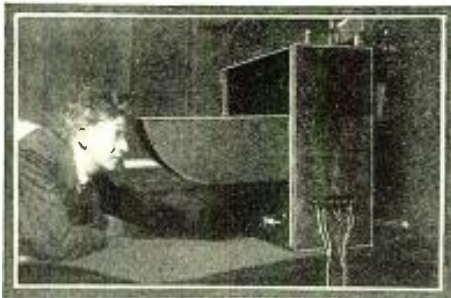

Mr. Baird "seeing-in" on one of his experimental televisions.

film from end to end in a series of finely separated lines. The intensity of the light which passes through the film depends upon the latter's density at different points; and the varying light beam, after passing through the film, is focused upon a light-sensitive cell, of one or another type. This cell transforms the light variations into electric-current variations, which are sent over a wire or by radio to the distant receiver.

At the receiving end the process is reversed, the incoming current variations being caused to vary a source of light which is focused upon a photographic film wrapped around a rotating cylinder. This film becomes covered with fine lines of varying density, which, when developed in the usual manner, make up the complete picture.

Obviously, this system is inapplicable to television, for a scene, or even the image of it, cannot be wrapped around a cylinder. Some means, therefore, had to be found which would enable a picture to be transmitted directly from a flat surface. This can be done by moving the light beam instead of the picture. By rotating a suitably-designed and arranged series of prisms between a fixed light source, and a fixed flat-surface picture, the beam of light is made to traverse the picture from side to side, moving slowly across it as it does so, so that ultimately the entire surface is covered.

This, very roughly, is the operating principle of television apparatus, but only as applied to the transmission of a single picture or image.

From the transmission of a single picture from a flat surface to television is a far cry, however; and, to understand something of the tremendous obstacles to be overcome, let us consider the cinematograph. When witnessing a movie performance, we think we see a smoothly flowing animated scene. Actually, we are looking at 16 separate and distinct pictures every second, but, owing to the persistence of human vision, we do not receive this impression from the sense of sight.

The one and only similarity between the movies and television is that, in both cases, the scenes are projected upon a screen. In order to make television a success, it is necessary to transmit and receive something like 16 complete pictures per second, in order to give the witnesses an impression of lifelike movement.

THE BAIRD SYSTEM

The most successful inventor of apparatus for the achievement of television is John L. Baird, a young Scottish engineer. He is 35 years of age, and the son of a Presbyterian minister at present living in Edinburgh. After studying at the Royal Technical College, Glasgow, Mr. Baird "served his time" as an engineer at a motor works near Glasgow; after which, in 1912, he commenced his experiments in television. Faced with many difficulties, he persevered until, in 1923, he succeeded for the first time in sending shadows which were flickering and coarse in outline, but unmistakable. About a year later he was successful in transmitting the image of objects by light reflected from them; and so he progressed until, early in this year, he

was able to transmit a recognizable image of a human face, and demonstrated his invention before the Royal Institute, one of England's leading scientific societies.

The apparatus used by Mr. Baird to attain these results may be described as follows:

At the transmitting end, a battery of powerful lights shine upon the scene to be transmitted. Light reflected from this scene is collected by means of a lens, in much the same fashion as a camera lens collects the light reflected from a scene to be photographed. In the television transmitter, however, instead of a sensitive photographic plate, as in a camera, the reflected light is focused upon a light-sensitive cell.

Between the focusing lens and the cell, however, there are interposed two rapidly revolving discs. One of these discs has a number of lenses mounted upon its face in spiral fashion, as shown in Fig. 1. The function of these lenses is to cause the image of the transmitted scene to sweep across the light-sensitive cell in such a manner that the image is divided into fine parallel lines. The rotation of the disc gives the horizontal motion (*i.e.*, draws the lines), while the movement into focus of the next lens (set a

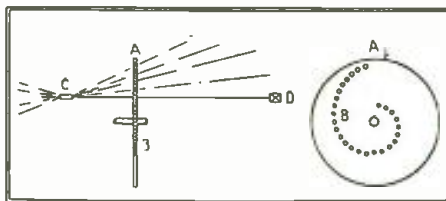

Fig. 1. The action of the Baird television transmitter: A is a rotating disc carrying spirally-arranged lenses. B, through which shines light reflected from scene, and collected by lens C. Movement of disc causes light beam to traverse light-sensitive cell D in two directions, horizontal and vertical.

trifle nearer the center of the discs) gives the necessary vertical motion to ensure that the lines do not over-lap. Reference to Fig. 1 will assist the reader to understand the action.

In this manner the entire image is flashed across the light-sensitive cell in the space of one-tenth of a second. The light reflected from the high lights of the scene to be transmitted is, of course, very bright, while that reflected from the dim shadows of the scene is very dim. The light-sensitive cell transforms these light variations into electric-cur-

rent variations, which are then amplified and transmitted over the circuit to the distant receiver.

SPEEDING UP THE TRANSMITTER

The second disc referred to above is a serrated one, and its purpose is simply to interrupt the light at high frequency. By this means Mr. Baird found it possible to eliminate the inertia of selenium, and cause it to respond at a speed great enough to enable him to transmit a sufficiently large number, of complete pictures per second, to give to the observer at the receiving station the effect of a smoothly-animated scene.

Another advantage of interrupting the source of light is that the output of the light-sensitive cell takes the form of a unidirectional current, interrupted at high frequency, instead of a fluctuating D.C. as would otherwise be the case. A steady D.C. cannot be amplified by ordinary vacuum-tube amplifiers, whereas interrupted D.C. can. As the output current of a light-sensitive cell is extremely feeble, such amplification is necessary before transmission over a wire or wireless circuit can be accomplished successfully.

At the receiving end of the circuit Mr. Baird uses apparatus which, though similar in essentials to that used at the transmitting end, has been reduced to the simplest possible form. There is a source of light and a ground glass screen, and between the two rotate discs similar to those used at the sending station. The incoming current impulses are caused to vary the intensity, or brilliancy, of the light source, in accordance with the strong and weak currents delivered by the light-sensitive cell at the transmitter.

The rotating-lens disc then breaks up the beam of light and throws it on the screen as a complete moving picture. The discs at the transmitting and receiving stations are in each case driven by electric motors, and in order to achieve success, it is necessary that the motors at all receiving stations shall be in exact synchronism with the transmitting motor. This is accomplished in the Baird system by transmitting, in addition to the picture impulses, a low-frequency alternating current, by means of which all motors are kept in step.

AN ACTUAL DEMONSTRATION

Having dealt so far with the nature and general problems of television, and outlined (Continued on page 280)



Capt. Hutchinson and Mr. Baird discussing part of the latter's television apparatus.

Radio News of the Month Illustrated

By GEORGE WALL

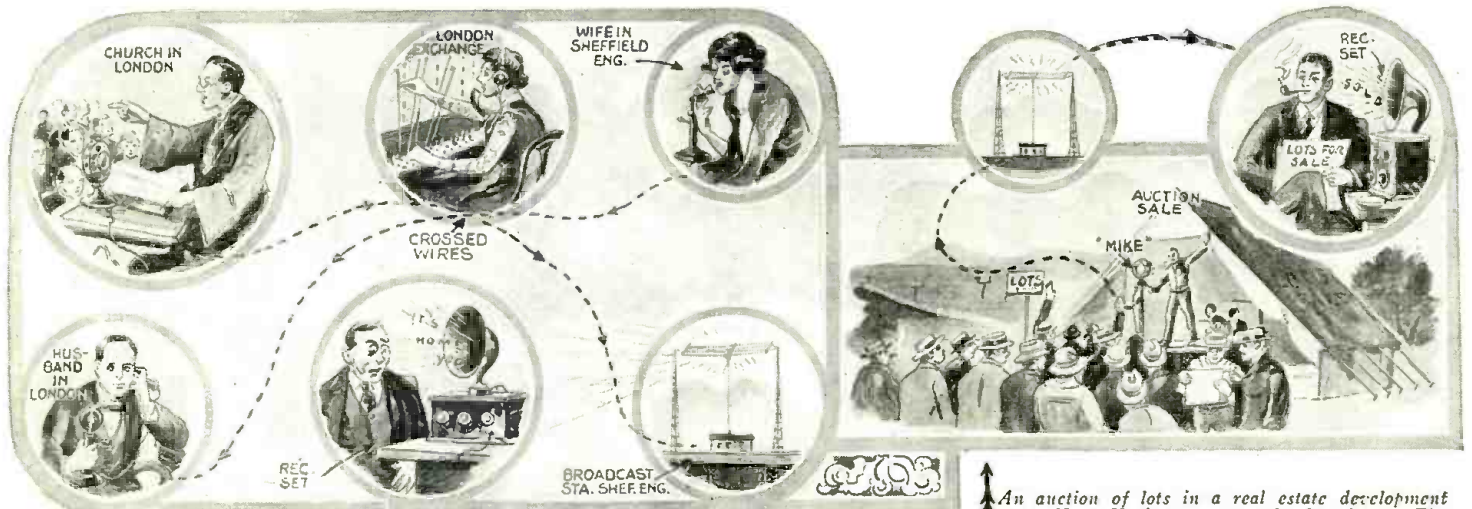

Adapting from Kipling, "Though Love is blind, the world at large has ears." British broadcast listeners, through the crossing of land-lines, were recently favored with a personal conversation between a husband and a wife, who were using the long-distance telephone, instead of the expected sermon.

An auction of lots in a real estate development near New York was recently broadcast. The listening public was thus enabled to hear, not only the auctioneer's eloquence, but the bidding, and to draw their own conclusions. In addition, the sender of a sealed bid could hear it read off, without the necessity of attendance.



The portable radio set is now the companion, not only of the recreation seeker, but of the worker. Farmers in the region of Pittsburgh provide their families and hired help with entertainment as they work in the fields; the set being readily transported in the manner shown.



Radio plays are being produced in increasing numbers, as their technique is being perfected. Until television sets become common, their presentation is, of course, only to the ear.



The magnitude of army signalling operations is not generally appreciated by the public; it is necessary to have more wave-lengths for the sending instruments than there are in the entire broadcast band. Over 1,000 transmitters and as many receivers are necessary for a field army, with at least 200 non-interfering wave-lengths; all operating, not under laboratory, but under outdoor conditions. During the summer hundreds of radio amateurs have been receiving instructions in army field camps, as explained in the August RADIO NEWS.

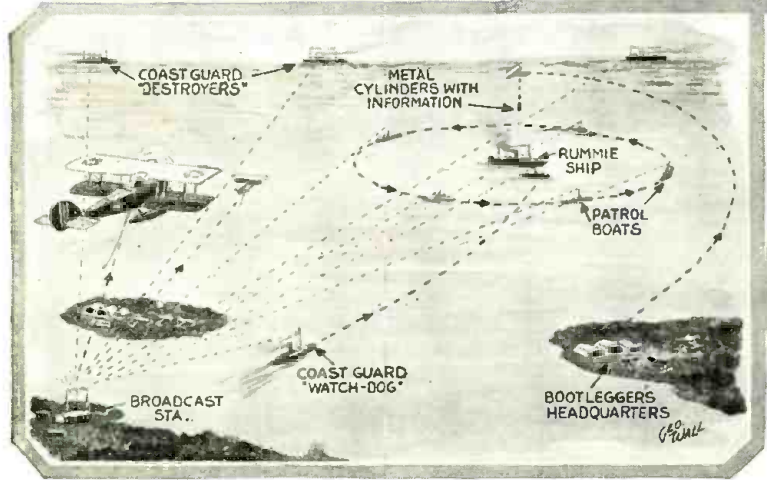

Above, some of the stunts in the war between the Coast Guard and rum runners along the Atlantic Coast. The latter used air-planes for carrying information, dropped to their feet. The Coast Guard, however, uses the even more effective and instantaneous radio phone, by which the encircling cordon of patrol boats acts as a unit.

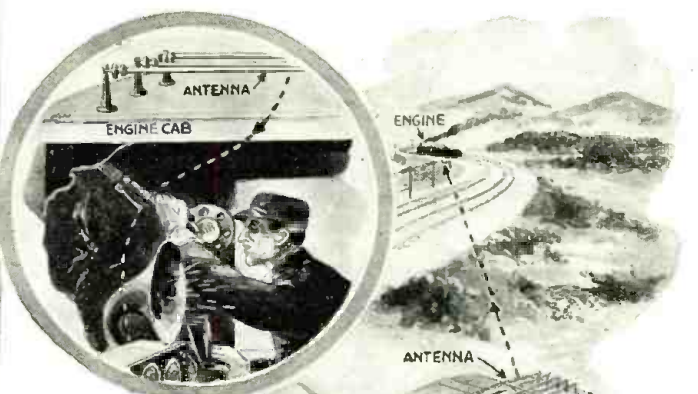

Right, train-telephone communication effected on the New York Central. Engine and caboose of a freight train are in constant communication, even at four miles and in spite of thunderstorms. A wave-length of 115 meters was employed for this work, with 3-tube transmitters and 4-tube receivers. Antennae were mounted on the roofs of engine cab and caboose.

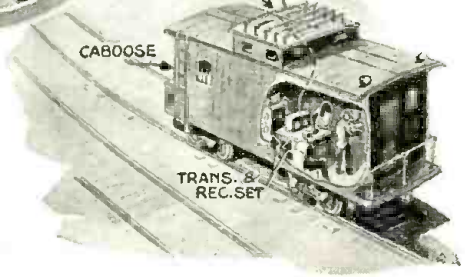

What Price Salesmanship?

By N. B. PLATT

A true story of a farmer who spent many grievous hours over his radio because the "salesman" who sold him the set did not know his business—or didn't care. Such radio "experts" should mend their ways or seek a more fitting profession.

HAS it ever been your experience to rush into a radio shop, yelp at the salesman, "Slip us a 17-plate condenser quick!" and have him shove you over the counter a fixed condenser with these sweet words, "Here's one with the same capacity, won't that do?" That happened to me the other day—honestly it did.

Of course I refrained from murdering the so-called salesman, but I don't think that there should be a single court in this fair land that would not have commended my action as justifiable homicide. To my mind there is about as much excuse for an occurrence of that kind as there is for an armless man trying to swim across the Atlantic Ocean. A bone-head play like that is easily rectified by an old-timer in the radio game; but think of the loss of time, money and confidence to a newcomer.

There is an enormous number of radio fans, who look upon the men in the radio stores as entirely competent to answer any of their radio questions; but what chance has a raw beginner against anything like that? About as much as you or I would have beating Tilden at tennis playing left-handed. And yet let me tell you a little story that is as true as a straight line.

Recently I was up in Connecticut doing a little expert loafing around a camp that was carefully parked beside a bronk, where the trout were just begging to be taken out and tossed into a frying pan. One evening after supper I was sitting in front of my fire listening to Vincent Lopez doing his stuff *via* one grand little portable set, at peace with the entire universe. Then as the movies have it in their titles, came a hail—

"Hey, there, young fellow, what kind of a radio you got?"

I flopped over and took a look at my visitor. You've seen farmers in the funny papers, haven't you? Well, this specimen must have been the fellow who posed for the funniest of them all. You know, funny whiskers, that bashful-like played around his chin; old straw hat, rubber boots—all the trimmings. However, the old fellow seemed like a good scout and I asked him to come over to the fire and pick up an earful of jazz.

He sure ate up that music and, when Vincent had signed off, he started in asking me all manner of questions about my set, which by the way had done itself noble that evening before company. Then came the sad, sad story. He had gone into the nearest town (which I will call Podunk, because it wasn't) and gathered unto himself a radio outfit for the long winter evenings that were coming. He had paid out somewhere in the neighborhood of two hundred and fifty smackers and what did he have? He had a real nice radio layout, the only thing wrong being that it wouldn't perk.

I inquired if the firm from whom he had purchased the set had installed it for him. The answer was yes. They had put up the antenna, connected all the batteries, and told him about putting the ground on. The reason the young installer had not completed the job was that it was five o'clock and therefore quitting time.

"How did he tell you to attach the ground to the set?" I asked Mr. Johnson.

"He left me a thing he called a ground clamp and told me to connect that to the set with a wire," was the answer.

"Do you have running water in your house, Mr. Johnson?" I continued.



"Do you know what I did, young fellow? Well, I connected that ground clamp to the set all right, but do you know where I put the clamp? Right on the mantel shelf in the parlor! No wonder we couldn't hear anything with no ground on the set."

"Gosh amighty, what do you want to know that for? Of course, we don't have no water but what's in the well, and you have to pump that out," he replied.

Then I tried to explain to him the theory of grounds in one syllable words, but in the middle of it I was interrupted by a few choice farmer curses. After he got the worst of them off his chest, Mr. Johnson apparently saw a great joke, for he laughed as hard as he had cursed.

"Do you know what I did, young fellow? Well, I connected that ground clamp to the set all right, but do you know where I put the clamp? Right on the mantel shelf in the parlor! No wonder we couldn't hear anything with no ground on the set! Ha, ha, ha!"

He said good-night to me a few minutes later still chuckling and after dousing the fire, as all good woodsmen should, I crawled in between the blankets. The next afternoon when I got back from whipping the stream—and without any success incidentally—I found Mr. Johnson parked in front of my tent waiting for me.

"Hello there," I called, "how is your set working now?"

"Well, son, she ain't working like the fellow in the store said she would."

"What do you think is wrong now?" I asked.

"I dunno. Say, why don't you come over to my house for supper, if you can put up with what we've got, and take a look at that radio of mine?"

Having had experience with "if-you-can-put-up-with-what-we've-got" invitations to country meals, I accepted Mr. Johnson's invite and in a little while we were crossing over as pretty a meadow as I've ever laid my eyes on. When we came within sight of the house I asked Mr. Johnson where his antenna was, as I could see none.

"Why we got that in the house, so as the lightning wouldn't hit it."

I didn't say anything, but, oh, boy, what I was thinking!

After I met his wife, Mr. Johnson took me into the front parlor and there, Brother Radio Fans, was one grand and glorious example of how NOT to install a radio receiver. Mind you, all this I'm telling you is gospel truth.

For an antenna there was about fifteen feet of copper tape strung from one corner of the room to a picture, where the rest of the length was hanging bunched together instead of being cut off. What a fine chance Johnson had of getting any music when the nearest station was about fifty miles away! And don't forget for a minute that this was the outfit that a radio dealer had "installed."

During supper I told him that this lightning danger was all the bunk, if his antenna was properly equipped with a lightning arrester. As it was a beautiful clear evening, I suggested that we rig up a temporary antenna outside and see what we could pull in. That suited him down to the ground and between us we managed to have an antenna and ground arrangement, that was crude, but, boy, she was efficient.

Then we went back to the set. I happened to look at the connections, as somehow or other I did not trust that radio dealer any more. And then the jolt I was handed! The "B" batteries, instead of being connected in series, were in parallel; to the binding post labelled "Ground" were the ground wire and both tips of the loud speaker leads. There were other little incidentals wrong here and there, but why go into any more detail? You can see just as well as I did how many more sets that radio dealer should install.

If there is anything I admire it is a salesman who can go out in the face of tremendous odds and sell some stuff to people who do not particularly want it. It takes nerve to do that, but to my way of thinking it takes

(Continued on page 258)

Radio Equipment of the Byrd Polar Flight

At the left is shown the radio room of the steamer "Chantier," with Chief Radio Operator Grenlie (seated), and Second Operator James. The "Chantier" carried a 1-kw. quenched-spark transmitter and navy receiver, as well as a 500-watt transmitter, 13-, 20- and 40-meter, and a receiver for the 10-to-100-meter band.

© Herbert Photos.

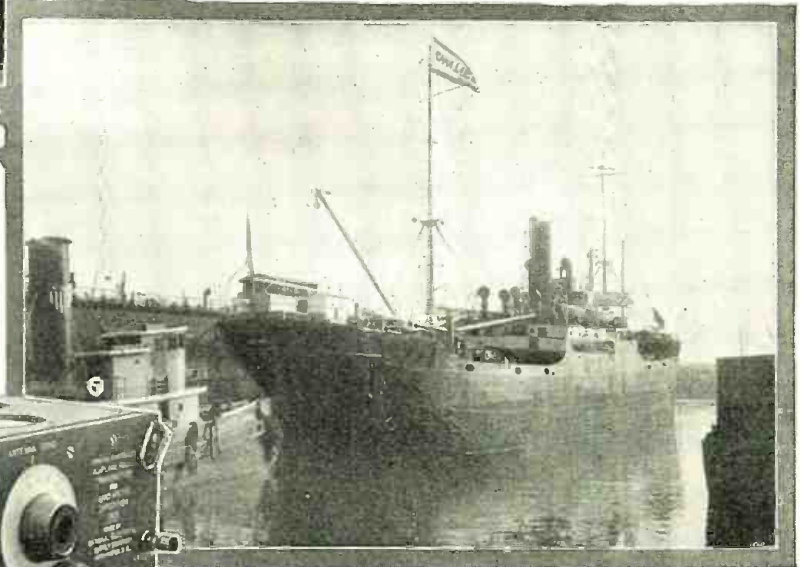

The steamer "Chantier" (at right) carried the Byrd expedition to Spitzbergen, the nearest land accessible as a base for the polar flight, and maintained radio communication with the airplane "Josephine Ford" on its successful expedition to the pole. It also kept in touch with the U. S. Navy, and amateurs in the United States, as told in the August issue of RADIO NEWS.

© Herbert Photos.

The set shown in the center of the page is the transmitter of the "Josephine Ford," which sent out the first radio signals from the North Pole. Its message was picked up by the "Chantier" and relayed by the powerful set shown at the lower right.

© Wide World Photos.

Below, the "Josephine Ford" in trial flight. Its wing-span is 63 feet 4 inches.

© Herbert Photos.

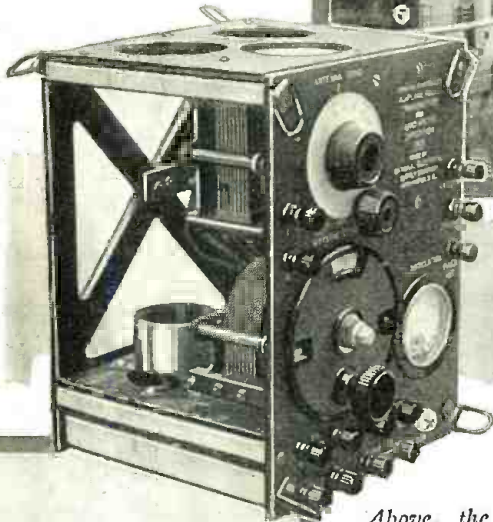

Above, the "Chantier." © Herbert Photos. Below, her short-wave transmitter.

© Wide World Photos.

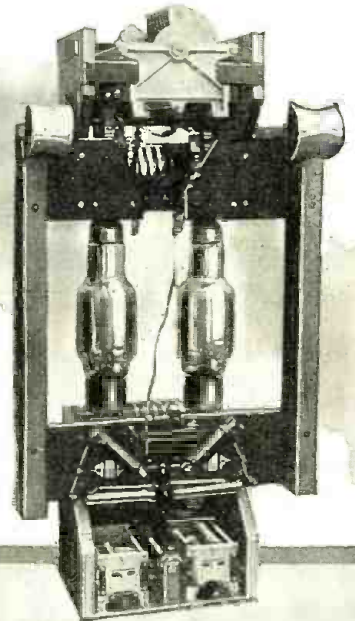

Above, the transmitting set carried on the Fokker monoplane below which flew to the North Pole with Commander Byrd, and which announced the discovery at the moment the position was determined, with none of the delays which attended the reports from all previous explorers.

© Herbert Photos.



Radio—Here, There and Everywhere

This baby grand piano is an easy one to tune, and produces very pleasing melody. A home-constructed six-tube receiver, of the T. R. F. type, has been incorporated within the body. The open cover of the piano aids in distributing the sound waves from the cone speaker, which is plainly visible. © Herbert Photos.

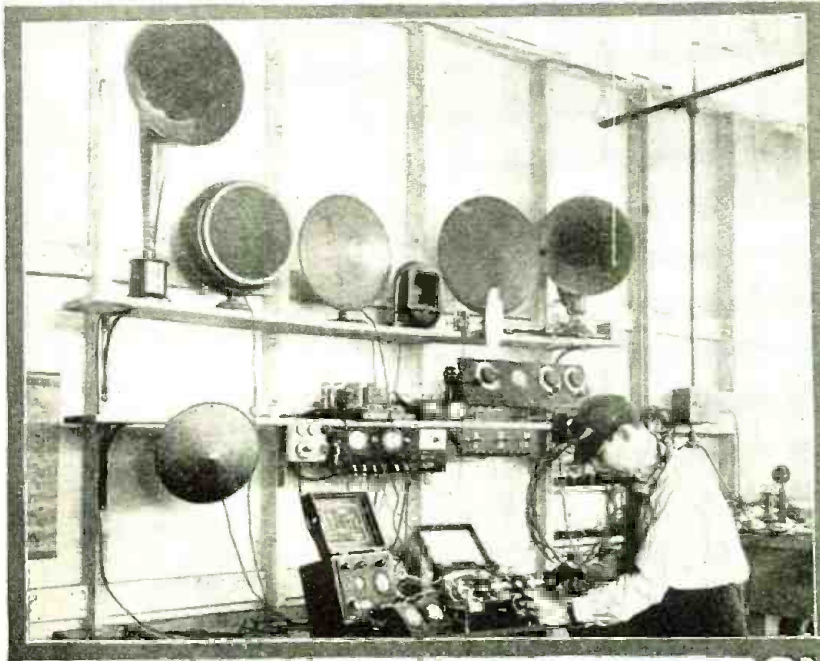

Work or pleasure? A radio engineer pursuing his profession and his hobby at once. Like many others, Mr. Harold Herdert, shown above, is working on the problem of improved receivers with lower costs of construction. © Herbert Photos.



The splendid interior shown at the right is that of a residence erected by a contractor in Oakland, Calif., who recently exhibited it to the public. Radio is "built-in," the speaker being behind the grill in the balcony. All rooms have plug connections for the speakers.

Lower left, the "Tubeless Anti-Dry" set. No diagrams of the hook-up can be furnished by this magazine, but it is said that the damping effect is pronounced.

© Herbert Photos.



On the edge of the world: Albert H. Kott-nauer tuning in DX, on top of Half Dome, a precipitous peak in Yosemite National Park.

© Wide World Photos.



WRNY Celebrates Its First Birthday

By CHARLES D. ISAACSON

YES, thank you, WRNY is one year old and doing very nicely. WRNY had its birthday party and there were gay doings; you should have been there. In all probability you were—over the radio. I wonder if any of my readers stayed all through it. I myself was exhausted when it was over, but I danced to the last lingering dance, about two in the morning.

It was a great day: June the 12th, and WRNY just one year old. Grant Mitchell made the cleverest speech of the day. He came over from his successful play, "One of the Family," in which he is starring, to join the theatrical unit; there being units from every walk of life to pay respect to the station. Grant brought a present: it was a small child in a bathtub, and with it was a birthday card. Grant said he had a hard time procuring the right kind of card, because the card-seller did not know what sex a radio station is supposed to be. Grant declared that WRNY is a lusty baby in any event, and that probably the reason is that it is out in the air all the time!

Dr. Lee de Forest made the most complimentary speech. The father of radio broadcasting was present at the very birth of WRNY and has watched it through these trying months of its infancy. So he spoke with a great deal of godfatherly pride.

We began with a group of smart youngsters from the National Stage Children's Association, who had previously entertained the President at the White House. Then some of our leading authorities in the women's hour: Ruth Come on Fashion, Mrs. Mary Fanton Roberts on Arts and Decoration, Mrs. Rose V. S. Berry on Painting and Sculpture, and so on down the long list—each took two or three minutes to administer just a capsule of thought and entertainment.

By noon we felt sufficiently educated, and a whole hour of the wildest, maddest, merriest, bluest and reddest popular and jazz music rent the air. Dr. de Forest was listening and I am wondering what he thought of his responsibility as the father of broadcasting. In any event the young folks, who adore this phase of WRNY's entertainment, sent in dozens of added requests. After luncheon, we returned for a matinee, in which a dozen of WRNY's finest ensembles came in for a fifteen-minute show. Talk about your continuous performances! Now it was grand opera; now it was an instrumental trio; now it was a real concert imported right from Carnegie Hall; now a little army of violinists playing in unison.

At twilight, the members of the Radio Theatre Players, having finished their own Saturday matinees, dashed over to WRNY with a lift in the form of a play "The Surprise." Olive Wyndham was the guest star, and James Durkin, a well-known director, was another guest. Well, from then on, it was a case of one celebrity after another.

(Continued on page 297)



MARIE TIFFANY
of the Metropolitan Opera Company, who sang for us lately over WRNY.



MICHEL BARROY
Russian baritone, who has appeared with the Follies, is a frequent feature at WRNY.



VIRGINIA HOWELL
Of "Alias the Deacon," whose charming Southern readings at WRNY are always welcome.



John Henry Titus
The nonagenarian author of "The Face on the Bar-room Floor," recited it for us at WRNY.



OLIVE WYNDHAM
Now starring in South Africa, paid WRNY a visit the night before she sailed.



Wellington Cross
Of "No, No, Nanette," is now almost a permanent member of WRNY's staff of announcers.



Helen Wasserman
Of the Geon ensemble—not Irene Bordoni, as you may have thought from her vivacity.



David Putterman
Youngest of the cantors. You may have heard his fine voice in records as well as over WRNY.

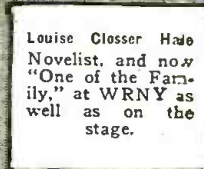

Louise Closser Hale
Novelist, and now "One of the Family," at WRNY as well as on the stage.



Sir Gilbert Parker
Canada's greatest novelist, was one of WRNY'S many celebrated visitors of late.

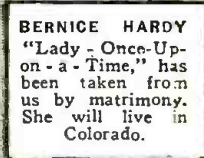

BERNICE HARDY
"Lady - Once-Upon - a - Time," has been taken from us by matrimony. She will live in Colorado.



Beniamino Fiesio
Baritone, is one of the popular soloists who make so delightful the Edison Hour at WRNY.

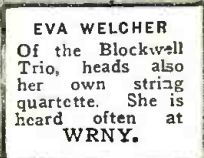

EVA WELCHER
Of the Blockwell Trio, heads also her own string quartette. She is heard often at WRNY.



ISABELLE AUSTIN
Used to be of "Roxy's Gang," but has now one of her own at WRNY.

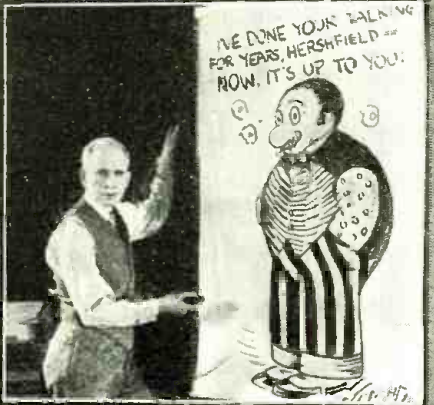

HARRY HERSHFELD
Cartoonist, is shown here with his famous creation, Abie Kabibble. They entertained you recently from WRNY.

"Echoing Silence"

By GEORGE B. LUDLUM

"STATION KOA, General Electric, Denver, Colorado. The Kimball Sisters will next entertain you with a medley of old-fashioned airs." Faint but beautiful strains of music filled the air—such as it had never been my good fortune to hear before from any radio receiver. Startled and curious, I turned my eyes and ears towards the row of weather-beaten houses before which I chanced to be passing.

Whenever possible it is my nightly custom, in the search for incidents and local atmosphere for the series of stories I have been writing, to wander through the less-frequented residential streets in whatever city I may be stopping. It had been my intention this day to reach Springfield before evening, spend a few days there, and then drive through to my chum's experimental farm to look over some of his latest results in fruit culture. Several miles out of a little rural town, however, an unhappy combination of hot weather, dust, and forgetfulness in filling my radiator had conspired to interrupt the smooth working of my motor, and by the time I reached the town's garage and repair shop I was humorously limping along on two cylinders with my radiator much resembling a super-heated steam engine. Needless to say, I was somewhat put out when informed by the garage mechanic that the punishment I had given my motor would necessitate considerable overhauling, and that he could not possibly finish the repairs before noon of the next day.

After securing a room at the town's only, and rather run-down, hotel, I washed up, left my bag, and managed to obtain a fair meal at the combination lunch counter, pool-room and auto bus station across the street. Then, having nothing to do and finding little to interest me in the idle click from the few occupied pool tables, where but a handful of nondescript players were seeking their evening's amusement, I decided to while away the hour or so before dark with a stroll down the main street to where the dwellings blended into the farms of the surrounding country. A few minutes of indolent rambling brought me to the last block

of scattering houses with the open fields beyond; and I was just on the point of turning about and seeking the other extremity of the town when my ear was struck with the broadcast announcer's voice from a station, many miles away, in the words which open this narration.

And, yet, to describe it as having struck my ear does not begin to cover the eerie effect it produced upon me. The voice and the following music seemed to place its origin in no definite location but rose from the ground I stood upon and descended from the sky above me, completely baffling my aural sense of direction. There being no houses on the opposite side of the street, common sense told me that the sound came from one of the houses before which I stood; but from which one I could no more say than I could have told you the name of the individual residents. Mystified and puzzled, I glanced from one house to the other. Of the half-dozen dwellings which stood between the last street crossing and the open country there were four above which aeries were suspended, and from any one of which that super-refined radio music might have been coming. By way of experiment, I decided to see if distance would lend me any assistance in determining the source of my delight; and to that end I walked with impatient steps the hundred yards or so still remaining to the edge of the town, then turned and made my way slowly back along the sidewalk, endeavoring meanwhile to concentrate upon the point where the sound of the music reached its greatest intensity in my hearing. At my point of turning at the sidewalk's end the music was heard but



faintly, but it increased in volume as I returned.

Just as I passed the first house on my backward path the music ceased, so that I stopped suddenly in my tracks with the prayer that my search might not thus terminate so hastily. It was with the greatest relief, then, that I heard the announcer's voice followed by the first rounded chords of a piano number, Chopin's "Nocturne," if I remember correctly. But such piano music as it was! Every note and dissonant beat throbbed through my sense of hearing as I had never heard the sound of a piano before; not even when seated before one of the masters in crowded Symphony Hall.

Desire to solve this most agreeable puzzle quickened my foot-steps; and as I passed the second house the intensity of sound made me half expectant of seeing the colorful piano and its player upon the vine-covered, although dilapidated, front porch. All that I got from my curious stare into the darkened coolness of the porch was a half-hearted return look from an old, gray-bearded patriarch who, with his wife beside him, leaned forward from his rocker with his white shirt sleeves upon the porch railing. His evident interest was centered upon that same illusive music I was seeking; and which, judging from the turn of their heads, was to their knowledge emanating from one of the other homes towards which I was walking.

I did not presume to question them, but continued on my way with the hope and expectation of at least learning which house contained the radio receiver capable of reproducing such distant broadcasts with such happy fidelity. But from there on, although I passed three houses, the first and third of which boasted of antennae, there was no appreciable diminution of sound and it was not until I reached the last home at the street intersection that the music became fainter, although still remarkably clear.

The only result of my search was the knowledge that the radio receiver with such

(Continued on page 299)



The Radio Beginner

Audio Amplification for the Beginner

By A. P. PECK

IT seems to be a fact that the average radio fan, who has constructed a single-tube or a crystal-detector receiver, is reluctant to attempt the construction of an amplifier to use in connection with his set; inasmuch as he believes that such work is far too difficult for him to attempt. There are hundreds, if not thousands of radio enthusiasts throughout the country, who content themselves with small sets, but who would derive far greater enjoyment from radio if they had a good amplifier. Not only does it render DX (distant) signals stronger and more easily heard, but it gives loud speaker reception on all of the locals, and many stations at a moderate distance away. There is nothing to be afraid of; if you have gone through the work of building a set, you are qualified to start making an amplifier. You will probably find it less difficult than the assembly of the receiving set proper.

Two types of amplification are used in radio receiving sets; one called radio-frequency amplification and the other audio-frequency amplification. The former is of value in making sets more sensitive; it is used between the detector either of the crystal type or a vacuum tube, and the antenna circuit. We will not discuss this now, but reserve it for the near future. At present we will concern ourselves only with audio-frequency amplification, which is used between the detector tube and the reproducing unit, whether headphones or loud speaker.

A MECHANICAL ANALOGY

An audio-frequency amplifier may be likened to a magnifying glass; as the latter makes it possible to see objects that otherwise are invisible, or indistinct, so does the audio-frequency amplifier allow us to hear "signals," music and voice, that otherwise could not be heard at all. It is not possible here to explain simply and in detail,

how an amplifier works from an electrical standpoint. However, we can cite a mechanical analogy that will probably aid the beginner.

In Fig. 1 we have a water supply under pressure, which may be likened to the "output" of the detector. This water supply acts upon a specially-constructed valve, which releases a second water supply at a higher

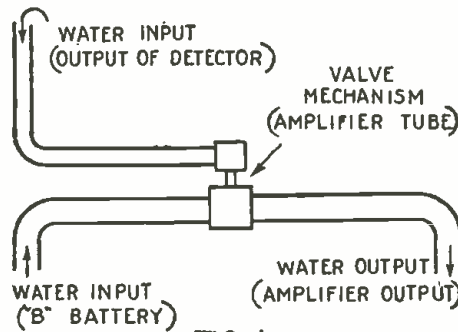

FIG 1
A water analogy of the operation of an audio-frequency amplifier. The valve, operated by the water input, controls the flow of water in the large pipe.

pressure than the former one. The valve corresponds to the vacuum tube in an amplifier, and the pressure may be likened to the voltage in the amplifier circuit. Since the second water supply is at a higher pressure, it will deliver a greater volume of water. So also, the amplifier of the audio-frequency type delivers a greater volume of sound than the initial quantity put into it.

Let us here explain two words that may be a little confusing to the beginner, but really should not be. The "input" is the point in a circuit where the signals are fed in. The "output" is where a current emerges that has the original form but is am-

plified, as in a radio-frequency amplifying circuit; or is reproduced in the form of an entirely separate and distinct current of higher value, as is the case with the detector and the audio-frequency amplifier.

THREE TYPES OF AMPLIFIERS

There are three principle types of audio-frequency amplifiers, all of which have their good and bad features; and practically every advanced radio fan has his pet form of amplification. These three general types are called, transformer-coupled, resistance-coupled, and choke-coil—(or impedance-coupled) amplifiers.

It has been frequently asserted that resistance- and choke-coil-coupled amplifiers will give very pure and natural reproduction of voice and music. This is undoubtedly true, and there is little or no distortion in either of these two types. However, a well-built and properly-arranged amplifier, using transformers, will be found to give very satisfactory results for all-around use, and to be more economical in operation.

The average resistance- or choke-coil-coupled amplifier, employing three vacuum tubes, will give just about the same volume of signal strength as a two-tube transformer-coupled amplifier. If transformers of high quality are selected, the voice reproduction from such a two-stage amplifier will be just about as good as can be desired. True, slightly better tone values on some musical notes may be obtained from a resistance- or choke-coil-coupled amplifier, but for all-around use it is hard to beat a transformer-coupled unit. To obtain satisfaction from your amplifier, and avoid disappointments, the only safe way is to purchase standard, nationally-advertised instruments of well-known makers, which will assure you of good quality in reproduction.

Furthermore, as mentioned above, only two tubes are required in a standard transformer-coupled amplifier, and, therefore, the battery up-keep is less. Also, the latter-mentioned type of unit will operate satisfactorily on only 90 volts of "B" battery, whereas a resistance- or choke-coil-coupled amplifier requires at least 135 volts for best results. Inasmuch as so many articles have been recently published detailing resistance- and choke-coil-coupled amplifiers, we are merely going to mention these two instruments herein and confine our paragraphs to the description of transformer-coupled amplifiers.

CAUSES OF DISTORTION

Distortion was formerly one of the greatest bugbears of amplification in radio receiving sets. Improperly-designed amplifiers gave rise to some of the most peculiar and weird results. Voice and music were changed from their natural pitches, becoming almost totally unrecognizable. This obviously undesirable characteristic has been eliminated to a very great extent by the proper design of modern transformers; and if you buy good instruments and arrange them properly, as described later, you need

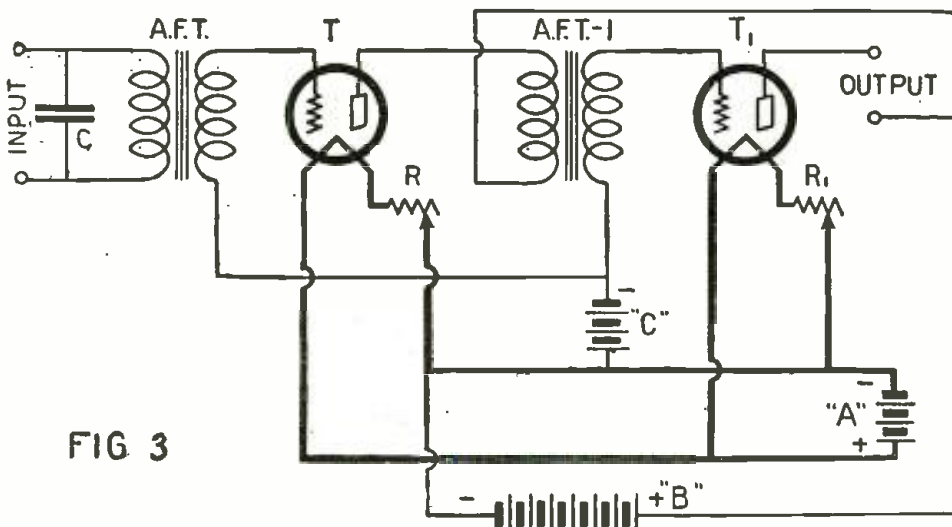

FIG 3

Circuit diagram of a conventional two-stage transformer-coupled audio-frequency amplifier. The minus pole of a "C" battery connects to the grids of the two tubes and prevents them from being overloaded.

not fear any undue amount of distortion.

With the present-day standardization of vacuum tubes, the possibility that some distortion may be due to the tubes may be practically eliminated from consideration. The tubes on the market today are almost universally good and can be depended upon. An article appearing in the August, 1926, issue of RADIO NEWS gives tube information in minute detail.

Because of the standardization of vacuum tubes it is possible to simplify the construction of an audio-frequency amplifier, to a very great extent, by the substitution of fixed resistances for the usual variable rheostat. This, however, is true only of amplifier-filament circuits, and must not be applied to detector-filament circuits. These resistances are connected in the circuit as shown in Figs. 2 and 3, as indicated by R and R-1; and serve as controllers to regulate the "A" battery voltage.

There is nothing more to be said about the "A" battery, "B" battery and "B" battery

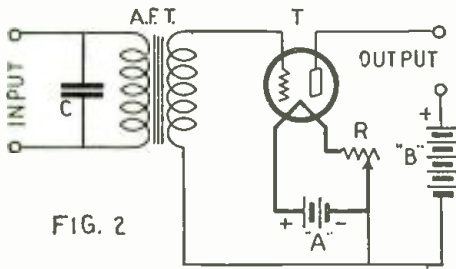

FIG. 2

Circuit diagram of a single-stage transformer coupled audio-frequency amplifier. No "C" battery is used; the grid return connects to the negative terminal of the "A" battery.

eliminator, than has been told in the April and May issues of RADIO NEWS in this department. Here these subjects were fully discussed; and the prospective audio-frequency amplifier constructor should read over these articles before proceeding further.

THE "C" BATTERY

In some receiving sets a "C" battery, or "grid" battery, indicated by "C" in Fig. 3, is used. Its electrical functioning will not be described here, because of the technical explanations that would be needed; but it is sufficient to say that a "C" battery should always be used with a two-stage audio amplifier, and will occasionally be found of assistance with a one-stage unit. It is always connected so that its negative side leads to the grid of the tube, usually through the secondary of the audio-frequency amplifying transformer. The positive side of the battery connects directly to the negative side

of the "A" battery. It is a wise idea to get a variable, or tapped, "C" battery, unless you are quite sure what voltage will operate your amplifier unit best.

For all-around use with standard tubes of the UX 201-A type and with 90 volts of "B" battery potential, a "C" battery with a maximum voltage of 4½ will be quite satisfactory. This should be obtained with a 3-volt tap, so that a choice of two different voltages may be had. Sometimes it is found desirable to connect the secondary of the second audio-frequency amplifying transformer to the 4½-volt tap, and the secondary of the first transformer to the 3-volt tap. Try various arrangements until the signals are clearest and of the greatest strength.

This "C" battery is of particular value; if more than 90 volts is used for the "B" battery. If the "B" battery voltage is increased, that of the "C" battery should also be increased. With 135 volts of "B" battery, a 7- or 9-volt "C" battery will be found very necessary. The same is true if a "B" eliminator is used. The only way to determine exactly what voltage will be best for the "C" battery, in connection with the particular tubes and "B" battery you use, is to try various values until the best possible results are obtained.

CONSTRUCTION OF AN AMPLIFIER

If you own a single-tube or a crystal-detector set and want only to get an increase in volume, to enable you to bring in DX stations on the headphones so that they will be clearly understandable, a one-stage amplifier, the circuit diagram of which is given in Fig. 2, will be found quite satisfactory. This requires only an additional transformer, AFT, a vacuum tube, T, and some "B" batteries in addition to those already used with your detector tube. In case your present receiving set has fixed condensers connected across it, the condenser labeled "C" in Fig. 2, will not be necessary.

The circuit of Fig. 2 is designed for the use of a crystal receiver. If the receiving set you now have is of the single-tube type, the same "A" battery may be used for the filament of the amplifier. The additional "B" batteries, two 22½- or one 45-volt unit, may be connected directly to the positive terminal of the present "B" battery. Connect the positive of the battery in use to the negative of the additional unit; and connect the positive part of this battery to the output binding post, as indicated in Fig. 2.

With a vacuum-tube or one-stage amplifier, you will have little or no trouble with distortion. It is only when you venture into the class of two-stage amplifiers, such as in Fig. 3, that trouble is encountered.

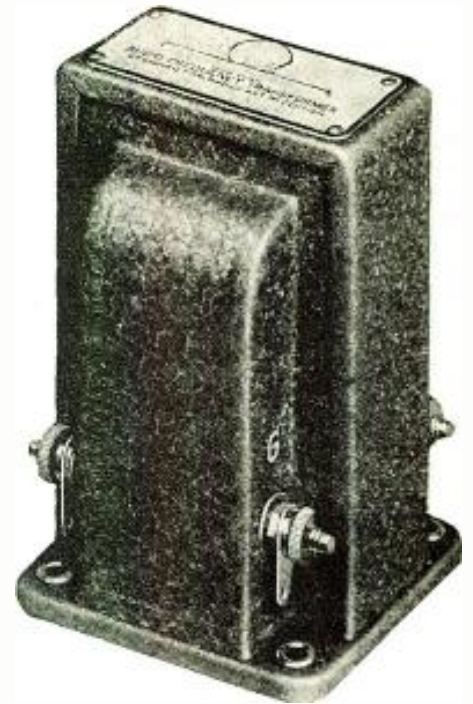

A typical A.F. amplifying transformer of the newer type. Photo by courtesy of All-American Radio Corp.

This amplifier will make it possible to procure ample voltage to operate a loud speaker on a good many different stations. The same things, said above, regarding the "A" and "B" batteries used in connection with the single-stage amplifier, apply to this two-stage amplifier. However, the "B" battery should be at least 90 volts; whereas only 67½ volts are required for the single-stage amplifier.

FUNDAMENTAL PRINCIPLES

There are certain fundamental principles underlying the design and construction of audio-frequency amplifiers, which must be adhered to, if the best results are to be obtained. The most important will be described. First and foremost, keep the leads between the amplifying transformers and the grid and plate binding posts on the sockets as short as possible. Never run these leads parallel with each other for any distance. To do so may cause the amplifier to squeal in an undesirable manner, and give poor results in other ways. By proper arrangement these leads can easily be kept very short and any such trouble will be avoided. On the contrary, however, the filament con-

(Continued on page 283)

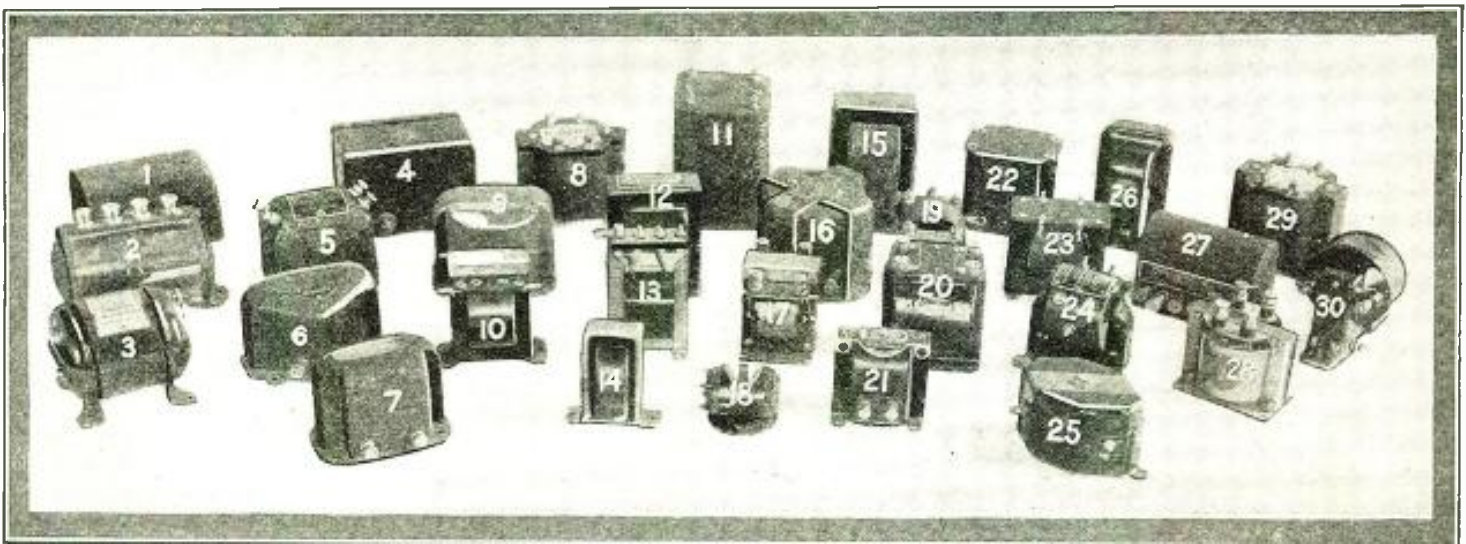

A group of the commercially-manufactured A.F. amplifier transformers which are being studied in the RADIO NEWS laboratories: 1, Como (push-pull); 2, General Radio (English); 3, Karas; 4, Jefferson; 5, Modern Symphony; 6, Precise; 7, Perry; 8, Wagner; 9, Acme; 10, Quality; 11, Marlefer; 12, Thordarson; 14, Thompson-Levering; 16, Erla; 17, Supertran; 18, Hedgehog; 20, Samson; 21, Dongan; 22, Amertran; 23, Kellogg; 24, All-American; 25, Bremer-Tully; 26, General Radio (American); 27, Como (variable ratio); 28, Foster; 29, Magic; 30, Hart & Hegeman.

Radio Set Owners' Information

VOLUME FROM A CRYSTAL SET

(26) Absalon Raymundo, of Manila, P. I., asks:

Ques.—At present I have a crystal set. Will you tell me if my set will give much better results if I build a 90- or 100-foot cage antenna, instead of my present 100-foot single-wire antenna?

How can I make my crystal set operate an average loud speaker?

How is a common loud speaker unit wound?

Ans.—The use of a 90- or 100-foot cage antenna will not give you much better results. It may improve reception to some extent but on the whole the single wire antenna you have at present is just about as good. A change is not advised.

If you wish to operate a loud speaker from your crystal set you will have to install a two-stage audio-frequency amplifier. There is no other satisfactory method. For the sake of economy use dry-cell tubes of the

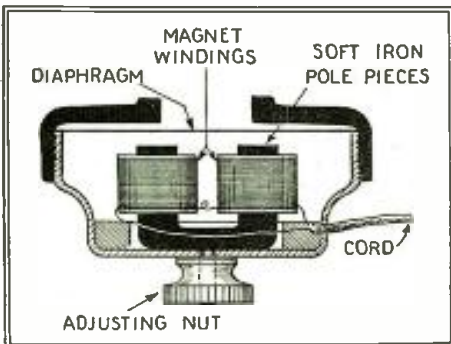

Showing the details of a loud speaker unit designed for use with a horn.

UV-199 type or C-299 type; a UX or CX 120 power tube in the last stage would be of great advantage. The circuit diagram for such an amplifier is again published, this month. The phone terminals on your crystal set would connect to the two amplifier posts marked "input."

A common loud speaker unit is nothing more than a magnified head-plate. It consists of one or two soft-iron pole pieces wound with many turns of very fine wire. The assembly functions as an electro-magnet. The diaphragm is mounted directly over the pole pieces. Any current flowing through the windings of the electro-magnet creates a magnetic field which attracts or repels the diaphragm, depending on the direction of the current flow, and vibrates the air at the same frequency as the changes in the audio-frequency current.

The accompanying sketch shows a loud speaker unit in detail.

THIS page constitutes what is to be known as the SET OWNERS' INFORMATION department, and is to be conducted regularly each month in RADIO NEWS. The purpose of the department is to furnish assistance to those readers who have not yet acquired any extensive knowledge of radio, but who are the possessors of radio receivers and wish to know how to handle them.

There is always new blood coming into the fraternity of radio enthusiasts; and it is obviously unreasonable to expect that they can intelligently read the articles which are written for the more experienced fans. Consequently this new department has been started for their benefit; and we invite anyone who desires to do so, to write an account of his troubles to the editor of this department. No letters will be answered by mail. The editor will select from the letters which he receives those queries that seem to be of most practical interest to all, and will answer them fully and in detail each month. There will be no charge for this service. Simply write to SET OWNERS' INFORMATION DEPARTMENT, RADIO NEWS, 53 Park Place, New York City.

ELECTRIC-LIGHT AERIALS

(28) E. W. Woodward, of Mount Vernon, N. Y., asks:

Ques.—I have heard various opinions expressed relative to the advantages and disadvantages of electric-light aerials; and, in view of the confusion, would welcome some authoritative information on the subject, since I would favor the use of such an arrangement. Furthermore, I should like to have details as to how an electric-light line is employed as an aerial.

Ans.—Opinions do differ, due primarily to the fact that the conditions surrounding such a system are never quite the same. First, the efficiency of an electric-light line as an aerial is dependent on the distance between the power house and the location of the receiving set, or, in other words, on the actual length of the wires. It is apparent that an exceptionally long line has a comparatively high resistance, and resistance is a factor that we are not inclined to allow in any portion of our receiving system. Nevertheless, a long line functions well as a collector of radio energy; likewise of local electrical disturbances. Furthermore, such a stretch of wire, employed as an aerial, affects the operation of the receiver and introduces broad tuning.

A short electric-light line functions quite satisfactorily, providing that there are no

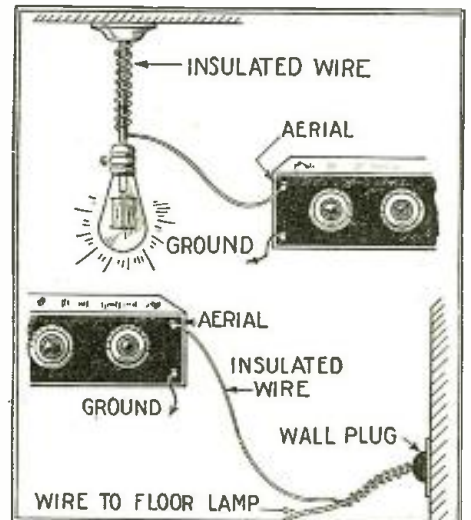

Showing two simple ways of employing electric light wires for an aerial. Insulated wire is wound around the fixture or lamp cord.

"B" BATTERY ELIMINATORS

(27) Clyde L. Housen, of Baltimore, Md., asks:

Ques.—I have a five-tube tuned-radio-frequency set with a power tube in the last audio stage. I use 135 volts "B" battery on this tube and get very good volume. I think it would be more convenient if I had a "B" battery eliminator; but before buying one I would like to know if present types will pass enough current for operating a power tube. The lighting current here is 110 volts D.C.

Ans.—Most of the "B" battery eliminators on the market at the present time will supply approximately 60 milliamperes of current, which is sufficient for most any type of set. You have, however, the voltage to worry about. Since the electric power in your house is direct current, it will not be possible to obtain a voltage much above 95. However, 95 volts will do fairly well, even for a power tube, though 135 volts will give much better results.

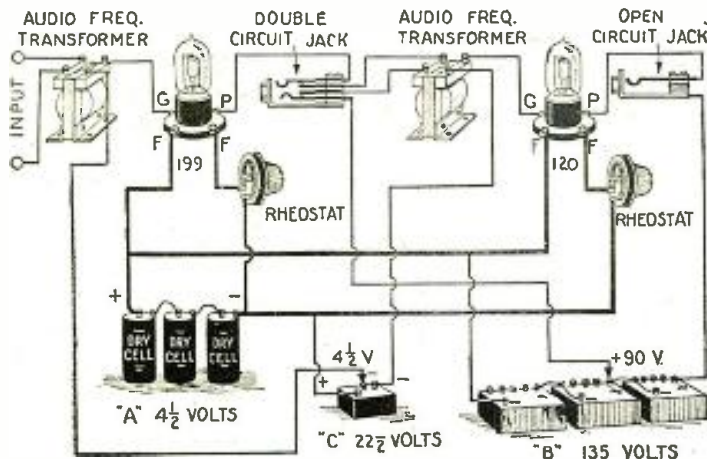

Circuit diagram of a two-stage audio-frequency amplifier, using 4½ volt dry-cell tubes. The tube in the last stage is a power amplifier and should give sufficient volume under most conditions.

serious leakages either through insulators or by a large "capacity to earth."

Unfortunately there is no satisfactory means for adjusting the electrical length of a light line; though different capacities of fixed condensers connected in series with the line and the receiver will help materially in getting the best results from the system.

It must be remembered that, in many cases, the electric-light lines are run underground. In such a case most of the energy is picked up by the wiring in the house, which is, of course, above ground. The underground wiring is not effective except through presenting a large capacity to earth. For this reason we can assume that the far end of the house wiring is grounded and so completes its circuit through the ground connection on the receiving set; somewhat in the manner of a large loop aerial.

The electric-light wires can be used as an aerial by employing any of the so-called lamp-socket antennae on the market; or a good length of insulated wire can be wrapped around any portion of one of the electric light fixtures; or the cord leading from

(Continued on page 276)

List of Broadcast Stations in the United States

Radio Call Letter	BROADCAST STA. Location	Wave (Meters)	Power (Watts)	Radio Call Letter	BROADCAST STA. Location	Wave (Meters)	Power (Watts)	Radio Call Letter	BROADCAST STA. Location	Wave (Meters)	Power (Watts)	Radio Call Letter	BROADCAST STA. Location	Wave (Meters)	Power (Watts)
KDKA	East Pittsburgh, Pa.	369.1	Var.	KFYF	Oxnard, Calif.	265.4	10	WBAO	Decatur, Ill.	270	100	WFBR	Baltimore, Md.	254	100
KDLR	Devils Lake, N. D.	231	5	KFYJ	Houston, Texas	238	10	WBAP	Fort Worth, Texas	475.9	1500	WFBS	Galesburg, Ill.	254	20
KDYL	Salt Lake City, Utah	216	50	KFYO	Texarkana, Tex.	209.7	10	WBAY	Nashville, Tenn.	212	100	WFDF	Flint, Mich.	234	100
KFAB	Lincoln, Neb.	340.7	1000	KFYR	Bismarck, N. Dak.	218	10	WBAX	Wilkes-Barre, Pa.	256	100	WFI	Philadelphia, Pa.	391.5	500
KFAD	Phoenix, Ariz.	273	100	KGAR	Tucson, Ariz.	243.8	500	WBBL	Richmond, Va.	299	50	WFKB	Chicago, Ill.	217.3	500
KFAF	San Jose, Calif.	217.3	50	KGO	Oakland, Calif.	361.2	4000	WBBM	Chicago, Ill.	226	1500	WFLR	Brooklyn, N. Y.	205.4	100
KFAU	Boise, Idaho	280.2	750	KGTT	San Francisco, Calif.	266.8	50	WBBP	Petoskey, Mich.	238	200	WGAL	Lancaster, Pa.	248	10
KFBB	Harre, Mont.	275	50	KGU	Honolulu, Hawaii	270	500	WBBR	Rossville, N. Y.	416.4	500	WGBB	Freeport, N. Y.	214	500
KFCB	San Diego, Calif.	215.7	50	KGW	Portland, Ore.	491.5	1000	WBSB	New Orleans, La.	252	50	WGBG	Memphis, Tenn.	278	10
KFBK	Sacramento, Calif.	218	100	KGY	Lacey, Wash.	246	50	WBBW	Norfolk, Va.	222	50	WGBF	Evansville, Ind.	236	500
KFBL	Everett, Wash.	221	100	KHJ	Los Angeles, Calif.	405.2	500	WBBY	Charleston, S. C.	268	10	WGBI	Scranton, Pa.	240	10
KFBS	Trinidad, Colo.	228	15	KHQ	Spokane, Wash.	391.5	1000	WBBZ	Chicago, Ill.	215.7	50	WGBR	Marshfield, Wis.	229	10
KFBU	Laramie, Wyo.	270	500	KJBS	San Francisco, Calif.	220	5	WBCN	Chicago, Ill.	266	500	WGBS	New York, N. Y.	315.6	500
KFCB	Phoenix, Ariz.	228	100	KJR	Seattle, Wash.	384.4	1000	WBDC	Grand Rapids, Mich.	256	500	WGBU	Pulford, Fla.	278	500
KFDD	Boise, Idaho	278	50	KLDS	Independence, Mo.	440.9	1000	WBES	Takoma Park, Md.	222	100	WGBX	Orono, Me.	234.2	500
KFDM	Beaumont, Tex.	315.6	500	KLS	Oakland, Calif.	250	250	WBNY	New York, N. Y.	322.1	500	WGCP	Newark, N. J.	252	500
KFDX	Shreveport, La.	250	100	KLX	Oakland, Calif.	508.2	500	WBOQ	Richmond Hill, N. Y.	256	100	WGCS	Chicago, Ill.	250	500
KFDY	Brookings, S. Dak.	273	100	KLZ	Denver, Colo.	266	250	WBRC	Birmingham, Ala.	218	50	WGHS	Clearwater, Fla.	266	500
KFDZ	Minneapolis, Minn.	231	10	KMA	Shenandoah, Iowa	252	500	WBRE	Wilkes-Barre, Pa.	251	100	WGHP	Detroit, Mich.	270	1500
KFEC	Portland, Ore.	218	50	KMJ	Fresno, Calif.	234	50	WBT	Charlotte, N. C.	275	250	WGMU	Richmond Hill, N. Y.	236	100
KFEL	Denver, Colo.	251	50	KMMJ	Clay Center, Neb.	228.9	1000	WBZ	Springfield, Mass.	331.1	2000	WGN	Chicago, Ill.	302.8	1000
KFEQ	Oak, Neb.	268	500	KMO	Tacoma, Wash.	250	100	WBZA	Boston, Mass.	212	250	WGR	Buffalo, N. Y.	319	750
KFEY	Kellogg, Idaho	235	10	KMOX	Kirkwood, (St. Lo.), Mo.	280.2	5000	WCAC	Storrs, Conn.	275	500	WGST	Atlanta, Ga.	270	500
KFFP	Moberly, Mo.	212	50	KMTR	Los Angeles, Calif.	238	500	WCAD	Canton, N. Y.	263	250	WGY	Schenectady, N. Y.	379.5	10,000
KFGQ	Boone, Iowa	226	10	KNRC	Los Angeles, Calif.	208.2	250	WCAG	Pittsburgh, Pa.	461.3	500	WHA	Madison, Wis.	535.4	750
KFH	Wichita, Kans.	268	500	KNX	Los Angeles, Calif.	336.9	1000	WCAL	Northfield, Minn.	336.9	500	WHAD	Milwaukee, Wis.	275	500
KFHA	Gunnison, Colo.	252	50	KOA	Denver, Colo.	322.1	5000	WCAN	Camden, N. J.	236	250	WHAM	Rochester, N. Y.	278	100
KFHL	Oskaloosa, Iowa	210	10	KOAC	Corvallis, Ore.	230.2	500	WCAM	Baltimore, Md.	275	100	WHAP	New York, N. Y.	431	500
KFI	Los Angeles, Calif.	468.5	4000	KOB	State College, N. M.	348.6	1000	WCAP	Washington, D. C.	468.5	500	WHAR	Atlantic City, N. J.	275	500
KFIF	Portland, Ore.	248	100	KOCH	Omaha, Neb.	258	250	WCAR	San Antonio, Texas	263	2000	WHAS	Louisville, Ky.	399.8	500
KFIO	Spokane, Washington	265.3	100	KOCW	Chickasha, Okla.	252	200	WCAT	Rapid City, S. D.	210	50	WHAZ	Troy, N. Y.	379.5	1000
KFIQ	Yakima, Wash.	256	100	KOIL	Council Bluffs, Iowa	278	500	WCAU	Philadelphia, Pa.	277.6	500	WHBC	Canton, Ohio	251	10
KFIU	Juneau, Alaska	226	10	KOWW	Walla Walla, Wash.	258	500	WCAX	Burlington, Vt.	250	100	WHBJ	Beaufontaine, Ohio	222	20
KFIZ	Fond du Lac, Wis.	273	100	KPO	San Francisco, Calif.	428.3	1000					WHBF	Rock Island, Ill.	222	100
KFJB	Marshalltown, Iowa	218	10									WHBG	Iarrisburg, Pa.	231	20
KFJC	Junction City, Kansas	218.8	10									WHBJ	Fort Wayne, Ind.	234	50
KFJF	Oklahoma City, Okla.	261	500									WHBL	Chicago, Ill.	215.7	50
KFJL	Astoria, Ore.	216	10									WHBM	Chicago, Ill.	215.7	20
KFJM	Grand Forks, N. Dak.	278	100									WHBN	St. Petersburg, Fla.	238	10
KFJR	Portland, Ore.	263	50									WHBP	Johnstown, Pa.	256	100
KFJY	Fort Dodge, Iowa	246	50									WHBQ	Memphis, Tenn.	233	50
KFJZ	Fort Worth, Texas	251	50									WHBU	Anderson, Ind.	218.8	10
KFKA	Greeley, Colo.	273	50									WHBW	Philadelphia, Pa.	215.7	100
KFKU	Lawrence, Kans.	275	500									WHBY	West De Pere, Wis.	250	50
KFKX	Hastings, Neb.	288.3	5000									WHDI	Minneapolis, Minn.	278	500
KFKZ	Kirksville, Mo.	225.1	10									WHEC	Rochester, N. Y.	258	100
KFLR	Albuquerque, N. Mex.	251	100									WHK	Cleveland, Ohio	272.6	1000
KFLU	San Benito, Tex.	236	20									WHN	New York, N. Y.	360	500
KFLV	Rockford, Ill.	229	100									WHO	Des Moines, Iowa	526	5000
KFLX	Galveston, Tex.	240	10									WHT	Deerfield, Ill.	238	2500
KFLZ	Anita, Iowa	273	100									WIAD	Philadelphia, Pa.	250	750
KFMR	Sioux City, Iowa	261	100									WIAS	Burlington, Iowa	254	100
KFMX	Northfield, Minn.	336.9	500									WIB	Madison, Wis.	236	100
KFNF	Shenandoah, Iowa	263	1000									WIBG	Elkins Park, Pa.	222	50
KFOA	Seattle, Wash.	451.3	1000									WIBH	New Bedford, Mass.	209.7	30
KFOB	Burlington, Calif.	226	50									WIBI	Flushing, N. Y.	218.8	50
KFON	Long Beach, Calif.	233	500									WIBJ	Chicago, Ill.	215.7	50
KFOO	Salt Lake City, Utah	236	250									WIBM	Chicago, Ill.	215.7	10
KFOR	David City, Neb.	226	100									WIBO	Chicago, Ill.	226	1000
KFOT	Wichita, Kans.	231	50									WIBR	Wilmington, W. Va.	216	50
KFOX	Omaha, Neb.	218	100									WIBS	Elizabeth, N. J.	202.6	10
KFOY	St. Paul, Minn.	232	50									WIBU	Poynette, Wis.	222	20
KFPL	Dublin, Texas	252	15									WIBW	Logansport, Ind.	220	100
KFPM	Greenville, Texas	242	10									WIBX	Utica, N. Y.	205.4	150
KFPR	Los Angeles, Calif.	230.6	500									WIBZ	Montgomery, Ala.	231	10
KFPW	Carterville, Mo.	258	20									WIL	St. Louis, Mo.	273	250
KFPY	Spokane, Wash.	266	100									WIOD	Miami Beach, Fla.	247.8	1000
KFQA	St. Louis, Mo.	280.2	5000									WIP	Philadelphia, Pa.	508.2	500
KFQB	Fort Worth, Texas	508.2	1000									WIAD	Waco, Texas	352.7	500
KFQD	Anchorage, Alaska	227.1	100									WIAG	Norfolk, Neb.	270	200
KFQF	Iowa City, Iowa	224	10									WIAK	Kokomo, Ind.	254	50
KFQU	Alma (Holy City) Calif.	217.3	100									WIAM	Cedar Rapids, Iowa	268	100
KFQW	North Bend, Wash.	215.7	50									WIAR	Providence, R. I.	305.9	500
KFQZ	Hollywood, Calif.	225.4	50									WIAS	Pittsburgh, Pa.	336.9	500
KFRB	Beaville, Tex.	248	250									WIAX	Jacksonville, Fla.	336.9	1000
KFRD	San Francisco, Calif.	267.7	50									WIJ	Joliet, Ill.	208.8	50
KFRU	Columbia, Mo.	199.7	500									WJBB	St. Petersburg, Fla.	254	10
KFRW	Olympia, Wash.	218.8	50									WJBC	La Salle, Ill.	234	100
KFSD	San Diego, Calif.	216	500									WJBI	Red Bank, N. J.	218.8	250
KFSG	Los Angeles, Calif.	275	500									WJBK	Ypsilanti, Mich.	233	10
KFUL	Galveston, Tex.	258	50									WJBL	Decatur, Ill.	270	500
KFUM	Colorado Springs, Colo.	239.9	100									WJBO	New Orleans, La.	268	100
KFUD	St. Louis, Mo.	545.1	500									WJBR	Omro, Wis.	227.1	50
KFUP	Denver, Colo.	234	50									WJBT	Chicago, Ill.	233	500
KFUR	Ogden, Utah	221	50									WJBU	Lewisburg, Pa.	211.1	100
KFUS	Oakland, Calif.	256	50									WJJD	Moosheart, Ill.	370.2	500
KFUT	Salt Lake City, Utah	261	100									WJR	Pontiac, Mich.	518.9	5000
KFVU	Oakland, Calif.	220	100									WJY	New York, N. Y.	405.2	1000
KFVD	San Pedro, Calif.	205.1	50									WJZ	Bound Brook, N. J.	451.3	50,000
KFVE	St. Louis, Mo.	210	500									WKAF	Milwaukee, Wis.	261	5000
KFVG</															

The Latest Discoveries in the Range of Electromagnetic Wave-lengths

By PROF. BORIS WEINBERG (Leningrad)

The old schoolbooks spoke of Three Imponderable Agents—Light, Heat and Electricity. Light and Radio have been brought, by two Russian women scientists, to a meeting point in the range once assigned to Radiant Heat. All are manifestations of electro-magnetic waves differing only in frequency.

THE latest achievements in the study of the great ocean of electromagnetic waves have recently been performed, in the realm of the ultra-shortest, by two Russian women, Alexandra Andreevna Glagoleva-Arkadieva, of Moscow, and Maria Afanasievna Levitskaia, formerly of Tashkent, and now of Leningrad. Their researches have closed the gap which exists between the previously-measured range of "light" (visible and invisible) wave-lengths and the range of radio or Hertzian wave-lengths.

This gap, which is only a little more than an octave in frequency, covers the band of

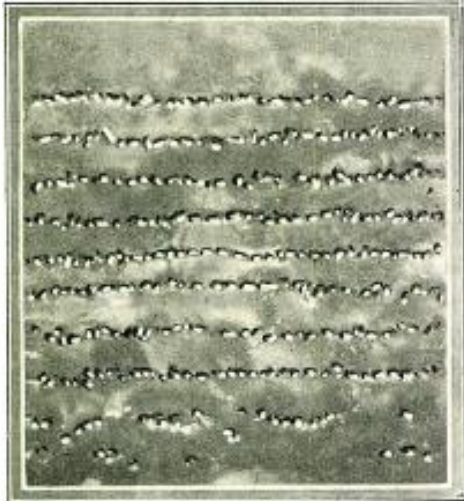

Fig. 6. A magnified view of the metal beads, by discharges between which the ultra-shortest known radio waves are generated.

wave-lengths of 800 to 1,800 μ (μ , as a measure of length, being a "micron," one millionth of a meter, .001-mm, or .00003937-inch), or from approximately one-thirtieth to one-fourteenth of an inch. Waves longer than these had previously been generated as short Hertzian waves: waves shorter had been detected and measured as rays of infra-red "light."

Let us consider these experiments from the standpoint of the history of physics; and look at Fig. 1, which shows the gradual exploration and mapping of the Meridian of Radiant Energy in its length throughout the Ocean of the

Unknown. In this figure time of discovery is plotted, as well as the range of radiant energy known to physicists at each period.

EXPLORATION OF LIGHT

Prior to 1814, we may say, the Island of Visible Light had risen, sunk, and reappeared; while physicists battled over the Wave Theory of Light and the Corpuscular Theory. It appeared in the seventeenth century through the strenuous efforts of Huyghens and his fellow adherents to the ether-wave theory of light: it was several times destroyed, or at least obscured, by the attacks of Newton and those who followed him in upholding the theory that light is composed of infinitesimally small particles emitted by the luminous source. Only after what we may compare to a volcanic eruption, the ideas and experiments of Fresnel, did this island of knowledge take a permanent place on the scientific map. Its exploration slowly developed many peninsulas.

This little island extended over about an octave of frequencies from the shorter waves (higher frequencies) at the violet end of the visible spectrum, to the longer waves (lower frequencies) of the last visible red. Across this range, approximately in the middle, is drawn our Equator, or 0 parallel, the wave-length 0.54 μ (.00054 mm., or .0000213-inch) which corresponds to the maximum of energy in the spectrum of our greatest source of radiation, the Sun.

Soon out of the Ocean of the Unknown, appeared two prolongations of the island along this meridian—the Ultra-Violet and the Infra-Red, beyond the visible spectrum; so that we must now call it the Island of Light Waves. The writer would like to cite the names and dates of successful explorers with the advances which they effected along the wave-range; Stokes, (1863) 185 μ ($\mu = 1/1000 \mu$); Shuman, 1889) 100 μ ; Lyman (1914) 45 μ ; Millikan

(1924) 13.7 μ ; and in the opposite direction, Abney (1886) 0.98 μ ; Langley (1888) 25 μ ; Rubens (1896) 56 μ , (1910) 100 μ ; (1911) 343 μ ; or from latitudes 5 S (Short) to 9L (Long) on our map.

THE HERTZIAN WAVES

In 1863 Clerk Maxwell prophetically glimpsed in the far south—or shall we say the Far Long?—a remote Island of Electro-

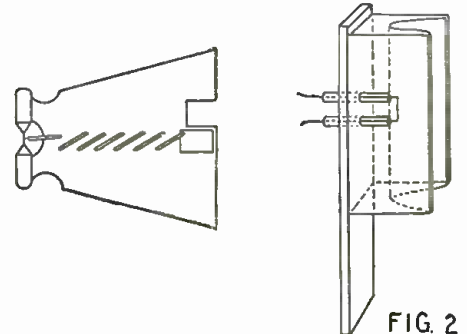

These "thermoelements" are placed in the focus of apparatus, which converges upon them the ultra-shortest radio waves, and respond with a current measured by a galvanometer.

magnetic Waves; but only in 1886 was it seen clearly above the ocean as Hertz's rays of electric force. This island, as first explored, extended from the parallel of 20L to that of 23L (566 to 4530 meter wave-lengths) along the Meridian of Radiant Energy. (Each unit represents an octave of frequencies—that is to say, it marks a doubling of frequency toward the right of Fig. 3, and a doubling of wave-length toward the left. The scale is logarithmic—see page 53, RADIO NEWS for July, 1926. It was, however, very quickly lengthened in both directions; to 18L by Lodge (1890); to 16L by Righi (1894); and to 13L by Lebedev (1895); and on the other hand to 26L by Blondlot (1891); 32L by Saunders (1891) and to 35 and 36L in some of the modern radio stations. No one now doubts that the ordinary alternating-current generator creates waves which extend as far as 43L (5,000 kilometers = 60 cycles) on the chart, or that there is no possible limit in this direction; but nobody cares to investigate such ultra-long waves.

The similarity of the typical outlines of the Island of Light Waves to that of the Hertzian Waves increased the interest of physicists in the exact terminations of the capes of Ultra-Violet and Infra-Red on the former, which, as we see on the map, had been extended gradually between the parallels of 2S and 6L.

Meanwhile, during the period covered by the above paragraphs, Roentgen had discovered the X-rays; Becquerel, the Curies and hundreds of other distinguished investigators had located a chain of islands of knowledge on the meridian of radio-activity; Lord Rayleigh, by discovering the inert constituents of the atmosphere, had originated a whole group of them on the meridian of chemistry—and some daring physicists, guided rather by intuition or imagination, predicted the appearance of a remote Island of X-rays on our map.

ULTRA-SHORT RADIATION

It finally replaced (in 1912-13) the unknown waters in our chart after the ad-

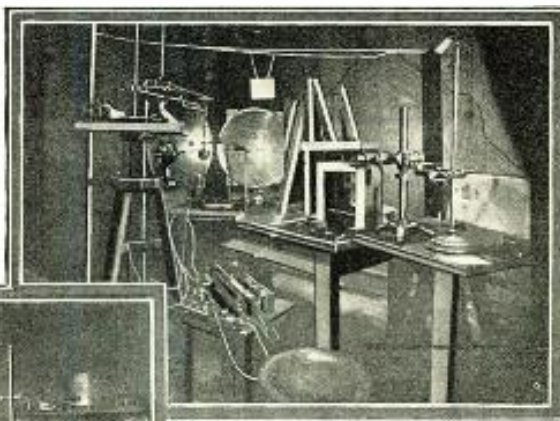

These are views of the apparatus, shown in the smaller picture at the top of the opposite page, and which is described in detail at the close of this article. The mirrors by which the shortest radio waves are reflected to a focus, like light, as seen; as well as the motor driving the "agitator" later described.

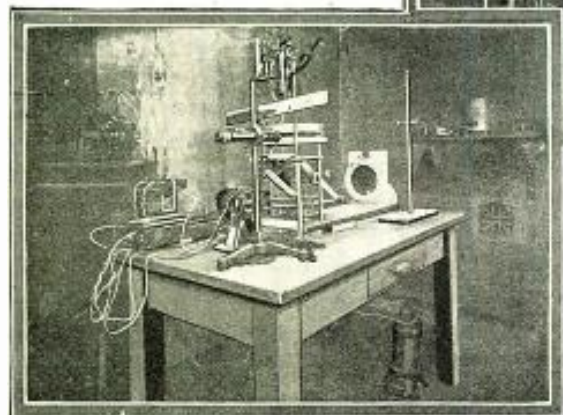

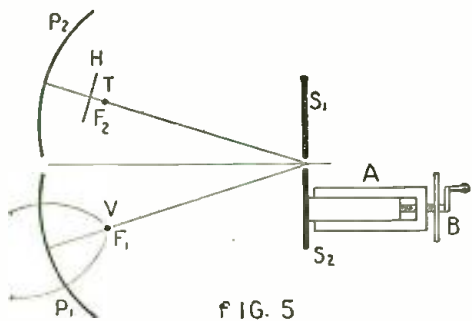

FIG. 5
One of the systems employed for collecting the ultra-shortest rays given off by the minute oscillators used. It is described on page 295.

mirable discoveries of Lane and Bragg, and gradually extended from near 8S or 2.1μ (Siegbahn, 1924) to 16 S or $.008\mu$ (Butterford and Andrada, 1914); while Lyman and Millikan were pushing along further and further the projection of Cape Ultra-Violet. The researches of many, but especially McLennan and Clark (1914) practically closed the gap between the latter and the cape of the longest X-rays; though, as it were, by only a low sandbank overflowed at times by the waves of sceptical criticism.

Finally, the researches of Glagoleva-Arkadieva and Levitskaia, described later in this article, have extended the range of the Hertz waves well beyond the position of the longest of the Infra-Red waves hitherto known; so that where the waters of the Ocean of the Unknown formerly lay we have a continuous well-mapped Island of Radiant Energy; ranging from the parallel which marks the longest to that of 16S (experimentally) and 18S (theoretically, Ellis, 1922) and probably even to 20S. In this direction of the Far Shortest, there seems to be a prolongation to be found in the Island of Penetrating Radiation ("cosmic rays") discovered by Millikan in 1925, which will extend somewhere in the region of parallels 23-24S. (The length of these waves is in the order of $.00005\mu$, or $2/1,000,000,000,000$ of an inch).

What part of the Island of Radiant Energy is useful in modern radiotelegraphy and telephony; or will be used in television? Not very long ago this part extended from about 29L to about 36L; (300

to 37,000 meters); but in late years activities have been devoted to waves as far down the scale as 24L and even 21L ($1/8$ of a meter). The writer is somewhat inclined to doubt that the shortest waves, in the order of tenths and hundredths of a millimeter, will ever supersede those of a few meters or tens of meters in length.

It is, however, one of the most difficult tasks connected with modern science, to predict what practical results will arise from a definite scientific discovery.

APPLICATIONS OF PURE SCIENCE

Let us take as an example William Thomson's paper on transient electric currents, published in 1853. In this paper, full of differential equations and their integrals, the future Lord Kelvin treated such questions as the action in the circuit of a galvanic battery at the instant of opening or closing the switch, and the still more absurd, at that period, connection of a Leyden jar in parallel with the terminals of a



Mme. Glagoleva-Arkadieva in her laboratory with the apparatus used in producing and measuring the shortest radio waves.

entirely useless until Hertz performed his historic experiments in 1886.

On April 25, 1895, there was a meeting of the Russian Physical Society, which was attended by many physicists, among them the writer. At this meeting Prof. A. S.

This shows the deflections of the galvanometer attached to a thermoelement upon which are concentrated the shortest radio (or longest light) waves, all of less than $1/32$ inch in length. The upper curve indicates the measured deflections, and the lower curve those theoretically computed. The λ indicates wave-lengths measured in thousandths (μ) of a millimeter.

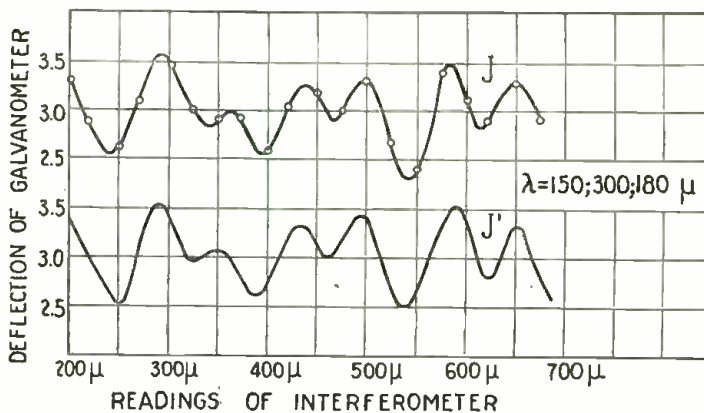

FIG. 3

battery. Who could then foretell that Thomson's formula for the period of an oscillatory discharge would be so valuable in everyday practice for the millions who are enjoying radio?

And then, too, Maxwell's equations, published in 1864 and incomprehensible even to many of the physicists of the latter part of the last century, and his complete electromagnetic theory of light, were considered

Popov repeated Hertz's experiments in oscillations, using an electric bell for decohering the coherer and, for the first time in the world's history, a sort of antenna, a meter high, which received signals through two stone walls over the enormous distance of 20 meters. Many of those present were unable to restrain a smile, when at the end of his lecture, Prof. Popov expressed a
(Continued on page 292)

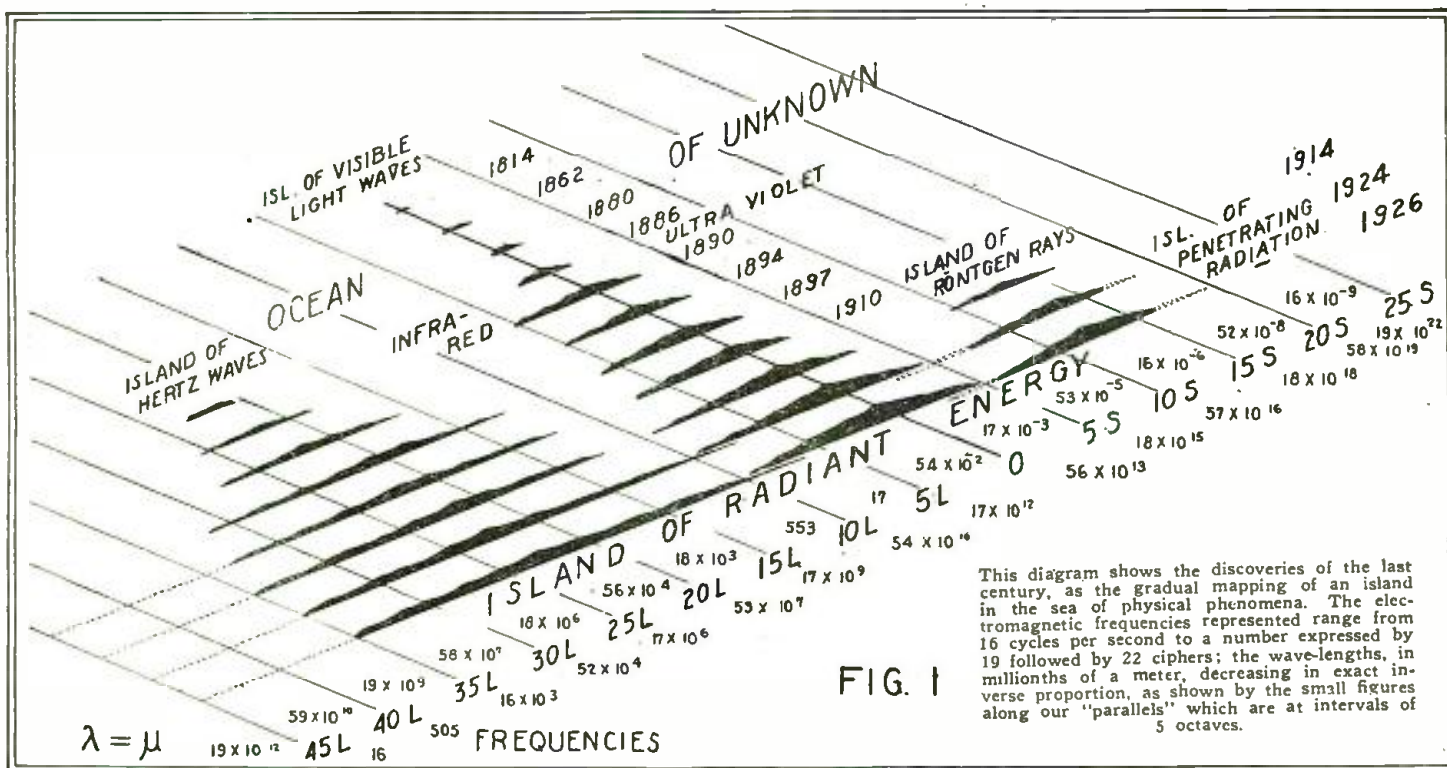

FIG. 1

This diagram shows the discoveries of the last century, as the gradual mapping of an island in the sea of physical phenomena. The electromagnetic frequencies represented range from 16 cycles per second to a number expressed by 19 followed by 22 ciphers; the wave-lengths, in millionths of a meter, decreasing in exact inverse proportion, as shown by the small figures along our "parallels" which are at intervals of 5 octaves.

New Developments in Radio Apparatus

By G. C. B. ROWE

Here are descriptions of some of the latest radio products in the American and foreign markets. Certainly the design, electrical, mechanical and artistic is being improved with every new piece of apparatus that comes on the market.

THE statement has been many times made, that "the radio industry is still in its infancy"; but judging by the appearance of some of the receivers on the market at the present time, this infant is indeed a lusty one. It is truly remarkable that such extraordinary progress should have been made in so short a time.

For instance, look over the advertising pages of some old radio magazines—and by *old* we mean of two or three years ago. It will be seen that the sets then had manifold controls; for audio-frequency amplifiers, transformers were used exclusively, and the word quality, in respect to what came out of the loud speaker, was very seldom mentioned. These conditions are considerably altered at the present time and it is interesting to see just what has brought about the change.

It is the old story of supply and demand, with the accent on the latter word. As more and more people became interested in the new game several years ago, there was available for them just whatever the manufacturers had on hand; and the public, being anxious to listen in to even the few broadcast stations then in operation, was only too eager to purchase. The result was that there were too many receivers bought which proved to be almost worthless after they were set up in the home; for the very simple reason that it was a day's work to tune in any station with them. Also, the majority of the stations at that time were broadcasting on 360 meters and that meant interference of the highest order. In other words, radio in those days was nothing to play with, for anyone who thought a "B" battery was a company of artillerymen.

However, as time went on, two or three manufacturers saw the possibilities there were for a set that could be tuned by anyone, whether he had an engineer's degree or not. Sets that were more easily tuned appeared on the market, and then there was

This bottom view of the receiver shows at the left the resistances and condensers of the resistance-coupled A.F. amplifier. The rheostat, controlling the volume, is immediately behind the panel at the left. On the right is the antenna coupler, a portion of the primary inductance and also the coupling being variable, the latter forming the sensitivity control.

Photos courtesy of J. B. Ferguson, Inc.

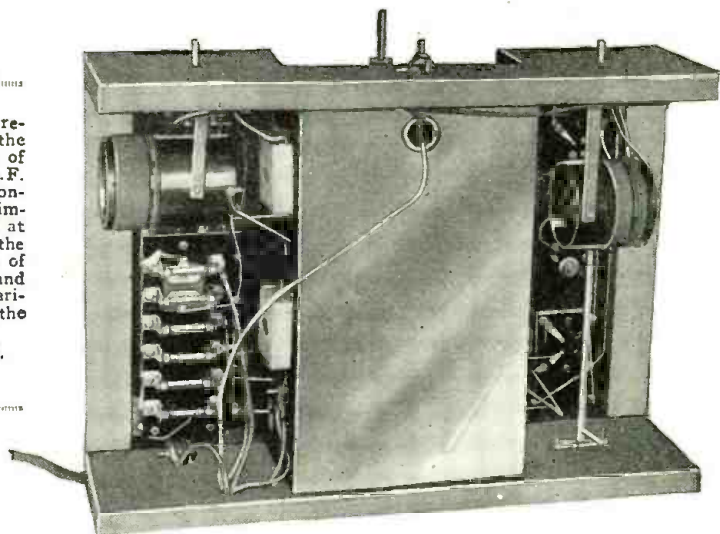

a cry from the radio public, "Give us more like that!"

The latest manifestation of that cry—or

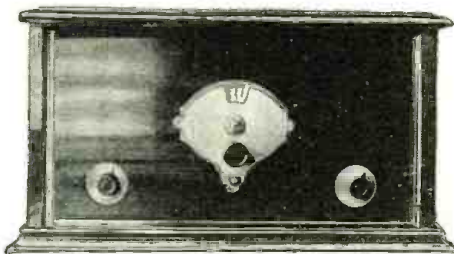

The panel, which is of wood, carries the tuning control, beneath which is the filament switch, and the volume and sensitivity controls, the latter two being seldom adjusted.

should we say, demand?—was shown in the Ideal Set Contest, which RADIO NEWS recently conducted. In the detailed analysis

of the answers to this contest, it was found that the majority of the contestants demanded a receiver to have but one control, with a built-in loud speaker, and built-in loop antenna; while numerous minor improvements were suggested for the convenience of the operator.

Of course the most important of these changes, which we are considering, is the single-control feature; and it is this that has proved to be such a stumbling block to many set designers. Wherever there have been one or two stages of radio-frequency amplification in the circuit, it seemed for a long time that it was impossible to operate successfully with a single tuning control. However, the gang tuning condenser was produced and it, to a great extent, has eliminated this bugaboo.

A SINGLE-CONTROL RECEIVER

In the illustrations on this page are various views of a receiver in which the single-control principle is developed to a wonderful degree. Although there are three knobs on the panel, two of these need be adjusted only occasionally; the main tuning dial is all that it is necessary to manipulate for receiving a station.

Aside from the single-control feature this receiver is worthy of note because of the manner in which it is designed and constructed. Let us first consider the circuit, which consists of two stages of tuned-radio-frequency amplification, detector and three stages of resistance-coupled audio-frequency amplification. This means that there are six tubes employed in the receiver, five being of the 201-A type; the sixth, which is in the last stage of the audio-frequency amplifier, may be a power-amplifier tube, although this is not absolutely necessary.

As may be seen from the illustration the three tuning condensers are on the same shaft, as also the secondary of the radio-frequency transformer. These three condensers tune the antenna circuit and the two stages of radio-frequency amplification.

As is evident also from the illustrations, the receiver is completely shielded, and its copper shield is used as well for eliminating some of the connections. This is done by grounding various pieces of apparatus, that should have a common connection, to the shield; and in this way the resistance and capacity effects of leads are eliminated. Naturally, with such extensive shielding,

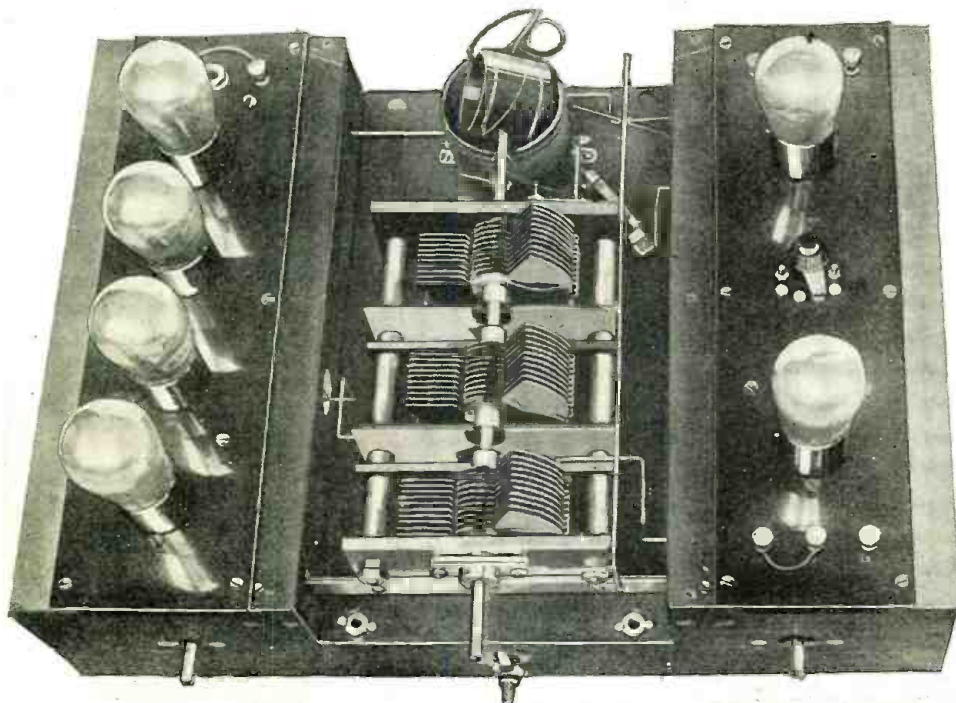

Here is a top view of the receiver with the upper shield that fits over the condensers removed. At the rear of the left sub-panel are the "C" battery binding posts and the phone jack. On the right sub-panel in front are binding posts for a loop antenna.

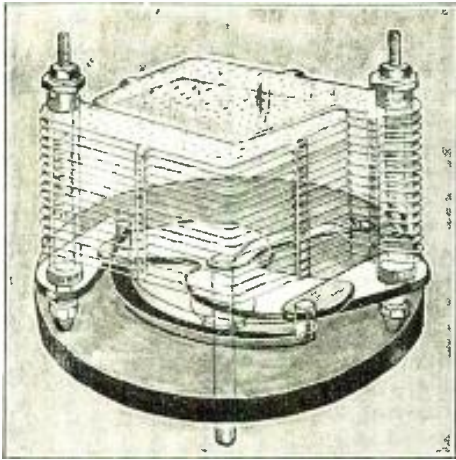

The cams guided by grooves in the bakelite plate give to the rectangular plates a motion equivalent to that of an S.L.F. condenser. Courtesy of Lee Elec. & Mfg. Co.

there is no body-capacity effect whatsoever. The audio-frequency amplifier, being of the resistance-coupled type, is capable of giving quality of reproduction of the highest order. As mentioned above, the general efficiency of the receiver will be increased if a power amplifier tube is used in the last stage; and for this purpose there has been included among the battery leads one for supplying the necessary high voltage to the plate of this tube. This should be in the neighborhood of 135 volts; and in the majority of tubes of this type there should be impressed a negative grid bias of about 9 to 12 volts. It will be noticed that on the left sub-panel, at the rear, there are two binding posts which are shorted. It is here that the "C" battery is connected, when one is used for this stage.

The volume control, which is the left knob, operates a rheostat in the filament circuit of the first two tubes in the receiver. By a regulation in this manner a greater range of volume may be secured and, what is far more important, there is less chance of introducing distortion. The sensitivity control, which is the small knob on the right of the tuning dial, varies a rotor on which is wound a portion of the secondary of the antenna coupler. On the right sub-panel there is a four-point inductance switch, which shorts out portions of the inductance in the primary of the antenna coupler. This switch is placed in the circuit in order that the receiver may be adapted to any type of antenna, whether it is erected outdoors or indoors, or a loop antenna is employed.

The main tuning dial of the receiver is calibrated in wave-lengths instead of the usual degrees. This incidentally is another feature that most of the set owners demanded in the Ideal Radio Set Contest mentioned above. There is, however, more or less of a hazard in putting on the market a receiver calibrated in this fashion; unless there be

provided some method of compensating for the length of antenna that will be used in conjunction with the set. This adjustment is cared for, in the case of this receiver, by the inclusion of the four-point inductance switch mentioned in the last paragraph.

The cabinet which encloses this receiver is of dark wood, and instead of the usual composition insulating material, there is employed for the panel the same sort of wood which is used throughout; thus giving a uniform appearance to the whole and more than ever making the set a piece of furniture that will harmonize with almost any surroundings.

There are provided also battery connections in the form of leads having insulation of different colors and suitably tagged; so that there is very little chance of the batteries being connected incorrectly.

A FRICTION-DRIVE VERNIER DIAL

Ever since the problem of separating stations on the tuning dials of a receiver has been under survey, various methods of "vernier" or slow-motion systems have been undergoing development. One of the earliest was the eraser of a pencil, held against the panel and dial, and then rotated in the fingers. This crude method gave some one the idea of manufacturing a small rubber disc that turned the dial when a knob was rotated.

is a small window, through which may be seen the divisions on the dial as it is rotated. At the lower end of the plate there is a heart-shaped spring which presses against the small roller which turns the dial. This roller, which is grooved, is pressed against the dial by the spring, and is turned by means of the knob on the outside of the plate. In the illustration the position of the inside dial is indicated by the white dotted line.

The method of attaching the dial to the condenser shaft is very simple and there is no set-screw with which to bother. Through the center of the dial is placed a split bushing, the inside end (that towards the plate) being threaded. The shaft of the condenser is run through this bushing and the nut tightened. This forces the bushing tightly against the shaft and the dial cannot slip, as there is equal pressure on every part of the circumference of the shaft.

A VARIABLE INDUCTANCE COIL

Again we hark back to the good old days, when the height of the average radio fan's ambition was to own a good regenerative set which used honeycomb coils as primary, secondary and tickler inductances. Do you recollect how the cash was hoarded to buy a set of these coils; and then, when we had put them in the set, we found that it was im-

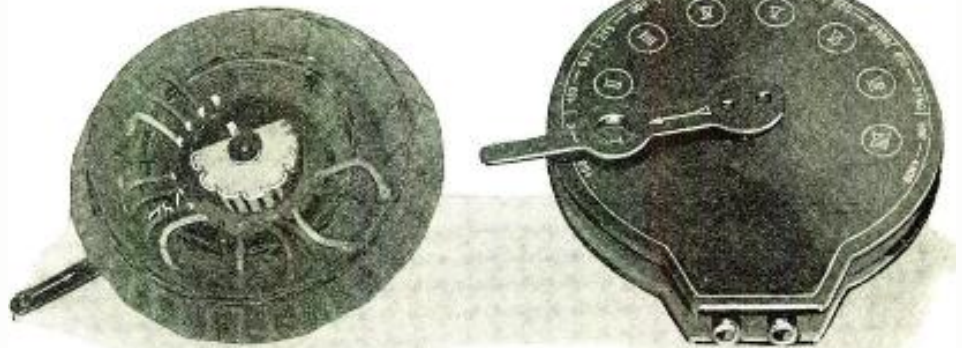

In the left view the cover of the inductance has been removed to show the type of winding. The wave bands covered are indicated at the various points in the right hand view. Courtesy of Ideal Radiotelefon & Apparatefabrik.

Then came the various intricate dials, gaining their vernier properties by complicated gearing arrangements. There was found to be often a great fault in these dials, as, due to the very nature of the gears, there was apt to be play in them that was very difficult to eliminate—so that the dials were more or less useless for very accurate tuning. After these came dials for use with straight-line-capacity condensers, which would give them, by mechanical means, the effect of straight-line frequency condensers.

In the dial shown in the accompanying illustrations there is the vernier action; but due to the simplicity of construction, there is no danger of backlash or slipping. The central portion of the plate, which is attached to the panel of the receiver and beneath which the dial proper rotates, is raised in order that the locking device on the dial may have room. In the upper part of this plate there

possible to get up or down the scale of wave-lengths, as we wished? The answer was then to go out to the radio store and purchase another trio.

As with everything else in the line of radio apparatus, inductance coils have been greatly improved. In the accompanying illustration is shown a new type of inductance, made in Berlin, Germany, which is variable. Up to this time great difficulty has been experienced in making an efficient variable inductance because there enter into the (Continued on page 278)

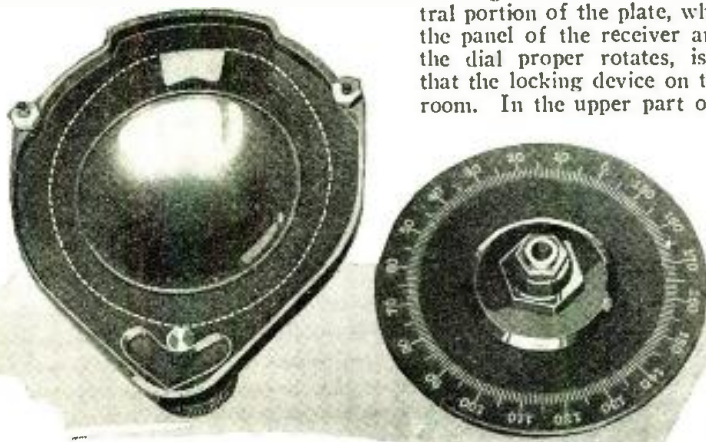

The two parts of the vernier dial are shown at the left and the panel appearance at the right. The dotted circle indicates the position of the dial when in place. The locking device for fastening the dial to the shaft is noteworthy.



Photos courtesy of Kurz-Kasch Co.

An Ultra-Modern Radio Factory

By B. H. BAKER

As radio has taken its rightful place as an American industry, methods are being developed for mass production, the ultimate goal of every manufacturing development. Here is a description of the methods employed for the making of a complete receiver.

THE views of a large factory devoted to all stages of radio set manufacture, which accompany this article, offer conclusive evidence that the manufacture of radio receivers has taken its place as one of the industries in which highly systematized, mass production is an essential of success. A new building, erected in 1922, has been rapidly outgrown, necessitating an addition in 1925, which increased the floor space by approximately 60,000 square feet. All is constructed of reinforced concrete and

represents the most advanced type of factory design.

As the visitor approaches the factory, he is impressed not only by the attractiveness of the building itself, but also by the pleasing, well-kept grounds which surround it. Inside the factory, the first impression is probably that of an unusually high degree of cleanliness. A big factor in the maintaining of this condition is the employment of the modern type of factory window to the greatest possible extent. In addition to thus obtaining

the maximum amount of sunlight, the inside wall areas and ceilings are finished in white enamel.

It might be mentioned here that these three factors of sunlight, cleanliness and good air play a big part in creating a loyal, capable force of men and women. Labor turnover is unusually small. Large recreation and rest rooms, a tennis court, dances and parties all contribute to make this factory and this organization especially successful from this viewpoint.

The arrangement of the various departments has been carefully worked out in order to facilitate the progression of operations which convert the raw material into the finished apparatus. Incidentally, every part of the receiver is made in this factory, with the exception of cabinets and wire.

The first floor is devoted entirely to the processes of turning raw material into parts for assembly into the various units. One section of this floor is a completely equipped toolroom. Here, with the aid of the finest machines available, expert toolmakers turn out all of the special tools, dies, fixtures and jigs which are required.



Photos courtesy of A. H. Grebe & Co., Inc.



Above is shown the final assembly of the sets, with the operators who wire them. Belt-conveyor systems are used throughout the plant; and a section is here shown, carrying the sets from the workers.



At the right is shown the section of the plant where parts are assembled. In the foreground are operators assembling and inspecting variable condensers.

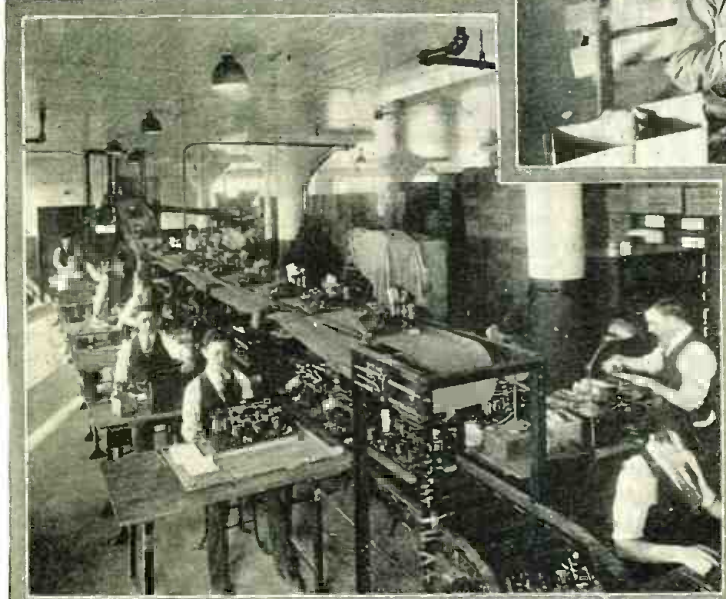

AUTOMATIC MACHINERY

In another section of this floor is a press department consisting of a battery of eight of the latest type presses, on which are stamped out all of the sheet metal parts used. Here, also, is a battery of eight automatic screw machines for turning out the special screws and machine parts.

The importance of molded composition in modern radio construction is evidenced by the ten electrically heated and thermostat-controlled molding presses which occupy another section of the first floor. Here, too, the sheet insulating material is cut and drilled. Nearby is the polishing department where the finish-

(Continued on page 272)



The belt-conveyor system brings the assembled sets to inspectors, who give them rigid mechanical and electrical tests.



Radio-Operated Furnace Melts Precious Metals

By S. R. WINTERS

Here is another very practical use to which radio waves have been put; namely, heating a furnace sufficiently to melt the most refractory metals, while the outside is almost cool.



In former issues of RADIO NEWS have often appeared prophecies concerning the uses to which radio waves will be put. One of these has now come to pass; namely that of using radio waves for other purposes than that of transmitting signals from one place to another.

The radio furnace which has recently been installed at the Bureau of Standards is but a forerunner of what may be expected within the next few decades. Who is rash enough to guess what the next step forward will be?—EDITOR.

A STEEL furnace operated by radio, is a phrase that sounds like a fantasy or appears to be a product of the imagination, in the absence of explanatory details. However, when we are told that a high-frequency induction converter is employed in changing 60-cycle house-lighting current into high frequencies, and that these currents are applied in heating a furnace, this descriptive term takes on the form of reality.

Even this explanation does not lessen the wonderment caused by this and similar astonishing uses to which currents of high frequencies or radio waves, are being put. The common acceptance of the term "radio waves" is that invisible energy racing through the ether from a broadcast station to our receiving sets, bearing music, speech, and other forms of entertainment and education. But in this instance we have the novel application of radio waves, or high-frequency current, in supplying heat to a steel furnace for melting precious metals, such as gold and platinum.

A new 1½-kilowatt radio-operated furnace was recently installed in the Metallurgical Division of the Bureau of Standards. The vacuum tubes used in this apparatus are identical in shape, size and characteristics with many of the electron tubes found at any radio broadcast station. That is to say, six 250-watt transmitting tubes are employed, in two parallel rows, three in each row. The 110-volt, 60-cycle electric house-lighting system is the sole source of power, no motor generator or batteries being required.

The 60-cycle electric-lighting current is converted into high-frequencies, on the order of 300,000 cycles; and these again converted into heat are used for the melting of platinum, gold, or other precious metals instead of as a medium for radio signaling. For the production of pure platinum, for instance, this type of furnace is peculiarly fitted; and in meeting the needs for high temperatures little difficulty is experienced in reaching a heat of 3,000 degrees Centigrade.

This furnace, an invention of Dr. Edwin F. Northrup of Princeton University, is capable of heating with marked rapidity. A crucible filled with graphite can be subjected to a temperature of 2,500 degrees Centigrade in a period of less than twenty minutes. Yet, with this degree of heat on the inside of a steel furnace, the temperature on the outside is not likely to exceed 100 degrees Centigrade, a condition contributing to the operator's comfort during the summer months. The capacity of a powerful furnace of this type—when operated by, say, a 20-kilowatt high-

frequency converter—is suggested by its achievement of melting 85 pounds of copper per hour, or between 600 and 700 pounds of this metal in the course of eight hours.

SOURCE OF INTERFERENCE

This high-frequency converter, while charging the steel furnace with electric currents, may produce what the radio amateur terms QRN—interference with the reception of radio communications. This form of interference, is of course, a very recent addition to the already long list of sources which tend to mar the clarity of radio reception—including such causes as trolley cars, arc lights, gasoline engines, violet-ray machines, X-ray machines, and harmonics from radio transmitting stations. The amount of disturbance produced by this radio-operated furnace is a disputed question, some claiming that the amount of QRN is considerable, while others maintain it is a negligible quantity.

Strange to say, the same furnace that is productive of some interference may be employed in increasing the efficiency of the vacuum tubes used in radio receiving sets by broadcast listeners who might voice complaints about the interference caused in the operation of this furnace. Quite recently several large electrical manufacturers were issued licenses to make high-frequency apparatus for the purpose of heating the interior parts of vacuum tubes while gases are being expelled.

Gases in the metal parts of these modern Aladdin's lamps are said to be more readily driven off by this induction method than by applying heat to the electron tubes, during evacuation, by conduction and radiation from filaments heated by the passage of currents. By means of this high-frequency induction furnace electric energy, ordinarily represented as heat losses in many electric furnaces, is converted to a useful purpose. The furnace contains a water-cooled copper coil, carrying high-frequency current, which sur-

rounds a conducting mass wherein eddy currents are induced. The latter are converted into heat and thus use is made of currents, which in some furnaces would represent heat losses.

THE FURNACE APPARATUS

The converter, which transforms the 60-cycle commercial electric current into high frequencies, takes the form of a metal cage. On its face is a switchboard, containing a wheel for controlling the electric power, and an indicating wattmeter.

The three essential units of the converter are enclosed in this cage, namely, condensers, a transformer, and a discharge gap. The latter has two electrodes which are raised and lowered over a surface of mercury held in a metal container. A hand wheel on the face of the switchboard is manipulated for the raising and lowering of the electrodes. The power delivered by this converter may be varied from zero to many kilowatts by changing the distance of these electrodes above the surface of the mercury. The transformer steps the line voltage up to 6,000 volts without danger, since the high-tension parts are enclosed in the metal cage, which is grounded.

The furnace proper, operated by the high-frequency current from the converter, is a box made of asbestos board, approximately cubical in shape, being 16x16x14½ inches in dimensions. This cube-like receptacle contains the inductor coil, the electrical insulation, the small amount of heat-insulating material required, and the crucible in which is deposited the platinum or alloy to be melted. The completed furnace is mounted on a table which is also built of heavy asbestos board. This table is 20x36 inches, at a height of 15 inches. The leads from the high-frequency converter are permanently connected to the metal pieces beneath the cover of the table which form contact with two metal feet at the base of the furnace box.

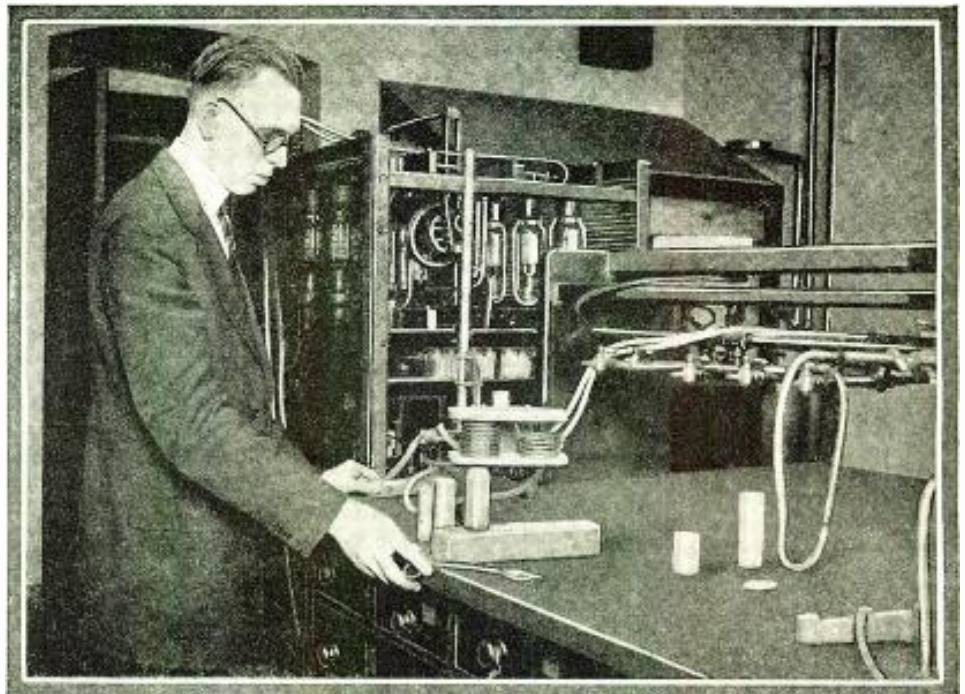

This is a radio-operated furnace that has recently been installed in the Bureau of Standards in Washington, D. C. Louis J. Ordan of the Metallurgical Division is shown operating the furnace. ©Harris & Ewing.

Kits of Parts for the Set Constructor

By M. L. MUHLEMAN

It is a simple matter nowadays for anyone to build or assemble a radio set from the kits of parts made available by the manufacturers. This article outlines a number of various types of kits.



It is interesting to draw a comparison between the radio industry of today and that of but a few years ago. As in every new industry, the time comes when a degree of stability is realized. This is brought about principally by competition; materials reach the stage of standardization, sales and service methods assist in increasing production and, in the end, the industry is settled on a firm foundation.

The early radio industry was a hit-or-miss proposition; no one could foretell the fate of a manufacturer who was, seemingly, thriving. One thing was positive; every company had to be on its toes and in a position to swing from one product to another, as the enthusiasm of the public shifted.

The first legion of radio fans were pioneers of an odd type. It was through their influence that the industry finally and necessarily readjusted itself. As this legion grew—and it grew by leaps and bounds—their de-

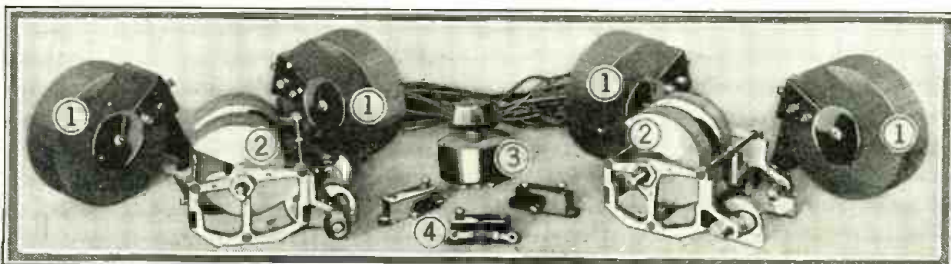

Fig. 2. A kit of parts for a 6-tube neutrodyne set, employing three stages of radio-frequency amplification and having but two controls. The parts are: 1, radio-frequency transformers; 2, tandem variable condensers; 3, stabilizer and 4, neutralizing condensers.
Photo courtesy of Bremer-Tully Mfg. Co.

were eliminated this last season. The manufacturer who has weathered the storm is assured of a steady business, because he has won the faith of the public, who are now more steady in their buying of apparatus than they ever have been before.

Now, let us see what the manufacturer has

companies. Some manufacturers realized it too late, their names being now included in the list of those departed from the industry.

RADIO KITS OF MOST BENEFIT

The radio kits placed on the market have been of most benefit to the radio fan. These have made it a simple matter for any fan to construct his own set, using his pet circuit; and without the necessity, in many cases, of obtaining a great number of tools. Also, the difference in dollars of the costs, of a completely assembled set and that of a complete kit of parts, is not to be sniffed at. It is possible for the fan to build from a kit a set, that when finished, will have all the appearances of a factory-made set, yet at a much lower cost.

Too, there is a certain amount of variability offered, in the case of a kit, as one can change the layout to suit himself, if he cares to do so; he can choose his own cabinet, panel, and in many cases, select the types of variable condensers and audio-frequency amplifier systems most appealing to him. The set, when completed, though it was made from standard parts, contains many of the constructor's own ideas. It is distinctive and need not necessarily be called a duplicate or copy of any other set made from the same type of kit. We know of very few radio fans who fail to receive a great amount of pleasure from building or assembling their own outfits.

There are still a great number, however, who are unfamiliar with the various types of

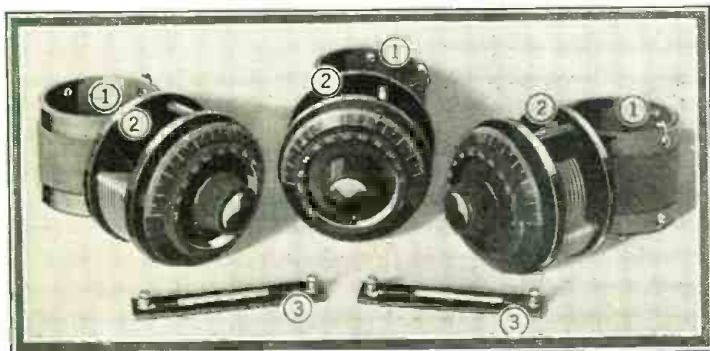

Fig. 1. The parts composing a neutrodyne kit of the five-tube type, these being two stages of tuned-radio-frequency amplification. 1, the neutroformers; 2, the variable condensers; and 3, the neutralizing condensers.

Photo courtesy of The Workrite Manufacturing Co.

mands became more exacting. They wanted, most of them, to build their own sets; and the parts being offered them were far from being satisfactory. They were tired of constructing their own coils for the new circuits which were arriving at the rate of three or four a week. They wanted to build their own sets; but they were not particularly desirous of doing the whole job themselves. But if the manufacturers would make it easy for them, by putting out the special parts required for all the new circuits, the job would be comparatively simple. The manufacturers, not being deaf to the unmistakable call, got busy and put their machinery to new work. All of this proved highly profitable to all concerned.

SET BUILDERS' OUTFITS

Today, we find that the industry makes more out of these special parts than out of the completely manufactured sets. Fans still want to build their own, for they have their own individual ideas as to what a set should look like and what type of circuit should be used.

Competition has become so keen, due to the fact that the productive capacity now exceeds the demand, that a manufacturer, if he is to remain in business, must turn out the best of apparatus and, furthermore, sell it at a moderate price. We find that this competition is most favorable for everybody concerned; the radio public certainly profits by it and so does the manufacturer, because competition has made him straighten out his own business and place it on a firm foundation. The survivors have the pleasure of knowing that there is proved strength behind their organizations, for the weak ones

done for the radio fan. We know that through his efforts apparatus has become more or less standardized. We know it is nowadays of better material, more accurately designed and consequently closer to being fool-proof. Apparatus is no longer made in a hit-or-miss fashion; it is designed by engineers. It took some manufacturers a long time to realize that they required the services of thoroughly-trained radio engineers, if they were to compete successfully with other

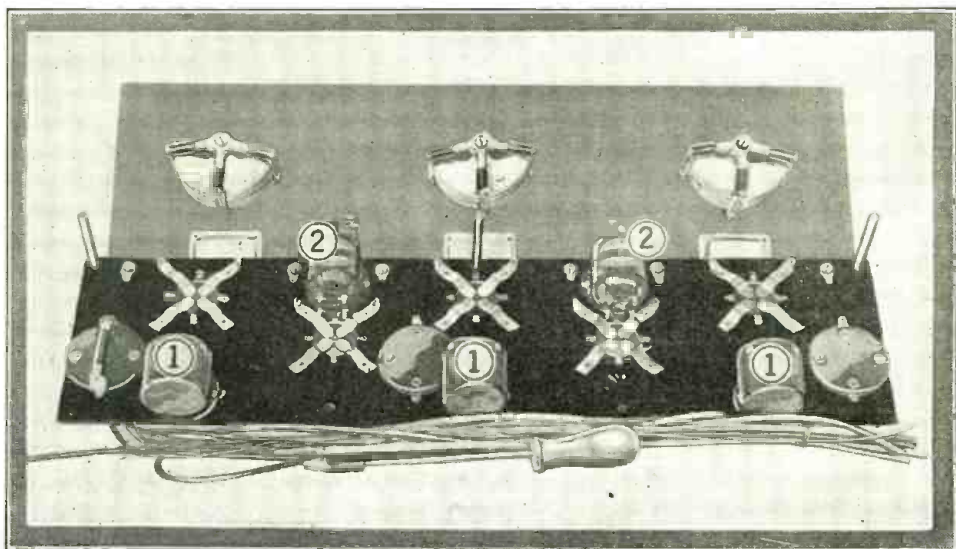

Fig. 3. A five-tube tuned-radio-frequency receiver kit, which comes already assembled. The three variable condensers can be seen mounted on the front panel. 1, the three radio-frequency transformers; 2, the audio-frequency transformers.
Photo courtesy of Premier Electric Company.

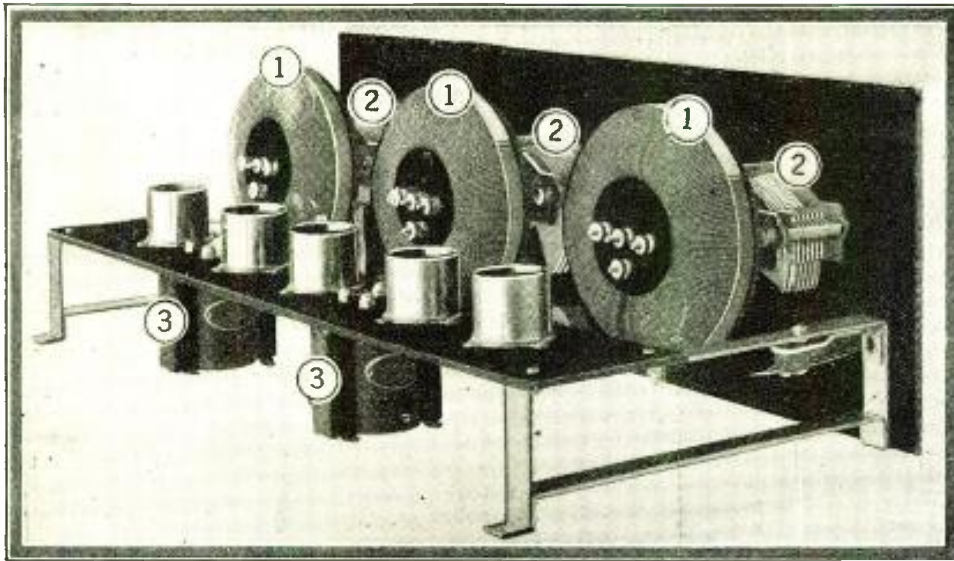

Fig. 5. Another five-tube tuned-radio-frequency set, which comes assembled, but not wired, in kit form. The parts are: 1, radio-frequency transformers; 2, variable condensers; 3, audio-frequency transformers. Note the simplicity of layout.
Photo courtesy of Electrical Research Laboratories

kits on the market at the present time, or who are not acquainted with the form of circuits for which they are made expressly. It is the purpose of this article to outline and classify a number of kits particularly adaptable to present-day requirements as well as to describe in brief the characteristics of each.

A NEUTRODYNE KIT

A kit composing the essential parts of a neutrodyne receiver is illustrated in Fig. 1. There are three variable condensers each with the radio-frequency transformer attached to its rear supports and, in front, two neutralizing condensers, which are employed to prevent the circuit from oscillating; in other words, to stabilize the set.

The usual form of neutrodyne set employs five tubes; there are two stages of neutralized radio-frequency amplification, the detector and two stages of audio-frequency amplification. It is evident, however, that one can do with this kit as he pleases; that is, a three-stage resistance-coupled amplifier may be used or a single transformer-coupled stage in connection with one of the new power amplifiers. The parts readily accommodate themselves to any design the constructor wishes to follow. However, complete instructions are included with this kit for the construction of a five-tube receiver employing a standard-sized cabinet and panel.

The neutrodyne circuit is so well known that nothing need be said relative to its characteristics. Suffice it to say that a receiver of this type is excellent for both local and long-distance reception, it is exceptionally easy to operate and is free from the bothersome squeals manifest from some other types of sets. It is designed for use with an outdoor aerial.

Another neutrodyne kit is shown in Fig. 2. There are four radio-frequency transformers having toroidal windings, four variable condensers, three neutralizing condensers and a volume-control unit. The toroidal windings increase somewhat the efficiency of the transformers by reducing slightly the distributed capacity; but the main advantage of this type of winding lies in the fact that the magnetic field of the coils is restricted to a very small area, thus preventing inter-coupling between the transformers.

It will be noted that tandem variable condensers are used; that is, two condensers are mounted on a single shaft. Hence there are but two principal controls. Small compensating condensers which can be seen on the right-hand sides of the variable condensers, provide a means for matching-up the radio-frequency stages, so that all will be

set at exactly the same wave-length at any identical reading of the two dials. Without these compensating condensers it would be impossible to make up for the discrepancy present between any two variable condensers mounted on a single shaft; and, in consequence, the sensitivity of the set would be greatly reduced.

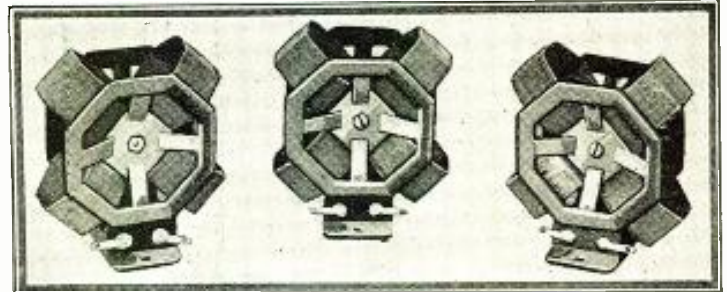

Fig. 4. A set of three radio-frequency transformers with special windings designed particularly for a circuit of the tuned-radio-frequency type.
Photo courtesy of Gearhart Schluter Radio Corp.

Since the parts in this kit make up a set having three stages of radio-frequency amplification, it appears that greater distances can be covered; still, its simplicity of operation is evidenced by the fact that there are but two controls. Any form of audio-frequency amplifier can be used in connection with these parts. Likewise, any sort of layout or cabinet design can be followed.

The kit includes instructions for the building of a six-tube set, using standard sized panel and cabinet.

KITS FOR TUNED-RADIO-FREQUENCY SETS

In Fig. 3 is shown a typical five-tube

tuned-radio-frequency set in kit form. The parts are already mounted on the panel and baseboard, there being very little more to do than the wiring. All of the wires needed for the job are included in the kit, together with a soldering iron.

The three radio-frequency transformers can be seen mounted in the fore part of the sub-base and the two audio-frequency transformers are mounted on the rear of the sub-base. The panel contains the three variable condensers with the filament rheostats directly below them. The radio-frequency transformers in this set are so constructed that there is no possibility of inter-coupling between them.

A set of this type will receive both local and long distance stations and is selective enough for the majority of requirements. Its capability of separating stations on the lower wave-lengths is obtained primarily through the design of the variable condensers; the rotary plates are under-cut, so that the increase in capacity at the lower settings is slow compared to the increase at the upper settings.

This kit is accompanied by very comprehensive instructions for wiring.

The kit shown in the illustration of Fig. 4 includes only the three radio-frequency transformers; leaving the constructor to choose the variable condensers, etc., that appeal most to him.

It will be noted that the windings of these transformers are similar in some respects to the toroids, except that they

are divided into four sections. As in the toroidal coil, the magnetic field is restricted to a comparatively small area. A further advantage is that the high-voltage end of the secondary coil is removed somewhat further from the low-voltage end. Wiring diagrams accompany these transformers, showing how they are to be connected up in various types of tuned-radio-frequency circuits.

Another five-tube tuned-radio-frequency set, constructed from kit parts, is shown in Fig. 5. Again we find in evidence the advantages of which we have already mentioned. The three variable conden-

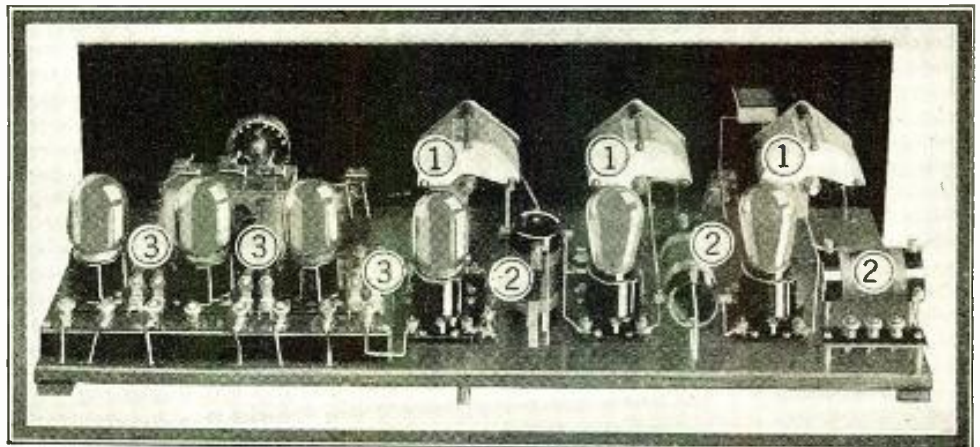

Fig. 6. A six-tube receiver employing a special tuned-radio-frequency circuit. There are two stages of R.F. amplification and three stages of resistance-coupled A.F. amplification. The parts are: 1, variable condensers; 2, R.F. transformers; 3, resistance amplifier units.
Photo courtesy of Daven Radio Corp.

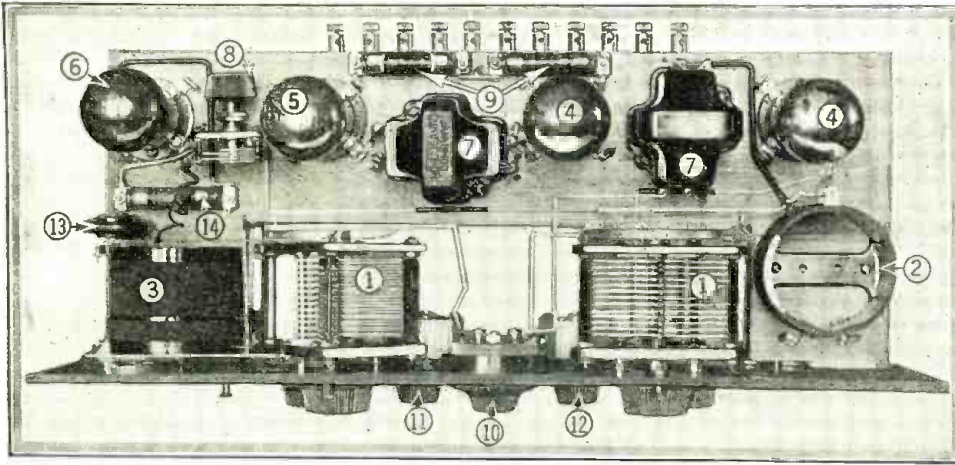

Fig. 7. A set of the regenerative-radio-frequency type, made up from parts which are sold separately. The parts are: 1, variable condensers; 2, R.F. transformers; 3, antenna coupler; 4, audio-frequency tubes; 5, detector tube; 6, R.F. tube; 7, A.F. transformers; 8, compensating condenser; 9, filament controls; 10, variable resistance; 11 and 12, rheostats; 13, grid condenser and 14, grid leak.

sers are mounted on the panel, directly in front of the radio-frequency transformers. The layout is exceptionally neat; the tube sockets are in a straight line on the small sub-base to the rear, and the two audio-frequency transformers are mounted directly beneath the two A.F. tube sockets.

This kit, like the one in Fig. 3, comes assembled; all that is left for the constructor to do is wire up the instruments. This is a very easy job, and there is very little chance of making a mistake, because of the simplicity of the layout and the fact that no connections have to be soldered, since a special type of connector is supplied.

A booklet covering instructions for wiring, and installation as well as methods of trouble shooting accompanies each kit. Like the former types of tuned-radio-frequency sets described, this one is capable of distant reception and is quite selective.

Still another form of radio-frequency kit is shown in Fig. 6. This includes three special types of radio-frequency transformers of the solenoid type. Each primary coil, instead of being wound at one end of the tube as in most cases, is wound first, with the secondary coil directly over it. Consequently, the coupling between the two coils is very close, providing a very large transfer of energy from one to the other. Each transformer has a different primary winding; they are numbered so that no mistake can be made as to their position in the circuit. These transformers are very efficient and, of course, can be used with any type of variable condenser.

These transformers are included with the other parts shown, which compose a three-stage resistance-coupled audio-frequency amplifier; thus, when completed, making a six-tube set. A special type of tuned-radio-frequency circuit is used with these parts; a book of instructions cov-

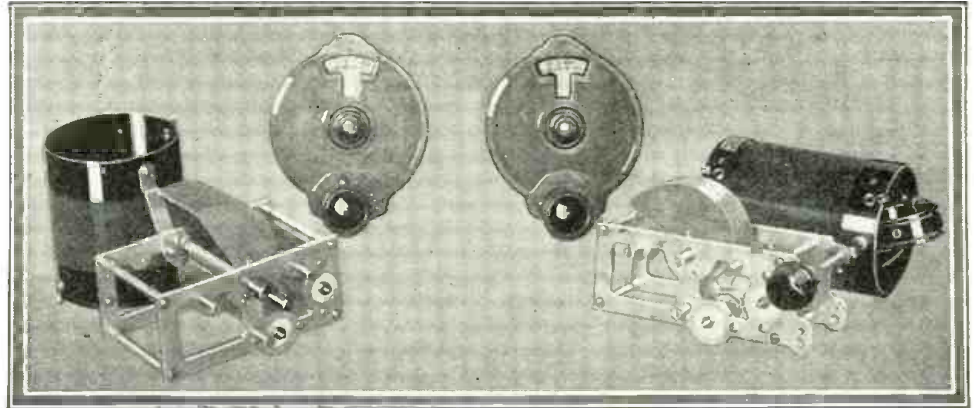

Fig. 8. A kit of parts that can be used for a number of different types of tuned radio frequency circuits. The two dials shown come with the kit.
Photo courtesy of National Company, Inc.

ers the assembly and wiring of the set. The three-stage resistance-coupled amplifier includes the grid and plate resistances and the necessary blocking or isolating condensers. The resistance-coupled amplifier parts, or the three radio-frequency transformers, can be purchased as separate kits by those who want only one or the other.

A set employing these parts contains two stages of radio-frequency amplifica-

tion, with three tuning controls, the detector, and three stages of resistance-coupled audio-frequency amplification. Aside from being able to receive long distance stations, these sets give reproduction of an excellent quality.

REGENERATIVE-RADIO-FREQUENCY KITS

Many circuits have been brought out recently which combine a single stage of tuned-radio-frequency amplification with a regenerative detector. At one time such a combination was thought impossible, insofar as its practical application was concerned; but recent balancing systems which have been developed, when used in conjunction with these circuits, make their operation quite simple. A combination of this sort is extremely sensitive; and when employed with two stages of audio-frequency amplification makes a total of four tubes, giving remarkable results.

The completed receiver shown in Fig. 7 was made up from a kit of parts made expressly for a special type of radio-frequency regenerative circuit. There are two inductance coils; one is a tuned-radio-frequency transformer of the solenoid type, while the other, though similar in appearance and construction, is virtually a coupler, its smaller coil being

employed as a tickler to introduce regeneration in the detector-tube circuit. Two variable condensers tune the two inductances and are the main controls. A small variable balancing condenser is employed for stabilizing the circuit; that is, to prevent it from oscillating. Regeneration, as well as volume, can be controlled by a variable resistance, which is connected in series with the plate circuit of the detector tube.

Any of the parts composing this kit can be purchased separately, as well as a complete book of instructions for building and installing the set.

The essential parts for a similar type of circuit are shown in Fig. 8. In this case, also, there are coils of similar construction fastened to the rear frames of the variable condensers. The unit used in the detector circuit, shown at the right, has a variable tickler, or feed-back coil, which is controlled by a small knob protruding through the front of the panel when the unit is mounted. It will be noted that two vernier dials are included with the kit. These dials, in addition to the usual scale, have spaces for writing in the call letters of the stations received, making it possible to calibrate the set. The circuit in which these parts are used employs four tubes; one a radio-frequency amplifier, another as a regenerative detector, and the last two as audio-frequency amplifiers.

Another kit of parts, employing a re-

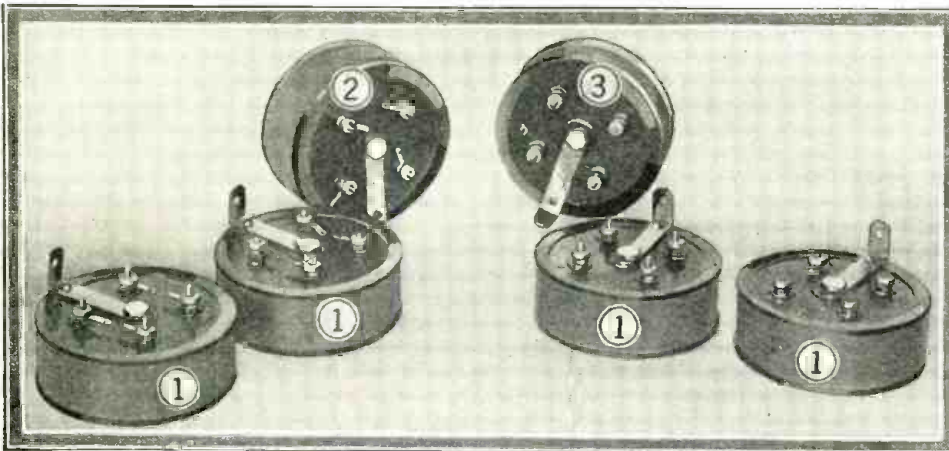

Fig. 12. A kit composing the principal parts for the construction of a Victoreen Super-heterodyne receiver of the six- or eight-tube type: 1, the intermediate-frequency transformers; 2, antenna coupler; 3, the oscillator coupler.
Photo courtesy of The George W. Walker Co.

generative radio-frequency circuit with four tubes, is pictured in Fig. 9. This is one of the most complete kits on the market at the present time, everything except a cabinet being included for the building of the set. The panel is of standard size; so there will be no difficulty in obtaining a cabinet to fit.

Unlike the four-tube kits previously described, this has but a single control. Both the variable condensers, which are of the straight-line-frequency type, are so constructed that they can be coupled together, one behind the other, and the relative positions of the rotor plates adjusted until both tuned circuits are synchronized. A small variable balancing condenser is also employed.

Another feature of this kit is the coils, which are of the plug-in type and can be obtained in many different sizes to cover a wide band of wave-lengths. The coils fit into special sockets.

A booklet of instructions accompanies each kit; all details of the circuit and the assembly of the set are included.

A somewhat similar type of four-tube regenerative radio-frequency kit is shown in Fig. 10; this has two main tuning controls, a stabilizer or balancing condenser,

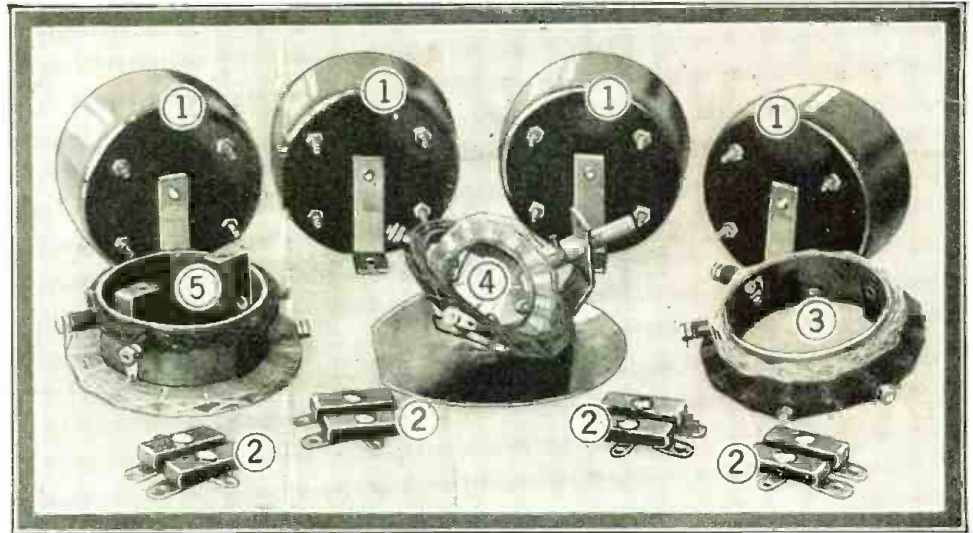

Fig. 11. The kit of parts for the Ultradyne receiver, a form of super-heterodyne. These can be adapted to a six- or an eight-tube set. The parts are: 1. Ultraformers (intermediate-frequency transformers); 2. the fixed condensers employed in conjunction with the Ultraformers; 3, oscillator coupler; 4, regenerative coupler; 5, antenna coupler.

be employed. This set is designed to operate from either an outdoor or a loop

aerial. In both cases long-distance reception is possible.

Another kit of parts for a super-heterodyne set is shown in Fig. 12. This kit is composed of four intermediate-frequency amplifying transformers, an oscillator coil, and an aerial tuning coil. The condensers employed in connection with the secondary windings of the intermediate-frequency transformers are mounted inside the cases. By means of a small nut on the cover of each, it is possible to adjust the capacity of the condensers and so match up all four transformers; that is, adjust them all to the same wave-length. However, these transformers are adjusted before leaving the factory, so that in most cases there will be no necessity for touching them. These parts can be used in conjunction with any components the builder may wish.

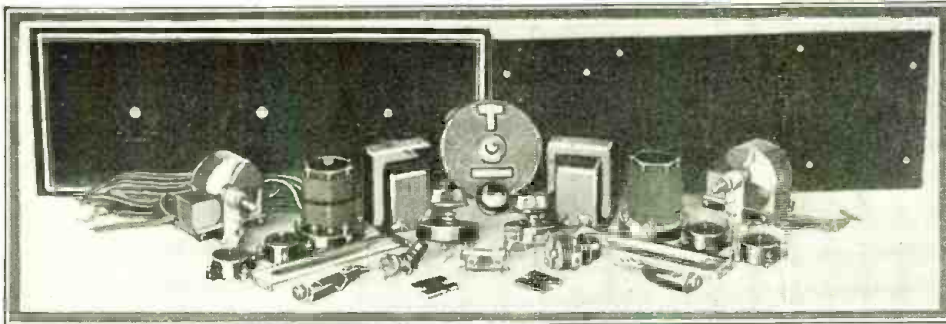

Fig. 9. The complete kit of parts for the Silver-Cockaday receiver, a four-tube regenerative-radio-frequency set employing plug-in coils to cover long and short wave-length bands. The two variable condensers, when installed, are operated in tandem so that there is but a single tuning control.

Photo courtesy of Silver-Marshall, Inc.

and a volume control. This kit of parts is also complete with the exception of the cabinet. However, special cabinets are made expressly for this circuit and may be purchased separately. It will be noted from the view that the set is of the sloping-panel type.

The tickler feed-back type of regeneration is employed in this circuit; the small adjustable coil can be seen in the illustration.

SUPER-HETERODYNE KITS

A super-heterodyne kit is shown in Fig. 11. All essential parts are included: the four intermediate-frequency amplifying transformers, the four matched fixed condensers which are used in conjunction with them, the oscillator coupler, at the right, the regenerative coupler, which is employed in the circuit of the frequency-changer tube, and the aerial tuning coupler. Complete instructions accompany each kit. Though a standard layout for the apparatus is given in the instruction booklet, one may easily follow his own wishes in respect to design. No difficulties are to be encountered, so long as sufficient space is given the various components and the intermediate-frequency transformers are mounted at right angles to each other.

A set made from this kit of parts employs eight tubes: there is an oscillator, a frequency changer, three intermediate-frequency tubes, a detector and two audio-frequency amplifiers. Of course, the audio-frequency amplifier can be dispensed with, or an amplifier of the impedance- or resistance-coupled type can

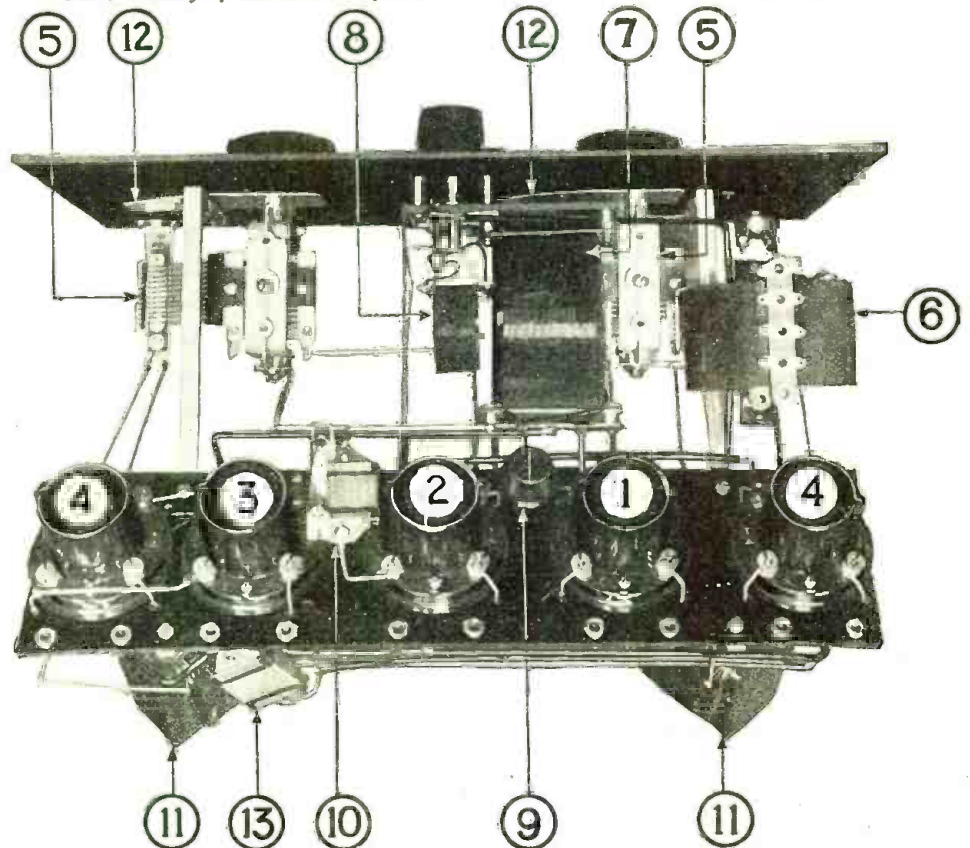
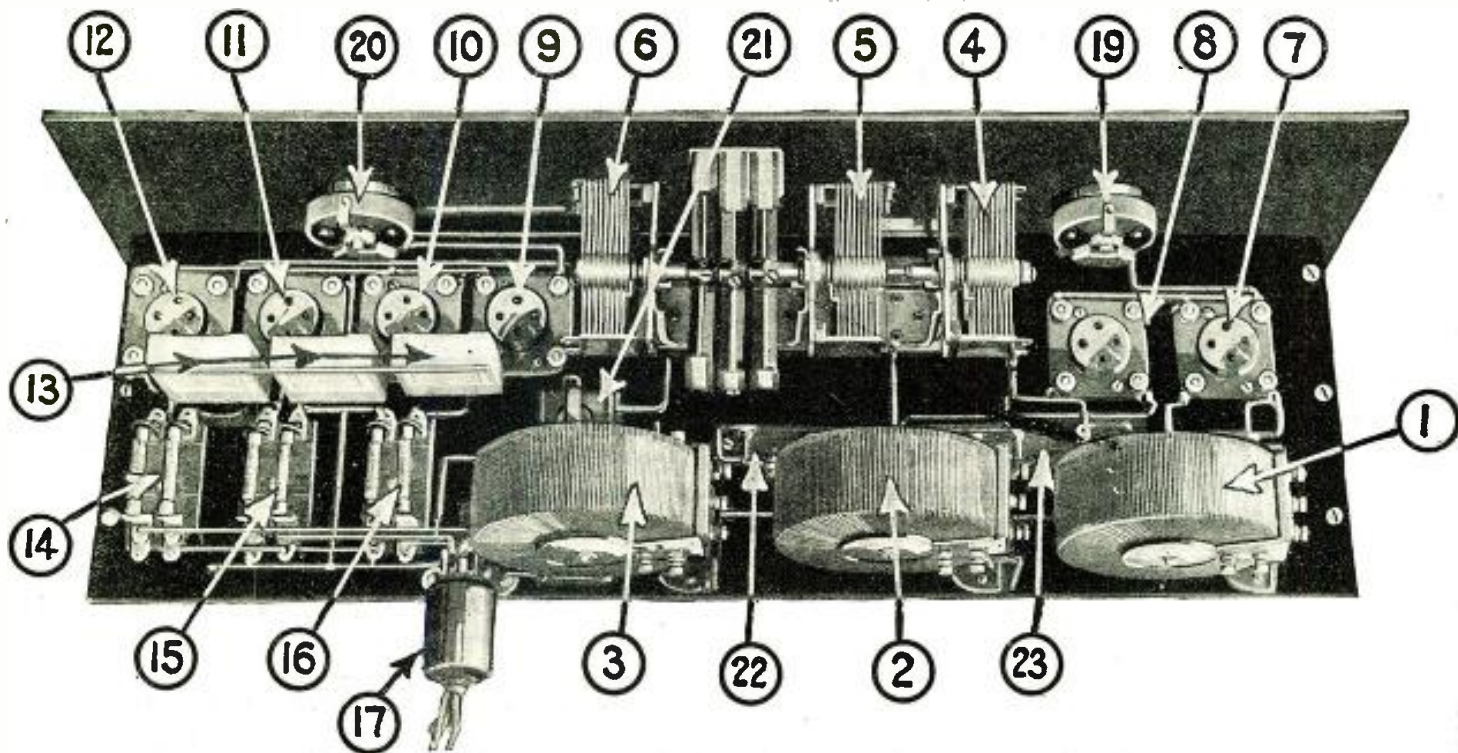

Fig. 10. A Hammarlund-Roberts receiver; of the regenerative-radio-frequency type, made from the complete kit of parts. No. 1 is the R.F. tube socket; 2, detector tube socket; 3 and 4, A.F. amplifier tube sockets; 5, variable condensers; 6, antenna coupler; 7, R.F. transformer; 8, tickler coil; 9, neutralizing condenser; 10, grid leak and condenser; 11, A.F. transformers; 12, shielding; 13, by-pass condenser.



Interior view of the Eusonic Receiver, as constructed in the RADIO NEWS Laboratories, showing the position of the parts, the symmetry of the layout and the general neatness of the entire assembly. The resistance-coupled audio amplifier is conveniently arranged with regard to the A.F. tube sockets. Values of the parts used will be found on the picture wiring diagram opposite, which is similarly numbered.



The Eusonic Receiver

By JOSEPH BERNSLEY



THERE are many constructors who derive a great deal of pleasure from continually experimenting with new circuits and devices, and radio "stuntings." However, there comes a time (we are not getting pessimistic) when familiarity with one particular hobby makes one feel like climbing out of the rut, and trying something else for a change. The following description of a receiver which has nothing surprisingly unique, but nevertheless is capable of giving consistent and efficient results, is offered to the constructor who is always experimenting with various new circuit arrangements, but nevertheless would like to build a receiver for continuous or family use. In other words, it is a receiver that

- which result in a quiet-operating receiver.
- 2.—Toroid coils for inductances, which help to properly neutralize the set, prevent any possibility of magnetic feed-back, and thus serve to keep the receiver in a non-oscillating condition. The prevention of "pick-up" possibility thus serves to increase the selectivity of the set.
- 3.—Special condenser unit, which permits tuning all three tuned stages simultaneously, or separately if desired.
- 4.—Three stages of resistance-coupled audio amplification, resulting in an extraordinary quality which can be safely said to approximate, in faithfulness of tones, the phonograph.
- 5.—Power tube in last stage, which per-

ity and sensitivity of the neutrodyne receiver, will have an approximate idea of the efficiency of the Eusonic set. Rather than design a new circuit, or attempt to, we have obtained standard radio merchandise from various local radio dealers, and built a receiver from the standpoint of the highest possible electrical and mechanical efficiency. Within a very short distance from two 1,000-watt stations (only a quarter of a mile from each) we were able with this set to cut through both, and obtain any of the twenty other local broadcast stations in New York City; and even to reach out during ordinary broadcast hours and obtain a station in Philadelphia, one in Boston, and another in Chicago, all in an evening's entertainment. This, we think, is pretty good for summer reception in the city.

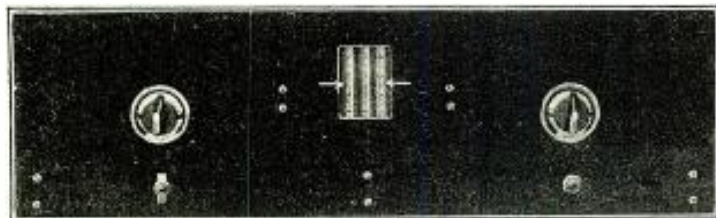

Front view of the Eusonic receiver. Note the simplicity. The vertical scales of the three-in-one control of the three tuned circuits are read between the arrows. All may be varied synchronously. The knobs control the rheostats.

Constructors should endeavor to use exactly similar parts to those employed in this receiver; otherwise difference in design, layout or even efficiency of the receiver may be expected. Toroid coils cannot be "home-made," that is, not very neatly, nor entirely correct. It is best in the long run to purchase them, and for that reason we are omitting specifications. Also, it is not entirely essential that the triple-gang condenser unit we employed, be used. Any single-control triple condenser should perform satisfactorily; although best result will be obtained with a type of control that provides for a slight variation in each unit, to compensate for any differences that might exist in each tuned circuit.

WIRING THE SET

Before the Eusonic set will work to complete satisfaction, it is necessary to adjust the neutralizing or balancing condensers so that the radio-frequency circuits cannot os-

will be always dependable, especially when the new trick circuit has failed to come up to expectations, and company is to be entertained. From this the reader should by no means infer that the receiver is an "old timer." The illustrations of the "Eusonic" receiver will serve to dispel any hallucinations along that line. The following modern devices which are favorites with every radio set user, constructor and engineer, have been incorporated in this set:

- 1.—Two stages of tuned-radio-frequency amplification, neutralized (Hazeltine method) to prevent any whistling or squealing noises,

mits increased amplification without the usual possibility of distortion.

- 6.—Modern design employed in construction of the receiver.

SPECIAL SELECTIVE PERFORMANCE

"Well, what can the set do? Has it unusual possibilities?" are the questions which we can imagine the reader asking. Remember, we have not designed a new circuit; inasmuch as there has been no new or entirely original circuit offered to the public for the past three or four years. Those who are aware of the extraordinary selectiv-

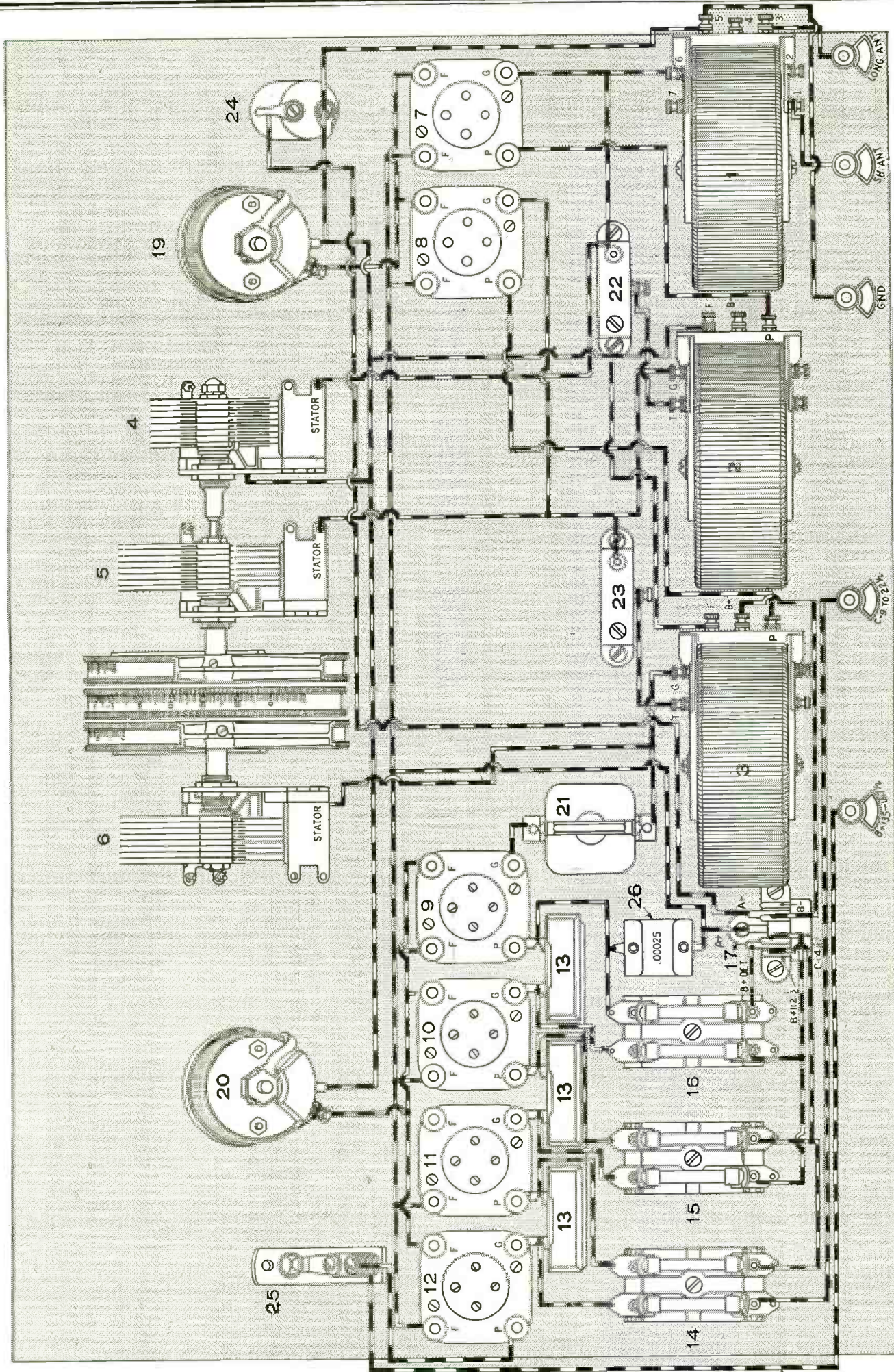

This picture wiring diagram shows the parts of the Eusonic Receiver and their connections. The toroid antenna and R.F. coils are designated by 1, 2 and 3; the three .00035- μ f. condenser units, 4, 5 and 6, are controlled by the vertical dials shown in the center. 7 is the first R.F. socket; 8 the second; 9 is the detector socket; 10, the first A.F. socket, 11 the second, 12 the third. 13 indicates the three one- μ f. by-pass condensers; 14, 15 and 16 are respectively the third, second and first stage resistor coupling units. 17 is the contact connection of the multi-plug battery cable; 19 the 10-ohm R.F. filament rheostat; 20 the 6-ohm detector and A.F. filament rheostat; 21 is the grid-leak and condenser; and 22 and 23 are the balancing or neutralizing condensers.

This picture wiring diagram shows the parts of the Eusonic Receiver and their connections. The toroid antenna and R.F. coils are designated by 1, 2 and 3; the three .00035- μ f. condenser units, 4, 5 and 6, are controlled by the vertical dials shown in the center. 7 is the first R.F. socket; 8 the second; 9 is the detector socket; 10, the first A.F. socket, 11 the second, 12 the third. 13 indicates the three one- μ f. by-pass condensers; 14, 15 and 16 are respectively the third, second and first stage resistor coupling units. 17 is the contact connection of the multi-plug battery cable; 19 the 10-ohm R.F. filament rheostat; 20 the 6-ohm detector and A.F. filament rheostat; 21 is the grid-leak and condenser; and 22 and 23 are the balancing or neutralizing condensers.

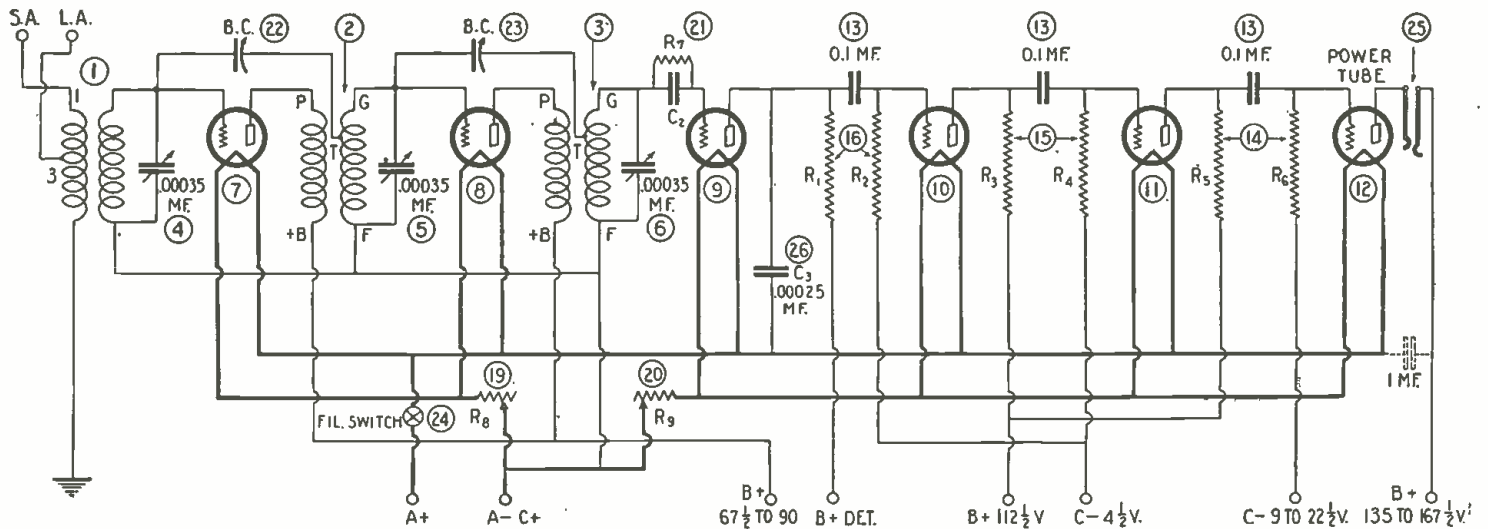

Schematic wiring diagram of the Eusonic receiver, numbered to correspond with the illustrations. Two stages of tuned neutralized R.F. amplification, detector, and three stages of resistance-coupled A.F. amplification, will be seen at a glance. The combination will reproduce the full range of tones in an unusually faithful and pleasing manner.

cillate. Carefully connect up the "A" and "B" batteries to the multi-plug cable. The following is the color scheme employed in the original receiver, and which it is advisable that the constructor duplicate.

Red, "A +"; Green, "A - and C +"; Brown, "B +"; 90 volts, A.F. and R.F.; Black, "B -"; Pink, "B +"; detector, 45 volts; Yellow, "C -"; 4½ volts; Blue, 135 volts, 180 volts. Four binding posts in addition to the cable are necessary; two for antenna and ground, one for "B +"; 135 to 180 volts for the power tube, and one for "C -"; 9 to 22½ volts, also for the power tube. The voltages necessary for the plate and grid of the power tube are dependent upon the type of tube that is to be employed. A UX-112 or -171 is suggested, and five UX-201A's or 301A's for the remaining stages. The proper plate and grid voltages, and other tube characteristics of present popular types, with additional information, will be found in the article "All About Vacuum Tubes" in the August, 1926, issue of RADIO NEWS.

To determine whether there is any possibility of burning out the tubes, due to incorrect wiring or some short circuit, in making the initial test, we suggest that the "A" battery be connected to the "B -" and "B +"; amplifier leads from the cable plug. If the tubes light, with only this battery connection made, then do not go any further without locating and remedying the trouble. The tubes should light only when the "A" battery is connected to the "A" battery leads.

There are two practical methods of neutralizing or balancing this receiver. The first, although very simple, but not as effective as the second, is as follows:

BALANCING THE SET

After connecting the "A" and "B" batteries to their respective colored wires and terminals, insert the vacuum tubes in the sockets, and light them to normal brilliancy. Now rotate all three condenser dials in step with each other and note whether the circuit oscillates. This can be determined by a plucking or clicking noise in the headphones. When such a point on the dial settings is found, stop; and increase the capacity of both neutralizing condensers. This procedure should be continued until the circuit will not oscillate at any of the dial settings.

The second method preferably employs some form of "circuit driver," which may consist of a buzzer, a battery, a variable condenser and a coil consisting of about 50 turns of wire on a 3-inch cardboard tube. It is connected as shown in Fig. 2, and a wire run from one end of the coil to the antenna binding post on the Eusonic receiver. Set the dial of the variable condenser in the circuit driver at about 20 to 25 degrees, start the buzzer, and then light the vacuum tubes in the set as before. All the three condenser controls in the receiver should be then adjusted until the buzz from the circuit driver is heard the loudest. It will be found that the controls will have about the same setting. Next remove the first amplifier tube from its socket, and again adjust the three dials for the loudest buzz.

A small piece of paper should now be placed over one of the filament prongs of the vacuum tube that has been removed, so that it cannot make contact with the respective prong of the tube socket. The tube is then put back into place. The filament, of course,

will not light, since the small piece of paper has broken the connection.

It will at once be noticed upon replacing this tube that the buzz from the circuit driver can still be heard, but is much weaker than before. The next step is to adjust the first balancing condenser until the buzz becomes very weak, or entirely disappears. On taking the tube out again, the buzz will

PARTS FOR THE "EUSONIC" SET

- 3 Toroid Coils of a type which makes provision for neutralization; that is, besides the usual four terminals for primary and secondary windings, also provides a neutralizing tap;
 - 1 Triple-Gang Condenser, .00035- μ f. for each unit,
 - 6 UX Sockets, preferably of the spring or cushion type;
 - 1 6-ohm Rheostat (R9);
 - 1 10-ohm Rheostat (R8);
 - 3 By-Pass Condensers, 0.1- μ f.;
 - 1 Grid Condenser, .00025- μ f., with grid-leak mounting (C2);
 - 2 Midget Variable Condensers, for balancing or neutralization;
 - 1 Grid Leak, 2-megohm (R7);
 - 1 Single-Circuit Jack;
 - 2 Resistors, 1-Megohm (R2 and R4);
 - 3 Resistors, 0.1-Megohm (R1, R3, and R5);
 - 1 Resistor, .25-Megohm (R6);
 - 1 Bakelite Panel, 7x24 inches;
 - 1 Sub-Base Panel, 7x23 inches; either bakelite or hard rubber;
 - 3 Brackets;
 - 1 Multi-Plug Cable;
 - Miscellaneous, such as spaghetti, bus-bar, assortment of screws, nuts, etc.
- Approximate cost, \$45.00.

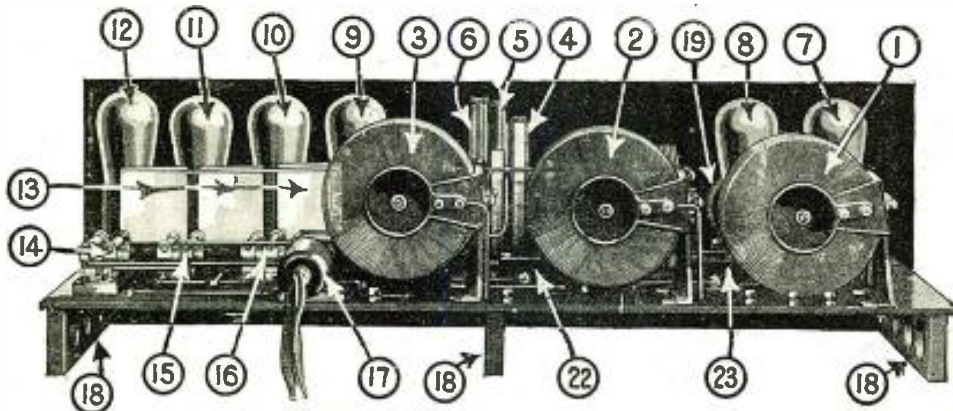

Rear view of the Eusonic receiver, showing the toroidal R.F. inductances, and the mounting of the system on a sub-base panel supported by three shelf brackets (Nos. 18).

be heard loudly, and on replacing it this becomes very weak or disappears. This covers the adjustment of the first amplifier circuit. The second amplifier circuit is adjusted in the same manner, with all the vacuum tubes in place and lit, including the first one: except that the piece of paper this time is placed over the filament prong of the second tube. Remember that the adjustments made remain only while using those tubes. If other vacuum tubes are put in, or tubes interchanged, the two radio-frequency circuits will have to be adjusted again.

(Continued on page 307)

How to Build Wireless Receivers

By EDMUND T. FLEWELLING



In this article, the fifth of this series, Mr. Flewelling gives further details about the use of his connection strip in assembling receivers of various types practically without the use of any wire.

CLOSING this series concerning radio receivers built with a minimum amount of wire for connecting the various component parts, this article is illustrated by views of an 8-tube super-heterodyne and a 5-tube tuned-radio-frequency receiver, both of the usual type. Both receivers, however, exhibit the same departure from general practice, in that they are constructed practically without any wires, are shielded, and have been constructed and reconstructed several times to ascertain how the use of different parts would work out. The receivers are in actual operation and

ing how quickly the receiver can be assembled and put in operation. The receiver, as shown, was built in less than one hour after the panels were drilled. Ten to fifteen minutes for the complete job on either the super-het or the 5-tube set would be slow time for production work; assuming of course that coils and transformers were ready for assembly.

FLEXIBILITY OF HOOK-UPS

In this super-het each detector tube is operated by a separate rheostat and the three intermediate tubes operate from the third

and in their proper location. If this location is not suitable another may be chosen. So versatile in fact is the arrangement that we are being surprised every day by some new possible combination that is as plain as the nose on one's face—after he sees it.

Did you ever stop to think how logical is this location for the terminals of transformers of R.F. or A.F. types?



I mean this for any method of construction that you care to consider. Receivers cannot wire themselves but they will go a long, long way toward it if one but gives them an opportunity.

Figs. 2 and 3 are the rear and bottom views of the 5-tube receiver with the shields removed. This receiver again shows the same versatility in the type of construction, and the same duplication of results. All parts can be, if desired, located in a variety of ways for panel-spacing, shielding, etc. Note the long leads and right-angle turns in the wiring. Consider the small R.F. transformers. Inasmuch as our next article is to be upon the subject of radio-frequency amplification, we will have more to say of them at that time. All three condensers in this receiver are operated by a group control, located on the middle condenser, and have individual verniers. One rheostat operates the detector tube, one controls the two R.F. tubes and the amplifiers are controlled by automatic resistances.

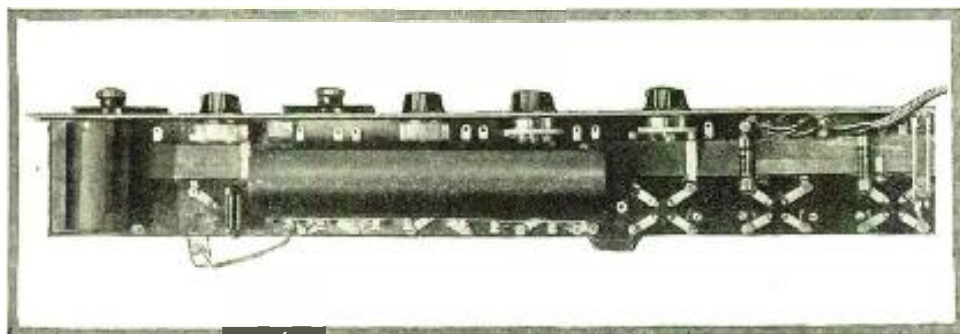

Fig. 1. Oscillator coil and I.F. transformer terminals are spaced the same as socket terminals. When this condition is met, need for wires is automatically abolished. Note battery cable; terminals for this may be found throughout length of receiver. Entire receiver contains 6 inches of wire, most of which may be seen from grid condenser.

have proven to be the best receivers that the writer has ever operated. So certain are the results from this type of construction that he would do a large amount of hesitating before returning to hay-wire receivers again. All patent rights, again, are reserved by the writer of this article.

Consider for a moment Fig. 1, which shows the bottom of the 8-tube super. This receiver has been constructed and operated with four different makes of rheostats, four different makes of intermediate transformers, three different audio transformers; and, had the material been available, probably a dozen other combinations could have been used, with but slight effect upon the amount of wire needed. At no time has a total of more than 6 inches of wire been used in the entire outfit.

Separate units for intermediate transformers are much easier to handle than the multiple unit shown, more especially if their terminals are somewhere near the correct position. Given units that are built for use in this type of design, it is perfectly surpris-

rheostat. Amplifier and oscillator tubes are controlled by automatic filament resistances. Within reasonable limits, transformers, rheostats, condensers, filament controls, potenti-

Fig. 2. Note the free spaces between stages for shielding. Note the short condenser connections, to grid side. The variable condensers, rheostats, switches or meters may be spaced with large variations, as desired.

Photos courtesy Kurz-Kasch Co.

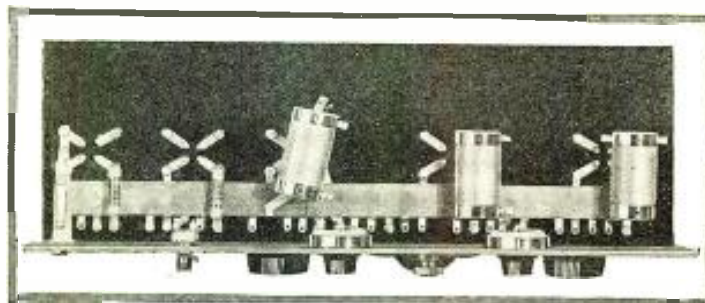

meters, etc., may be mounted either above or beneath the sub-panel; and this applies to transformer, resistance, or impedance types of receivers. Terminals for filament switch, battery cable, meters, jacks, etc., are available

The objection may be raised to this type of construction, that one would be limited in the kind of hook-up or type of apparatus that he must use, and that therefore its use would tend to narrow the experimenter's field. That this is not at all true is shown by the illustration of two entirely different types of hook-up; and could be further demonstrated if space permitted, by illustrating receivers using any known type of hook-up and various kinds of component parts. If we were fortunate enough to have a few keen radio engineers, experimenters, etc., working with such construction, the possibilities, to the writer, would seem to be absolutely unlimited.

He has described this method in the belief that it has merit, and with a sincere hope that his readers may receive some value from a study of its possibilities as they have been outlined.

(NOTE—Illustrations showing the details of the connecting "capacity strip" invented by Mr. Flewelling appear on page 141 of RADIO NEWS for August.—Editor.)

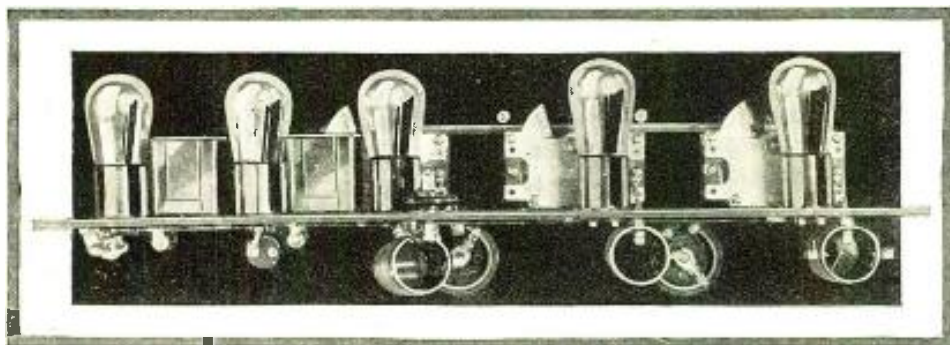

Fig. 3. Note the lack of wiring; for the jack, ballasts, audio and R.F. transformers, rheostats, filament switch and variable condensers fit to proper tabs from strip. Any combination of tabs may be used, within limits.

A Family Receiver

By WATSON BROWN

One of the greatest needs in radio is a set that has one control and in which the adjustments are automatic. Such receivers are generally difficult to construct; but Mr. Brown here presents one which can be built by almost any constructor, and as it may be seen there is but one control.

THE receiver described here is easier for the average fan to build than almost any single-control receiver that works equally well over the entire broadcast wave-range. The parts used are easily bought and made, and the hook-up used is a safe and proven one. Only one dial appears on the panel; it controls the filament switch, does the tuning and turns a cam which automatically adjusts the tickler. The parts used are "low loss" and

No. 26 D.C. wire. The large number of turns makes only a slight rotation necessary in the tickler coil, to get the correct tickler coupling for any broadcast wavelength. When the leverage supplied by the wire which rests on the cam is taken into consideration, it will be seen that the shortness of movement is very desirable.

Primary, secondary and tickler should be coated with one of the good moisture-proof coatings now on the market. It's true that this coating gives the coils a slightly-greater capacity; but it also keeps them from absorbing moisture in damp weather, which changes the working condition of the set, a thing to be avoided.

The tickler coil is sewed tightly to its shaft, which is a strip of insulating material (it may be sawed from a panel), sharpened like a pencil at each end and drilled for the bent wire, whose other end rests on the cam. The way that the shaft is pivoted between upright metal supports will best be understood from the picture. The thing to keep uppermost in mind, while making this arrangement, is to build it so that the tickler coupling can be varied with very little force, that gravity holds one end of the bent wire lightly against the cam, and that none of the parts can be moved except when tuning the set.

to hold the cam securely, but the latter can be taken off and replaced readily; this is easily done with three screws. Switch points may be used and a drilled 3/4-inch metal disc, as shown in the drawing.

FILAMENT SWITCH AND BALLAST

The automatic filament switch is not a necessary part for this set. It is easy to make, though, and it works fine. It saves a control from the panel; and as the broadcast station on the lowest wave-length comes

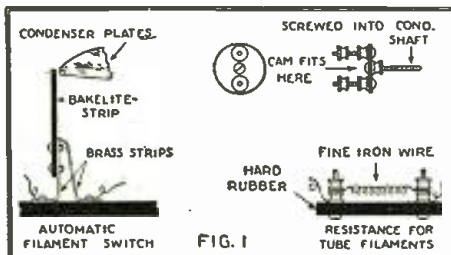

These diagrams will aid the builder in constructing the switch, the cam holder and the automatic filament adjustment.

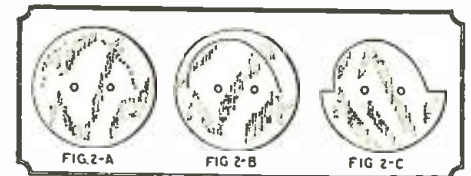

Fig. 2A shows the dents made in the cam; 2B shows a line connecting these dots. When this part of the cam is cut, the result is shown in 2C.

in on 15 while the filament current is cut off at 9, nothing is missed through its use.

The resistance for the filament circuit consists of a fine iron wire, coiled spring-fashion, and stretched between two binding posts. When the battery is strong the fine wire heats more than usual and adds more resistance to the circuit, so that the filament circuit there is to a slight degree an automatic rheostat. For four 201-A tubes, about twelve inches of iron wire from an ordinary window screen serves very well; though a shorter piece of smaller wire is more "automatic."

The first two transformers are of 3-to-1 ratio while the third one is of 2-to-1 ratio. In the set pictured no howl of any kind developed. A transformer howl can always be stopped by shunting fixed condensers or grid leaks across one or more of the secondaries of the transformers. The hook-up shows the negative filament post on the transformers connected to the battery side of the filament resistance. This gives a higher negative potential on the grids.

When connecting the parts of the set, if the tickler and secondary coils are wound in the same direction and the top lead of the secondary goes to the grid condenser, then the bottom lead of the tickler coil goes to the plate. Otherwise the set will not regenerate.

CONSTRUCTING A TUNING CAM

The set is connected to the aerial and ground that are to be used, the tubes are placed in their sockets, the "B" battery voltage made right and the grid leak put in place. Tuning is then done by moving the dial with one hand, and the stiff wire which controls the tickler with the other. Be certain that the receiver is working just right before making the cam. Tune in the station on the wave-length that requires the greatest tickler coupling; work out the tickler coupling so that the signal comes in best without the whistle. Then, holding the tickler shaft in place with pliers, bend the stiff wire so that it nearly touches the edge of the 3/4-inch metal disc.

The station on the wave-length which requires the loosest coupling is then tuned-in; and the tickler is adjusted where the signal is best without the whistle. The distance from the part of the wire that is to rest

the condenser is of the straight-line-frequency type. The mechanical arrangement (cam) used for the tickler control permits all the desirable volume, sharpness and sensitivity of regeneration, but reduces the controls to one, and at the same time eliminates the annoying station whistle. This, with the great volume derived from the three stages of audio frequency amplification, go to make it a desirable family receiver.

The primary, or antenna, coil consists of fourteen turns. More than this number will give slightly greater signal strength, but also broaden the tuning; while fewer turns will sharpen the tuning. The secondary is a 55-turn extension of the primary, the coil containing in all 69 turns. Primary and secondary are of No. 18 D.C. wire (bell wire) in the set described.

The tickler coil is smaller than the other, as it must revolve within the primary and secondary coil. It consists of 60 turns of



The Family Receiver has one control on the panel, which switches on the filaments and tunes the set.

There are on the market straight-line-frequency condensers which have the inside ends of their shafts drilled and threaded. The set described makes use of such a condenser, for the automatic tickler control is screwed to this threaded shaft. The attachment to the condenser shaft is such as

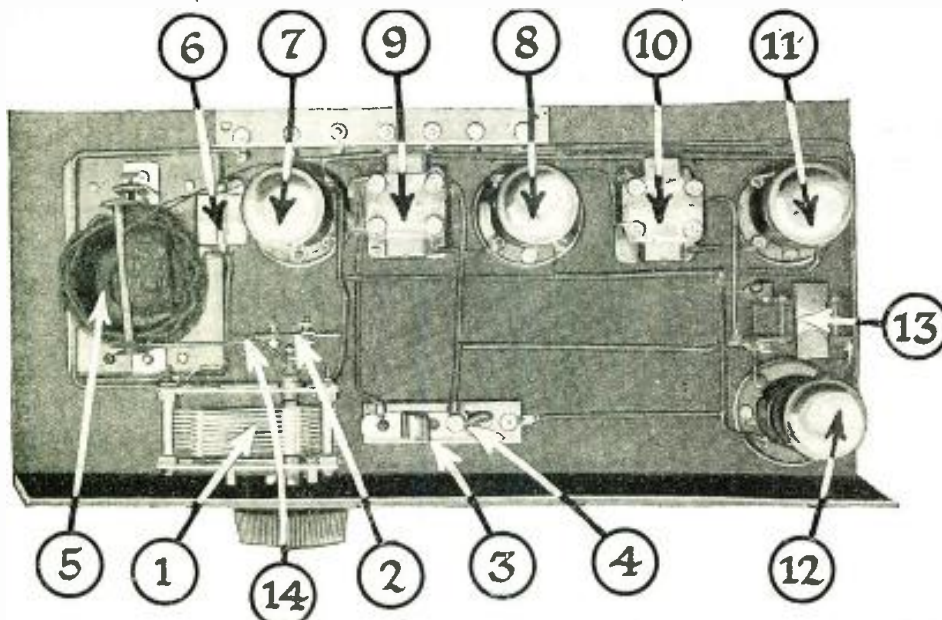

No. 1 is the S.L.F. condenser; 2, the tickler cam; 3, filament switch; 4, automatic filament resistance; 5, inductance coils; 6, grid condenser and leak; 7, detector tube; 8, 11 and 12, A. F. amplifier tubes; 9, 10 and 13, A.F. transformers; 14, wire resting on cam.

A New Idea In Set Construction

By JOSEPH RILEY

Introducing to the readers of RADIO NEWS a new idea in the construction and wiring of a radio receiver. This is a really simplified, all-panel-mounted, shielded and easily built four-tube set.



RADIO NEWS once more leads the field with a new and practical idea in receiver construction for radio enthusiasts: the first set having all its component parts mounted on a panel has been developed in the RADIO NEWS Laboratories. Mr. Sylvan Harris, the originator of the idea, believes firmly that this is a step in the right direction—increased compactness and portability—and for that reason we are glad to present our readers with complete details. "Everything on the panel" should become a national slogan in radio construction. Furthermore, to utilize every part for all that is in it, and to eliminate everything unnecessary, use the metal panel itself as a conductor, and eliminate half or more of the wiring.

BEFORE undertaking the construction of a receiver which will satisfactorily meet every need of the broadcast listener, it is necessary to consider carefully just what guiding principles there are to follow.

The very first consideration is the circuit to be employed. Not more than two controls are desirable. One stage of tuned radio frequency and a non-regenerative detector will give good results if properly designed. Then again, two stages of transformer-coupled audio frequency amplification afford all the volume necessary. The circuit is thus decided on: and there remains the question of suitable design and construction, to minimize the number of unnecessary parts, and cut out all unnecessary complexity and labor. The question arises: "Why not use the metal panel itself as a conductor?"

PREPARATION FOR BUILDING THE SET

A careful survey of the plan outlined above was enough to show its feasibility and an aluminum panel, 7x24x $\frac{1}{8}$ -inch, was secured. This panel acts as the "A—" lead in this receiver. It was first carefully sanded and given a slight bevel to remove any burrs, and then coated with black enamel. (It may be streaked or grained to suit the constructor's taste.) On this panel were arranged, in the best manner possible, four sockets, two .0005- μ f. straight-line-frequency variable condensers, one filament switch, one 400-ohm variable resistance, one output jack, and four filament-resistance holders. Care was exercised in placing the sockets so that the planes of the filaments in the horizontally-mounted tubes should be perpendicular. Those who are disquieted at the sight of a tube mounted horizontally will find that there is nothing wrong in mounting it in this manner, if carefully done (in fact, one of the leading manufacturers of radio equipment mounts the tubes used in speech-control and amplifier units in just this manner.)

The rest of the apparatus necessary for the complete construction of this receiver included the two R.F. and two A.F. transformers, one grid-leak and grid-condenser, and an assortment of fibre washers with which to insulate the various parts.

COIL CONSTRUCTION

The radio frequency transformers consist of a secondary winding of 59 turns of No. 22 D.S.C. wire on a form $2\frac{3}{4}$ inches in diameter, and a primary winding of 15 turns of the same size wire, wound upon one end of the secondary winding, directly over two or three layers of insulating paper placed at that end of the coil.

It will be noted that the ratio between the primary and secondary windings has been made low; in other words, the primary contains almost half again as many turns as are ordinarily used in sets of this character. This results in increased coupling between stages, with consequent enhanced regeneration. The circuit is thus made more sensitive

and selective; but it will be found essential to include a variable resistance in the grid return of the first tube, to give control and prevent self-oscillation. The disadvantages of inductive and capacitive feed-back are eliminated and a better arrangement substituted.

The distinctive feature of this receiver, however, is not the circuit, but the method of assembly. We feel that it is not always necessary to follow the beaten path; but that new and valuable ideas may sometimes lead us into untrodden ways.

INSULATION PROBLEMS

The illustrations of this article show the layout clearly; after arranging the parts specified, the aluminum panel may be drilled

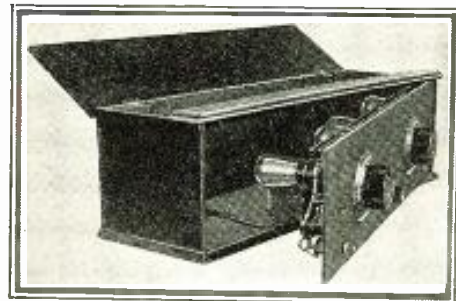

Quite unlike the customary set with which we are acquainted. The panel of this receiver contains all the apparatus.

for the apparatus. The radio enthusiast who is drilling aluminum for the first time will find that it is easier than he has imagined, in all probability.

The sockets and filament-resistance holders should be mounted first. Bend the prongs of the sockets upwards slightly and use fibre washers $\frac{1}{8}$ -inch thick to clear the sockets themselves from the panel. This precaution must be taken to preclude any possibility of short-circuit to the metal panel when the tubes are placed in the sockets. Likewise, ascertain that the contact clips of the filament-resistance holders do not come in contact with the panel, else there will be trouble.

The audio transformers are next in order and their bases are filed, so that they will make good contact with the panel. Thus the frames or cores of the transformers are effectively grounded and one is assured of freedom from transformer-howling.

Strict attention must be made to the mounting of the tuning condensers. As all types of straight-line-frequency condensers have grounded rotors, it is necessary to safeguard the rotor of the detector tuning circuit from short-circuit, by carefully insulating it with a fibre washer on each side of the panel. The reason for this is that the grid return of the detector tube is made to the positive side of the "A" battery, whereas the grid return of the R.F. amplifier is to the negative. It is necessary also to insulate the single-circuit jack so that the "B" battery will not be short-circuited.

The coils are mounted directly at the ends of the tuning condensers, and separated sufficiently to prevent direct coupling.

WIRING DIRECTIONS

The work of wiring a set is perhaps the most tedious and tiresome part of the construction. In his haste the builder often

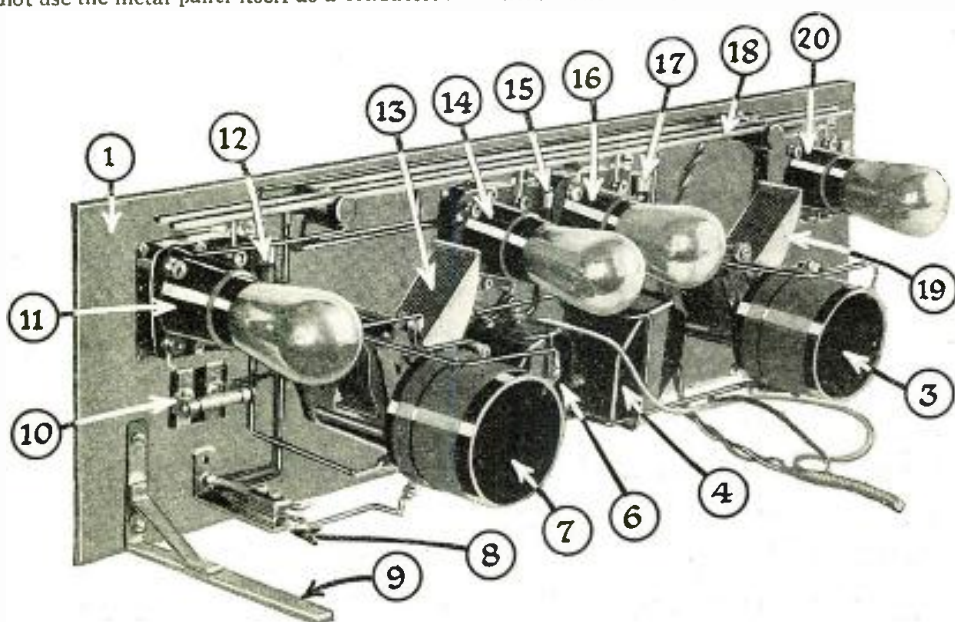

"Everything on the panel." 1, is the metallic panel itself; 3, 1st R.F. transformer; 4, 1st A.F. transformer; 6, 2nd A.F. transformer; 7, 2nd R.F. transformer; 8, output jack; 9, bracket; 10, grid-leak-condenser; 11, detector socket; 12, filament resistance; 13, detector-circuit tuning condenser; 14, 2nd A.F. amplifier tube; 15, filament resistance; 16, 1st A.F. tube; 17, filament resistance; 18, brass rods; 19, R.F. circuit tuning condenser; 20, R.F. tube.

overlooks the necessity for connections which will be both electrically and mechanically perfect. If ever it has been necessary to stress the necessity of adhering to the rigid rules concerning insulation, splices and joints, it is so here.

Heavy bus-bar is used, and covered with a better grade of spaghetti or cambric tubing. For the battery circuits, however, two parallel brass rods, 1/8x1/8-inch, are used as bus leads, from which the necessary connections are taken off. These rods, one of which carries the "A+" and the other the 90-volt "B," are two inches shorter than the panel; they are supported on two short lengths of fibre rod, 1 1/2 inches high and 1/2-inch diameter.

A word of caution against reversing the polarity of the grid returns of the various tubes. The negative terminal of the "A" battery is grounded to the panel. Make sure that the grid returns from all tubes except the detector are grounded.

No binding posts and accompanying post-panel are used, as this method of making connections is becoming antiquated. Instead the tell-tale varicolored cable leads are employed. The ends of the wire are carefully soldered, after the appropriate color scheme has been determined.

MERITS OF THE SET

The detector tube cannot oscillate, from

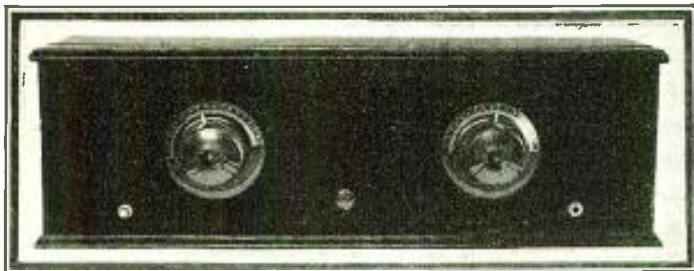

The complete metallic-panel-mounted receiving set, showing the two tuning controls, and stabilizing control in the center, which varies the 400-ohm resistor.

the nature of the circuit; but the R.F. tube can and will, unless properly controlled. Satisfactory reception cannot be had with this tube in a state of oscillation; and for this reason the 400-ohm resistor is included. By this means it will be possible to cover the whole broadcast range with complete ease of control.

The metal panel not only acts as a common ground for various "A—" connections, but also as an effective shield. Extremely fine tuning is obtained and distant stations will come in with an ease known only with sets which are not troubled by hand capacity.

The set may be mounted in a horizontal position, for which the one illustrated was designed, or on a vertical panel. Stations may readily be "logged" and signals brought in loud and clear by adjusting the potentiometer so that the first tube is in a condition just below the point at which oscillation takes place.

What may seem a serious drawback—the use of insulating washers between the apparatus and the metal panel—is nothing more than a method of getting around the old procedure of using an insulating panel and then undoing it by pasting tinfoil on the back.

This article is not written to create a stir, or even flutter, but to bring to the attention of radio enthusiasts that they should occasionally try stepping off the beaten path. No radical step, deviating from the customary run of hook-ups, has been taken; but we claim that a new design, compact and sturdy, in radio-receiver construction has been achieved, and is meritorious enough to command attention.

PORTABILITY OF THIS TYPE

Such a receiver is of very sturdy construction, which will enable its builder to use it on most strenuous trips; as for instance on cross-country automobile journeys. Or, if one has a motor boat and desires a set which will stand the knocks of the engine and the

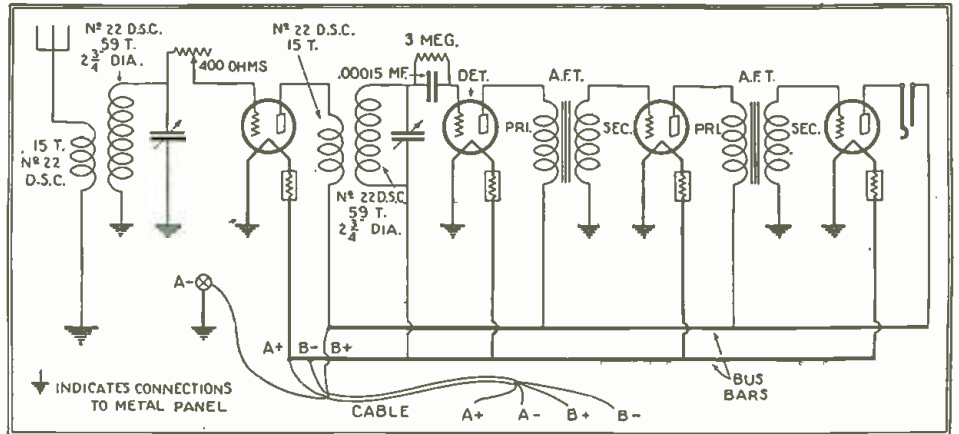

Circuit diagram, showing method of grounding return wires. Note parallel heavy bus leads, one for the positive "A" and the other for the positive "B".

lash of the waves, he can not do better than choose the metallic-panel type of receiver. It is not to be implied that the constructor should limit himself to the circuit employed in this instance. There are so many others that he may use an entirely different one, without fear of running into complications.

If distance-getting ability is wanted, a super-heterodyne, or multi-stage tuned radio frequency receiver will answer the purpose.

LIST OF PARTS FOR PANEL-MOUNTED SET

- 1 Aluminum Panel, 24x7 inches,
 - 2 Brass Rods, 22x1-8x1-8 inches,
 - 2 Variable Condensers, .0005 μ f.
 - 4 Standard Sockets,
 - 4 Fixed Filament Resistances,
 - 2 Audio-Frequency Transformers,
 - 1 Variable Resistor, 400-ohm,
 - 1 Filament Switch,
 - 1 Grid Condenser, .00015- μ f.,
 - 1 Grid Leak, 3-megohm,
 - 2 R.F. Transformers,
 - 1 Single-Circuit Jack.
- Approximate cost of parts \$25.00.

able on the market several kinds of stained and grained panels, both metallic and insulating, and it is sometimes very difficult to distinguish between them. This should convince those who doubt that a metal panel can present as good an appearance as the other type, that this is really the case.

Some manufacturers are beginning to realize the value of metallic panels and are employing them as standard equipment in their receivers. These have met with popular favor and appreciation. However, the use of the metallic panel as at once a mechanical support for the instruments, a

(Continued on page 258)

IT is against the policy of RADIO NEWS to publish the names of manufacturers or of makes of instruments in connection with the apparatus described in these pages, but this information will be gladly given privately. If you are interested in any special instruments described here, address a letter to the I WANT TO KNOW DEPARTMENT, enclosing stamped return envelope. The names and addresses of the manufacturers will be given free of charge.

—EDITOR.

ADORNMENT OF THE SET

If one is adept at graining, he can make the panel appear to be of handsome mahogany; or else, by the use of the correct grade of enamel, the beautiful finish of curly maple or Circassian walnut can be imparted to the smooth surface. There are now avail-

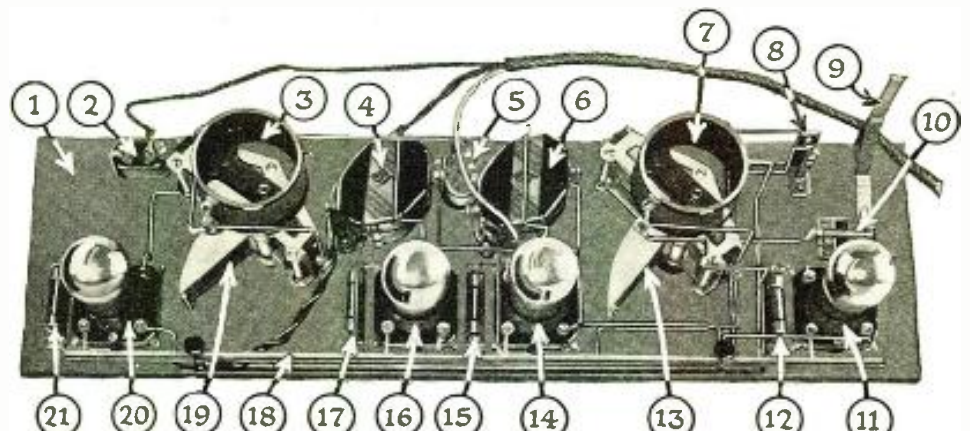

In addition to those parts listed in the view on the opposite page, 2 is the filament switch; 5, the 400-ohm variable resistor; and 21, the filament resistance of the R.F. tube.

The Hobodyne

By "BO" MCHINNESSEY

The following remarkable communication has been received by RADIO NEWS, proving conclusively into what universality radio has now penetrated. The set illustrated was sent in with the manuscript.

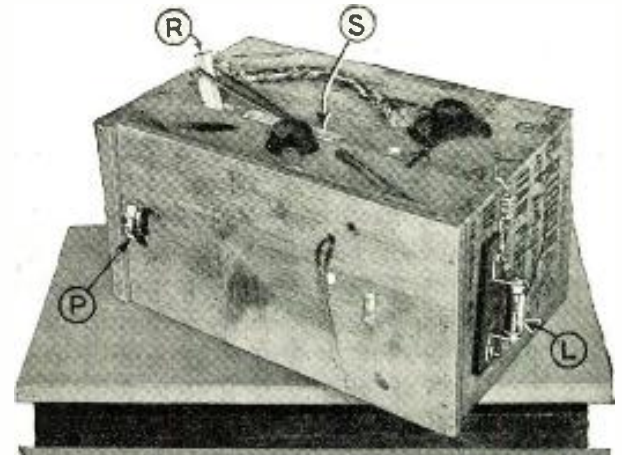
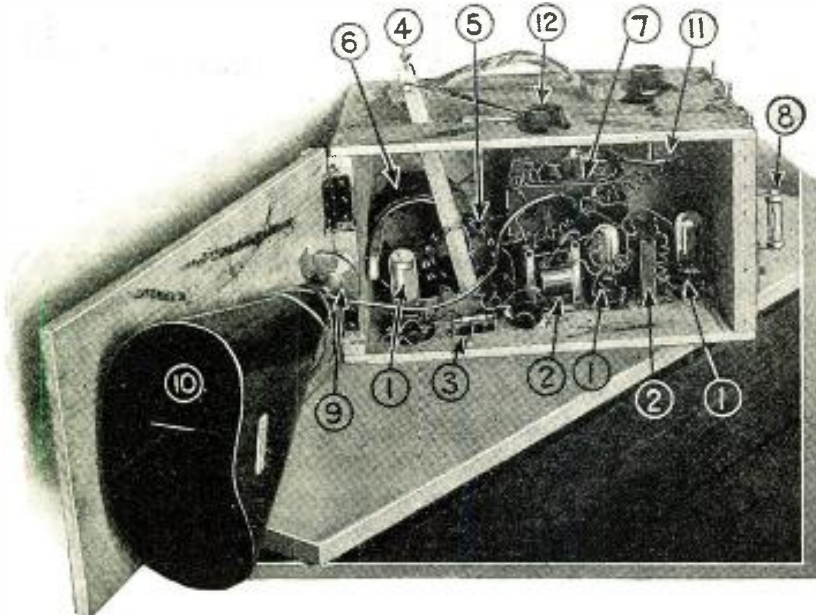

"R"—regeneration control; "S"—ruler upon which indicator attached to "R" slides; "P"—loud speaker unit shown at (9) in photograph to left; "L"—lightning arrester. The handle on top of the box is a piece of rope nailed to the box.

1, 3-volt battery tubes; 2, Audio frequency transformers; 3, Grid leak; 4, Regeneration control; 5, Movable tickler; 6, Primary and Secondary; 7, Dry cells; 8, Lightning arrester; 9, Loud speaker unit; 10, Horn; 11, Variable condenser; 12, Rheostat.

1 SENDS you by expres and in a freight car wich way i allways travell miself mi portable rado outfit as she aint werking no longer my old pardner Red Mike O Shawnessey maide the sett for me at first and she shure werks grate at first but Red hit the rods to florida and left me with the sett on mi hands we thats me and me freind Scotty Macpherson used it on our vacation in the woods near Collumbus ohio for quite a spel this seasen and it shure was good to here all those many rado stashions but they chased us outa the old cabin wich we was using and the rado fell frum a braikbeme wen we was coming east i tried to fix her up but no good she doesnt perk a cents wurth when my old pal Red Mike first maid the sett i watcht him lie haveing bin a tinnsmith in his younger dais and he shure new the werks we picked up stray rado parts in varies plases til he had enuf to make the sett Red shure was grate in asembling the rado and she shure perked well since then i have bought many copies

of RADO NEWS trying to fix her up but its no good i mean the sett its just so much junk if not more i giv you the cirkit as i now hav her wired butt i think miself its rong

i must not forget too tel you how proud Red O Shawnessey was about wat he called his regenrashion control shown on the outside fotygraft R is a stik wat moves a brass pointer over a piece of ruler S so he cud allways tel wher you was tuned in at the kondenser dile was set for instinct at 90 and the regenrashion controll at 15 inches that gav us Wlw sinncinati 15 1/2 inches gav us WtAm cleveland mity fine work sez i the litning arrester L came in reel handy one nite wen we was hit by a bolt but it never hurted the sett except nocking a peice off of one of the diles the lowd speker unit was sett neatlly thru the door of the sett wher it ouldnt cum out

all the parts we nailed down no screws was used Red was all swelled up over it becz he clamed his is the first and onli sod-

derless sett not one soddering was used but dont forget to tel your reeders about the regenrashion controll sea the works fotygraft wear it is shown at 4 6 is a large coil 4 is a stik wich you wigle back and forward til she skweels like a ratt and 5 is the coil attached to the stik by rubber banns

all the prety curlikews of wire Red was very proud off he often sed that they wer the rado frekwensi chokes but never onct did i sea that the rado choked exsept wen it fell from the train after that it choked frewentli so please help a poor bum out who wants to use his rado you can send it back cod wen you have repared it mi pardner and me are each hartbroke becaze we cant lissen to the prety ladies warbel thanks a thousand times for your kindnes

Bo MCHINNESSEY.

P.ESS

if the b bateries are worn out you need not send new ones there is a farm house around hear wher we can borro a fiew wen the foks are out in the field

p.ESS No. 2 large sup cans mak the best groun but they shud all be buried 2 ft. underground will this rado werk better if i berry it under grount i seen your artikle about Rogers underground rado tel me how to do it.

Mc

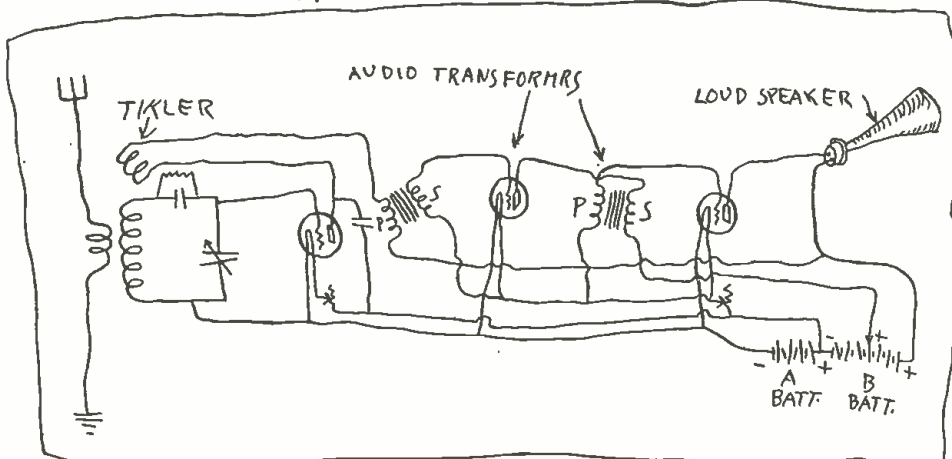

The complete circuit of the Hobodyne, a photographic reproduction of that submitted to us by Mr. "Bo" McHinneseey. It is quite a revolutionary circuit and a number of most interesting things happen as soon as the batteries are turned on. It will be noted that Mr. McHinneseey left out the lightning arrester from his hook-up. We have reason to believe, however, that he has it connected across the aerial and soup-ground.

GRAND PRIZE CONTEST

Study the adjoining hook-up of the HOBODYNE carefully. It is our opinion that Mr. McHinneseey has made a number of mistakes. We counted about 10 mistakes ourselves, but we may be wrong. There may be more, and perhaps less. To the reader who sends us in the correct list of mistakes, 3 guaranteed blown-out vacuum tubes will be awarded. Other prizes are listed below:

PRIZES

- First Prize... 3 blown-out vacuum tubes
- Second Prize
1 "B" battery with negative voltage
- Third Prize 1 genuine catwhisker
- Fourth Prize 2 lbs. of fresh ground
- Fifth Prize 1 (feather) tickler

This contest closes at once. Address all replies to "Bo" McHinneseey, General Delivery, U. S. A.

The Detectorium

By HUGO GERNSBACK

The Editor in this article describes a little-known instrument. Mr. Gernsback actually tunes with a crystal detector. This instrument was patented in 1910, at which time it was used extensively.



IN view of the growing popularity of the crystal detector, especially in our large cities, I believe that experimenters all over, particularly the new-comers, will be interested in an instrument invented by me in 1910. The Detectorium, as it was designated by me at that time, was patented June 21, 1910 (U. S. Patent No. 961,855.)

During all the years since broadcasting has come into vogue, I do not recall having seen the device described; but it was so good in the old days, and performed so remarkably well, that I feel it my duty to bring it again to light. It was originally described in the world's first radio magazine, which I published; namely, "MODERN ELECTRICS," in the July, 1910, issue.

The Detectorium is interesting chiefly because it does two things at once. Instead of first adjusting the detector and then tuning by means of switches or sliders, in the Detectorium these two operations are performed in one. As the illustration shows, the detector has become the tuning slider.

The great utility of a device of this kind will be seen immediately, particularly for sets that are to be transported a good deal.

In my 1910 experiments I quickly found that the only good minerals were Silicon,

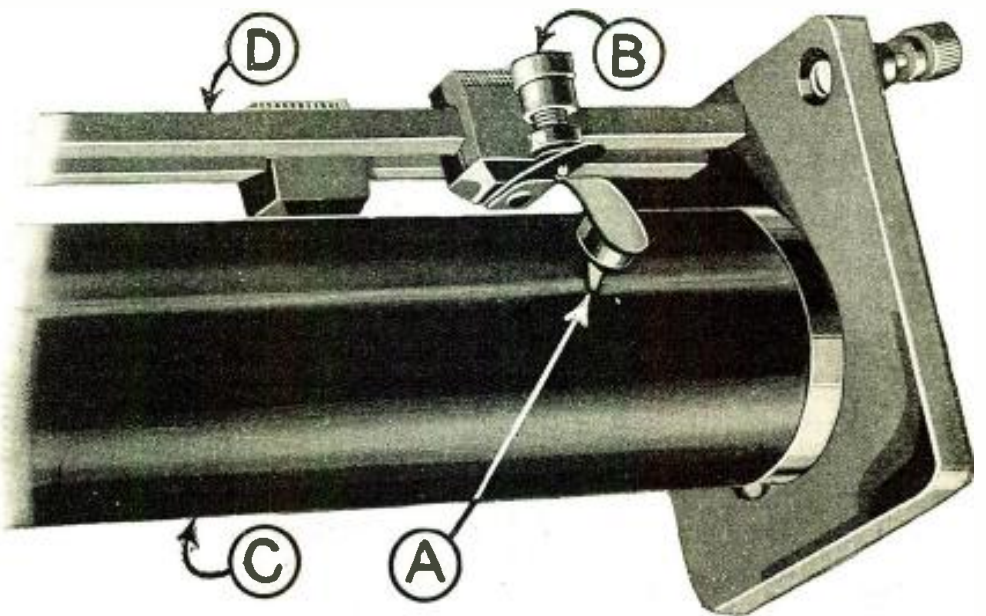

Fig. 3. Close-up view of Detectorium, showing D, slider, B, adjusting screw to bring crystal cup with crystal into contact with wire convolutions, A, crystal, and C, tuning coil.

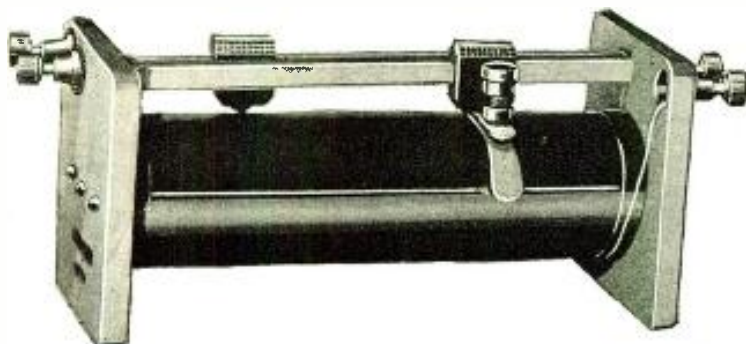

Fig. 2. View of the complete Detectorium, with its two sliders. Note one slider with its crystal cup. Right, Fig. 1, shows a different means for attaching crystal to slider, and spring for regulating tension of crystal.

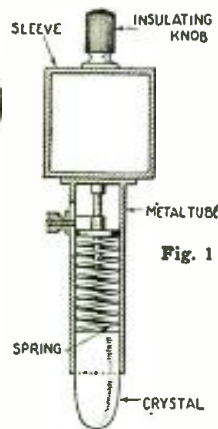

Fig. 1

greater than the present broadcast range. The coil at that time consisted of a two-inch tube about eight inches long, wound with No. 24 enameled or bare wire. The same size tube can be used today, with the exception that the wire should be about No. 18 or No. 20 B & S bare copper, which will cover the broadcast range surprisingly well.

The tube is put in a lathe, or similar winding device, and bare copper wire is used, winding with it, at the same time, a thick thread, to separate the wire convolutions so that they do not touch. The thread can remain, if so desired.

A slider arrangement as shown in Fig. 1, can be used if desired, or otherwise the arrangement shown in Figs. 2 and 3, which was the better arrangement, can also be used. If the slider shown at Fig. 1 is used, it is necessary to obtain a piece of silicon or other crystal of a form somewhat as shown; that is, a bullet-like shape. The ends can be rounded off nicely by grinding on an emery stone and afterwards polishing the crystal perfectly smooth. The end curvature should not be too small, otherwise two turns on the tuning inductance will be short-circuited.

(Continued on page 286)

Copper Pyrites, Iron Pyrites, Zincite, and Carborundum, in the order named.

A number of circuits showing Detectorium connections are shown on this page.

At this point I wish to say that I believe that our 1910 tuning coils with sliders are still way ahead of anything that is in use now. Very fine tuning can be done with a

double-slide tuning coil; much better, in fact, than in most devices used today.

CONSTRUCTION IS EASY

The Detectorium can be readily constructed by an experimenter, and no particular directions need be given here as to sizes. The illustrations show a tuning coil which was common in 1910, but whose range is

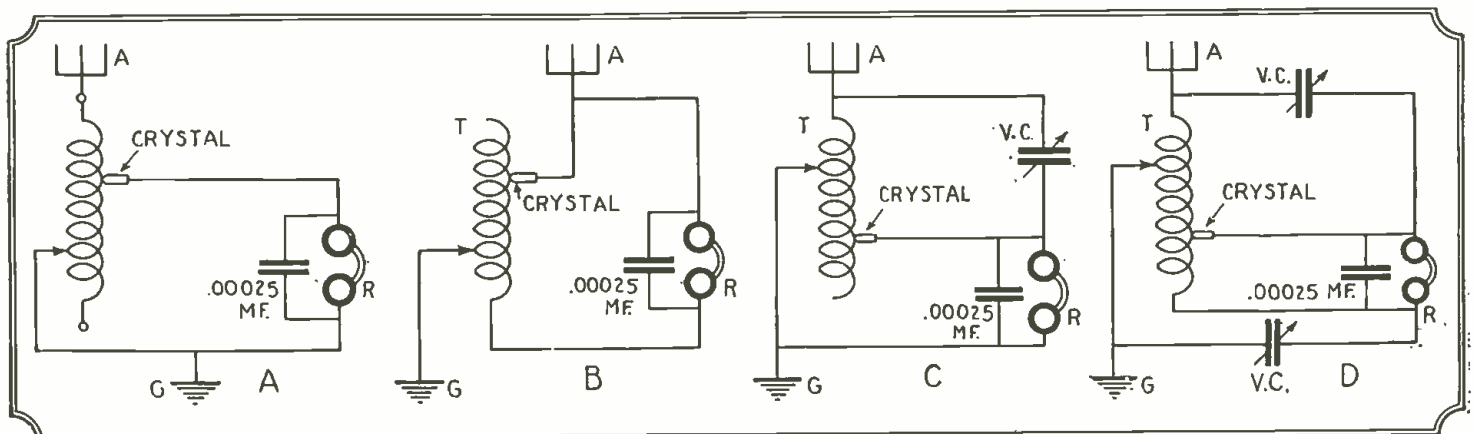

Various circuits for Detectorium. Where no sharp tuning is required, circuit A is quite satisfactory. Circuits B and D are used for sharp tuning. Circuit D is particularly good.

A Tuned-Radio-Frequency Regenerative Receiver

By ROY Lyster



The receiver here described by Mr. Lyster combines tuned-radio-frequency amplification, regeneration, and two styles of audio-frequency amplification. The distance and quality properties of this receiver should be of the best.



IT has been a very common occurrence, in this great game of radio, for two people to have receivers, which they have built themselves, employing exactly the same circuit yet affording the most widely different results. Of course, it may be that the skill of the operator enters into this equation; but in 99 per cent. of the cases the mysterious factor is in the wiring of the set itself.

In the old days of radio, if a receiver failed to live up to expectations the trouble was generally blamed on the apparatus; but this is an excuse of the past. The methods of manufacture and the rigorous tests undergone by the various parts that are put into the set, almost invariably forbid any such thought as this today. If any trouble is experienced with the set, it can in most cases be traced to the failure of the builder to meet some of the requirements specified by the manufacturer of the parts.

If a receiver employs tuned-radio-frequency amplification, as does the one described in this article, one of the most annoying effects possible is stray feed-back, due to magnetic coupling. This is most often the result of not carefully following the directions, when laying out the apparatus, or of poor and careless wiring. To overcome this evil, shielding may be introduced, which would be quite unnecessary otherwise; or the set may be reconstructed and rewired, the latter being the much wiser course to follow. It pays to rewire if any of the troubles caused by magnetic coupling are met; these being insufficient volume, lack of sensitivity, body-capacity effects and critical tickler adjustment.

FEATURES OF THIS CIRCUIT

In the illustrations accompanying this article the arrangement of the apparatus can be clearly seen and the constructor is advised to follow the details as carefully as possible. In the matter of inductances, it is of the

utmost importance that they be placed in the set in the same positions in which they are shown in the illustration. It will be noticed that the antenna inductance, L1 and L2, is placed at right angles to the radio-frequency transformer, L3, L4 and L5. This is to eliminate any chances of the annoying magnetic feed-back, which was mentioned above.

By reference to the circuit diagram it will be seen that this receiver consists of a stage of tuned-radio-frequency amplification, a regenerative detector, and three stages of audio-frequency amplification; the latter being one stage of transformer-coupled and two stages of resistance-coupled amplification. This combination in the audio-frequency amplification stages, has been found to give very good results. It will be noticed also that there are four binding posts on the sub-panel; between them will be seen a small switch, S2, which is introduced so that the three stages of audio-frequency amplification may be cut out and the set operated on the first two tubes. The switch, S1, is for the filaments of the first two tubes.

The binding posts just mentioned are an

The two outside dials turn the variable condensers and the center dial controls the tickler coil, L5. The left jack is for a loop antenna and the other two are indicated in the circuit diagram.



innovation in radio receivers, in that they have been incorporated in the circuit to accommodate experimenters, who wish so very often that they had "a couple of stages of audio" lying around some place, with which they could try a new tuner, for instance. By using these four binding posts,

regularly connected by jumpers, three stages of audio-frequency amplification will always be available to the owner of this receiver. All that is necessary to convert this set into a laboratory amplifier is to disconnect the two jumpers across the binding posts and connect the output of the tuner under test with the input side of the A.F. transformer.

CONSTRUCTION OF INDUCTANCES

For the construction of the antenna inductances, L1 and L2, a bakelite or hard rubber tube, 2½ inches in diameter and about 3 inches in length will be needed. On this the primary is wound, consisting of 11 turns of No. 24 D.S.C. wire. On the same tube is wound the secondary, L2, having 54 turns of the same sized wire. As will be seen from the accompanying illustrations, this antenna coupler is placed on the sub-panel in a horizontal position.

The radio-frequency transformer, which is placed in a vertical position on the sub-panel, uses a tube of insulation of the same size as the antenna inductances. The primary, L3, has 11 turns of No. 24 D.S.C. wire, and the secondary, L4, 54 turns of the same

size wire. It will be noticed from the wiring diagram that there is a rotor, L5. This inductance, for regenerative purposes, is wound on a tube 1½ inches in diameter, and consists of 36 turns of No. 30 D.S.C. wire. It must be so mounted that it may be rotated with respect to the secondary of the tuner, therefore it must be at the same end of the tube on which L4 is wound. The adjustment of this inductance, L5, is made

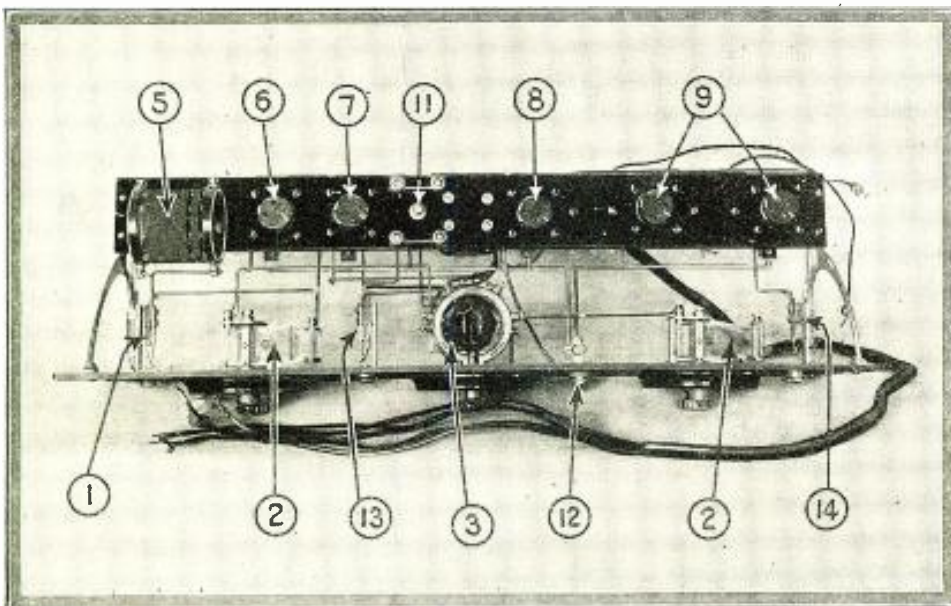

No. 1 is the loop antenna jack; 2 variable condensers; 3, three-circuit tuner; 5, antenna coupler; 6, R. F. tube socket; 7, detector socket; 8, transformer coupled A. F. stage; 9, resistance coupled A. F. stages; 11, switch, S2; 12, switch, S1; 13 and 14 jacks.

Photos courtesy of Bruno Radio Corp.

LIST OF PARTS

- 1 Antenna Coupler, L1 and L2;
 - 1 Three-Circuit Tuner, L3, L4 and L5;
 - 2 S.L.F. Variable Condensers, .0005- μ f.;
 - 4 Automatic Filament Controls;
 - 1 A.F. Transformer, ratio 3½:1;
 - 4 Resistors; two 0.1 megohm and two 1.0 megohm;
 - 1 Variable Grid Leak;
 - 1 Fixed Condenser, .00025- μ f.;
 - 3 Vernier Dials;
 - 2 Double-Circuit Jacks;
 - 1 Single-Circuit Jack;
 - 5 Standard Vacuum-Tube Sockets;
 - 2 Fixed Condensers, 0.25- μ f.;
 - 2 Battery Switches;
 - 1 Panel, 7x24 inches, and sub-panel, 2½x24 inches;
 - Bus-bar, binding posts, flexible battery leads, etc.
- Approximate cost—\$37.50.

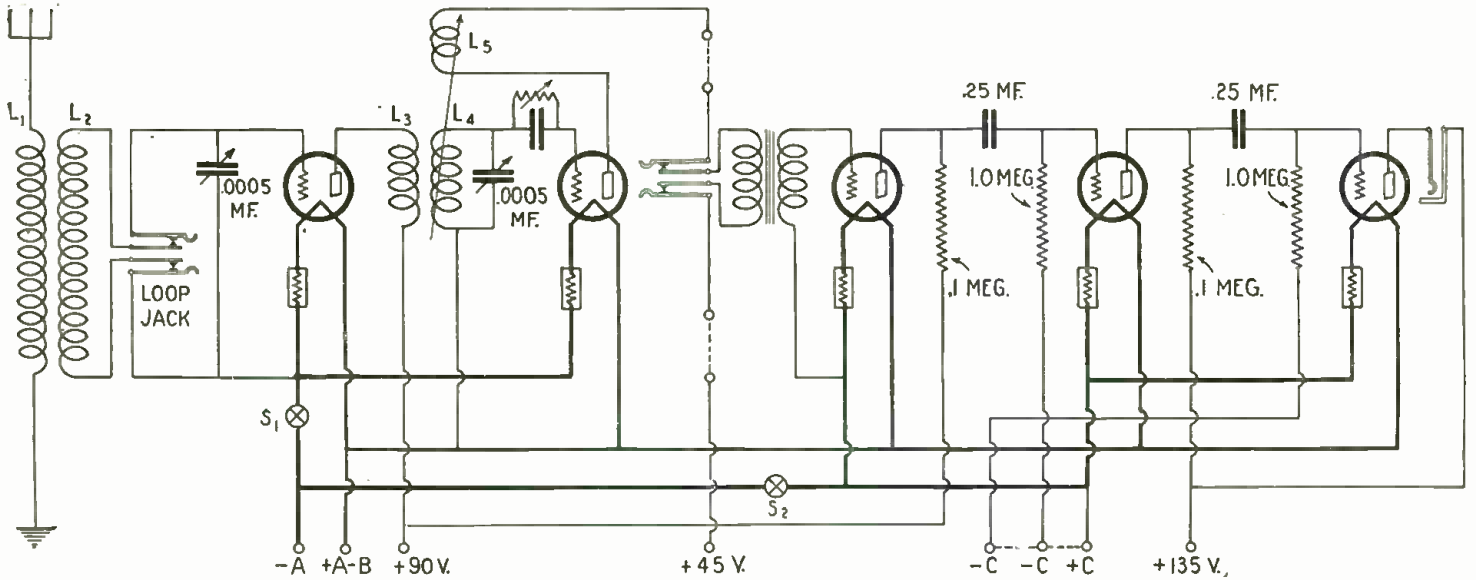

The five tubes of this receiver are put to excellent advantage, in that regeneration is employed as well as R.F. amplification. The A.F. amplifier is especially commendable.

from the front of the panel and is controlled by the middle dial of the receiver.

WIRING PRECAUTIONS

The wires connecting these inductances to the other apparatus in the receiver should be very carefully run, as it is here that the troubles mentioned above may occur. It is important that none of these wires run parallel to the others, and that they are as far apart as possible. This does not mean that they should be run all over the set, but there is a happy medium of which the constructor must acquire the knack.

There are three jacks on the front panel, the one on the left being for a loop antenna. When a plug, connected to a loop, is inserted in this jack, it cuts out the antenna coupler and shunts the loop across the variable condenser. The middle jack is in the plate circuit of the detector tube, for phone reception of local stations. The jack on the right is in the plate circuit of the last amplifier tube, for loud-speaker reception. In wiring these three jacks the utmost care should be exercised to see that good contact is made, for it is here that many troubles in receivers originate. In order to further simplify this receiver all rheostats have been omitted; there being installed instead automatic filament controls.

In the last stage of audio-frequency amplification one of the new power amplifier tubes may be employed to good advantage. The use of a tube like this will increase the volume of the output many times, and there is very little additional expense. If one of these tubes is used, not less than 135 volts should be used on the plate, and sufficient negative grid bias. In the circuit diagram there is shown a separate "C" battery for the last two tubes, thereby allowing for the use of a power amplifier. However, if a regular amplifier tube is used, then the same negative grid-bias may be used in the two stages of resistance-coupled amplification.

The use of straight-line-frequency condensers is advisable, as the stations having

a lower wave-length may thus be tuned in with greater ease. They have a capacity of .0005- μ f., and should be mounted as shown in the accompanying illustrations, in order that leads as short as possible may be run,

An average antenna, about 100 feet in length, may be used and the results will compare very favorably with those from any other set having an equal number of tubes. The tubes to be used should be the

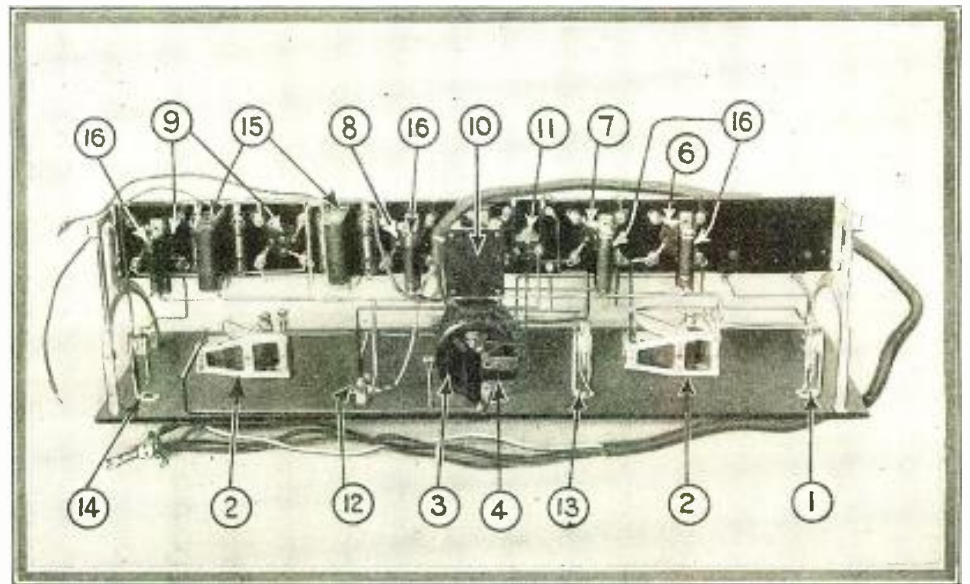

No. 4 is the grid condenser and leak; 10, the A.F. transformer; 15, 0.25 μ f., fixed condensers; 16, automatic filament resistances. The other parts are numbered as on the opposite page.

The operation of this receiver is relatively simple, as the two condensers have about the same dial settings for each station; and the same stations should come in on identical settings night after night. The adjustment of the regenerative dial will not prove to be a very difficult task; for, if a slow-motion dial is used, very accurate adjustments can be easily made. As has been suggested above, a loop antenna may be used with this set, a jack being indicated for the purpose. If a loop is not to be used, the inclusion of this jack in the circuit is unnecessary and it may be omitted.

201-A or 301-A type, as these will give us good results as can be expected.

IT is against the policy of RADIO NEWS to publish the names of manufacturers or of makes of instruments in connection with the apparatus described in these pages, but this information will be gladly given privately. If you are interested in any special instruments described here, address a letter to the I WANT TO KNOW DEPARTMENT, enclosing stamped return envelope. The names and addresses of the manufacturers will be given free of charge. —EDITOR.



Tubes Within Tubes



IN the July, 1926, issue of RADIO NEWS, appeared an article by G. C. B. Rowe entitled "Tubes Within Tubes." In that article we neglected to state that the vacuum tube described, containing in addition to the thermionic elements a complete resistance-capacity-coupling system, is the result of work done by Dr. Sigmund Loewe, on the thermionic

elements, and by Baron Von Ardenne, on the circuit arrangement. This work was done in the Loewe laboratories in Berlin.

In the same issue an article entitled "New Radio Devices of Fixed Precision," describes a quartz resonator used for accurately determining and measuring radio frequencies.

The original idea of the luminous quartz, as employed in this device, is due to Prof. Giebe and Dr. Adolph Schiebe, both of the German Bureau of Standards. These scientists worked in conjunction with the laboratories of the Loewe Radio Co. of Berlin, in the development of the resonator.

Powerformer Combines "B" Eliminator and Power Amplifier

By D. E. HARNETT*

Here is an article dealing with the new combination of power amplifier and "B" battery eliminator in one unit. This is certainly a step in the right direction.

AN interesting development in new apparatus for the receiving sets has recently been put upon the market. It is a combination "B" battery eliminator and audio-frequency amplifier; and it should be stressed that the amplifier is one employing power tubes. This accompanying article is a general description of the unit; in forthcoming issues of RADIO NEWS there will be found detailed constructional information.—EDITOR.

WE have had our low-loss-condenser fad, our low-loss-coil fad, our T.R.F. fad, our neutralized-circuit fad, our . . . (ad infinitum . . . fads; and now we are going to have our period of enthusiasm for "eliminators" of all sizes and breeds. The market will soon be flooded with "eliminators" some will eliminate and some will not, some will be worth using and others will be fit only for the junk pile. Some will be high-priced, and others might without extravagance be given away as souvenirs.

Next season will teach designers and builders of eliminators more than could several seasons of laboratory work; for in the placing of eliminators in countless homes a multitude of problems will arise and will be overcome, which never would have been present-

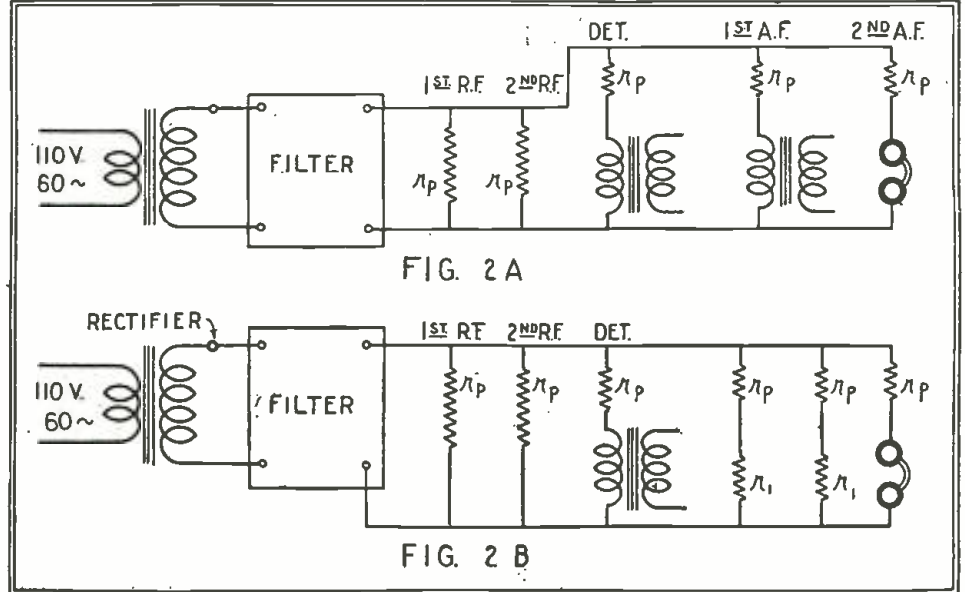

These two diagrams illustrate how the impedance, into which a filter system of a "B" eliminator works, varies with the type of receiver being energized by the eliminator. Figure 2A represents a filter working into the load furnished by a receiver having two stages of R.F., detector and transformer coupled A.F. Figure 2B shows the equivalent of the filter load furnished by a receiver having two stages of R.F., transformer-coupled detector, and a resistance-coupled amplifier.

ed in the laboratory where such equipment is designed.

Eliminators can be made to function as

perfectly as practical operating conditions demand. This has been known for a long time. Fundamentally they are not new; so that it is not mainly the electrical design, but the adaptation of that design for quantity production, and the efforts of the manufacturer to keep his costs within bounds, that will present the greatest problem.

An eliminator, designed to furnish a steady, direct current when connected into an alternating current main, consists of two principal elements; viz., a rectifier of some kind, and a filter. There are various kinds of rectifiers, all of which have different characteristics, and some of which are better under one set of conditions, and some under another; some have fairly good voltage characteristics, and others no well-defined characteristics at all.

As regards the filter; the design of a good filter to attenuate small alternating voltages, within given frequency bands, is not a difficult matter when there is no direct current in the circuit, but in eliminators of the type we are now considering the problem is complicated by the fact that a considerable amount of direct current must be passed. This confines the design to those types of filter which have no condensers in either line, but only across the line; and at the same time requires that the impedance coils used in the line have high impedance to the A.C. voltages and low resistance to the D.C.

The design of eliminators is further complicated by the fact that they have to work under varying conditions. The terminal impedances, connected to such a network as a filter, have considerable to do with the manner in which the filter acts. To be more explicit, let us refer to Fig. 1. Here we have a source of electromotive force acting into the network of the filter, and the filter acting into a load. We can analyze it very well as a transmission line, in which the impedance of the source of electromotive force (or transmitter) is Z_T and that of the load (or receiver) is Z_R . There must be a definite ascertainable relation between these two im-

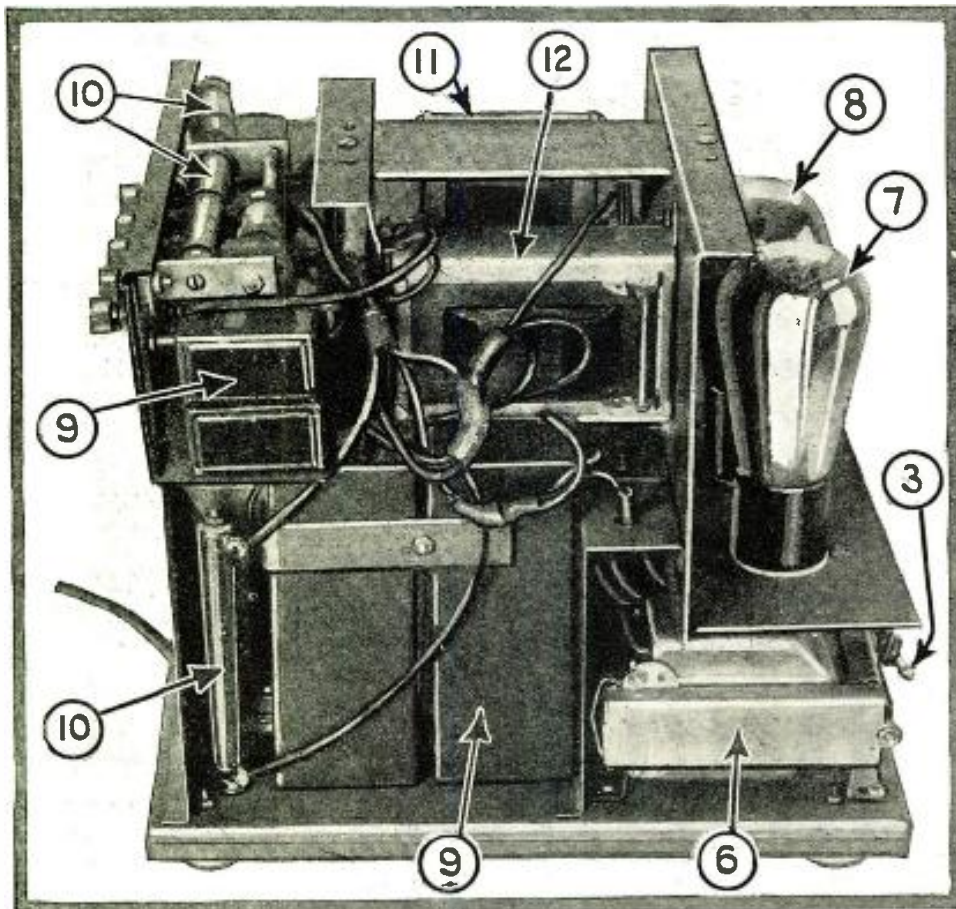

The interior of the Powerformer is here shown. The numbers correspond with those shown in the photo on the opposite page. The complete numbering system follows: 1, Power amplifier transformer; 2, output jack (to loud speaker); 3, control switch; 4, pilot lamp; 5, input jack; 6, power amplifier transformer; 7, amplifier tube and socket (UX-210); 8, rectifier tube and socket (UX-216B); 9, filter condensers; 10, filter resistors; 11, 12, filter chokes.

*Research Engineer, Patent Radio Corp.

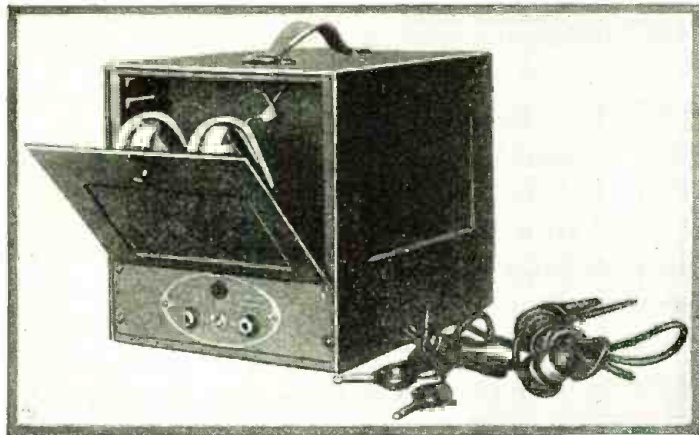

A commercial form of the Powerformer, completely enclosed in a metal case. The front part of the case tilts forward, as shown, to enable the operator to remove the tubes. The pilot lamp within lights up a red indicator, shown immediately above the control switch.
Photos courtesy of Pacent Radio Corp.

pedances, and likewise between either of these impedances, and the end (or terminal) impedances of the filter, in order that the filter may be made to function properly.

Now, the impedance of the source presents no serious difficulty, for this can be regulated by the manufacturer in the design of the power transformer; but the problem of the load impedance is a serious one. In one case the eliminator will be called upon to supply energy for a five-tube set, having two stages of R.F., a detector tube and two stages of A.F. amplification. The "B" voltage has to act through the plate resistances of the two R.F. tubes, paralleled by the plate resistance and transformer impedance of the detector and first A.F. stages, and also paralleled by the impedance of the last stage, which consists of the tube resistance in series with the impedance of the telephone or loud speaker. The situation is represented in Fig. 2A.

VARIATIONS IN THE LOAD

To see the exact idea we mean to bring out here, glance at Fig. 2B. Here we have a T.R.F. amplifier working into a detector which is transformer-coupled to a three-stage resistance-coupled A.F. amplifier. In this, as well as in Fig. 2A, r_p represents the plate resistance of the tube. In Fig. 2B r_i represents the coupling resistance in the A.F. amplifier. It is plainly evident from these two figures that the load impedances connected to the filter terminals are *not* the same in both cases; whereas the impedance connected to the input of the filter is the same, as this is determined solely by the power transformer. It is possible that this variation in the load impedance among other things accounts for the fact that certain eliminators will work well with some receivers and not so well with others. There is no doubt that after a little more experience in this line such problems will be found less serious.

The matter of power amplification has been under discussion for quite some time, so little will be said concerning it here. The outfit described in this article consists of a "B" battery eliminator and a power amplifier working off the same transformer. The wiring diagram is shown in Fig. 3. The alternating voltage from the house-lighting system is impressed on the terminals of the transformer shown at the left; and when the switch is closed the pilot light indicates that the system is in operation.

A CURRENT-SUPPLY SYSTEM

The transformer consists of a primary and three secondary windings. One winding feeds into the rectifier-and-filter circuit; the rectifier tube is a UX-216B, the filament of which is energized by one of the low-voltage windings of the transformer. The upper or B- line of the filter is connected directly to the high-voltage winding; while the lower or B+ line is connected to the middle of the rectifier-filament winding. The filter is the usual low-pass filter, the main problem in the design of which lies in the values of the impedances.

The output of the filter is connected to a

age is not taken from the resistance connected directly across the positive and negative leads from the filter. It is taken from a fourth resistance for the purpose of loosening the coupling between the detector and the first A.F. amplifier by means of the extra resistance, so that A.F. regeneration and other difficulties may be avoided. All these tappings are by-passed by condensers of adequate size.

In the upper portion of the diagram is shown the circuit of the power amplifier. This is a UX-210 tube, the filament of which

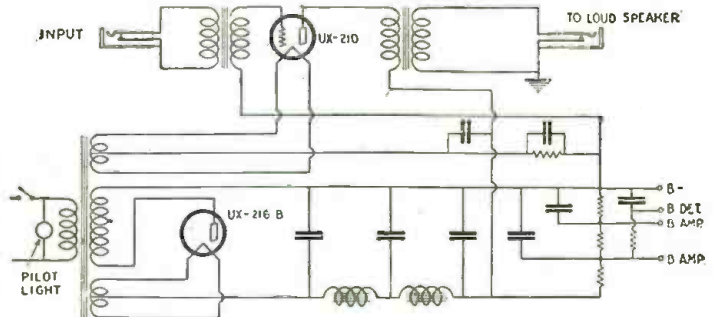
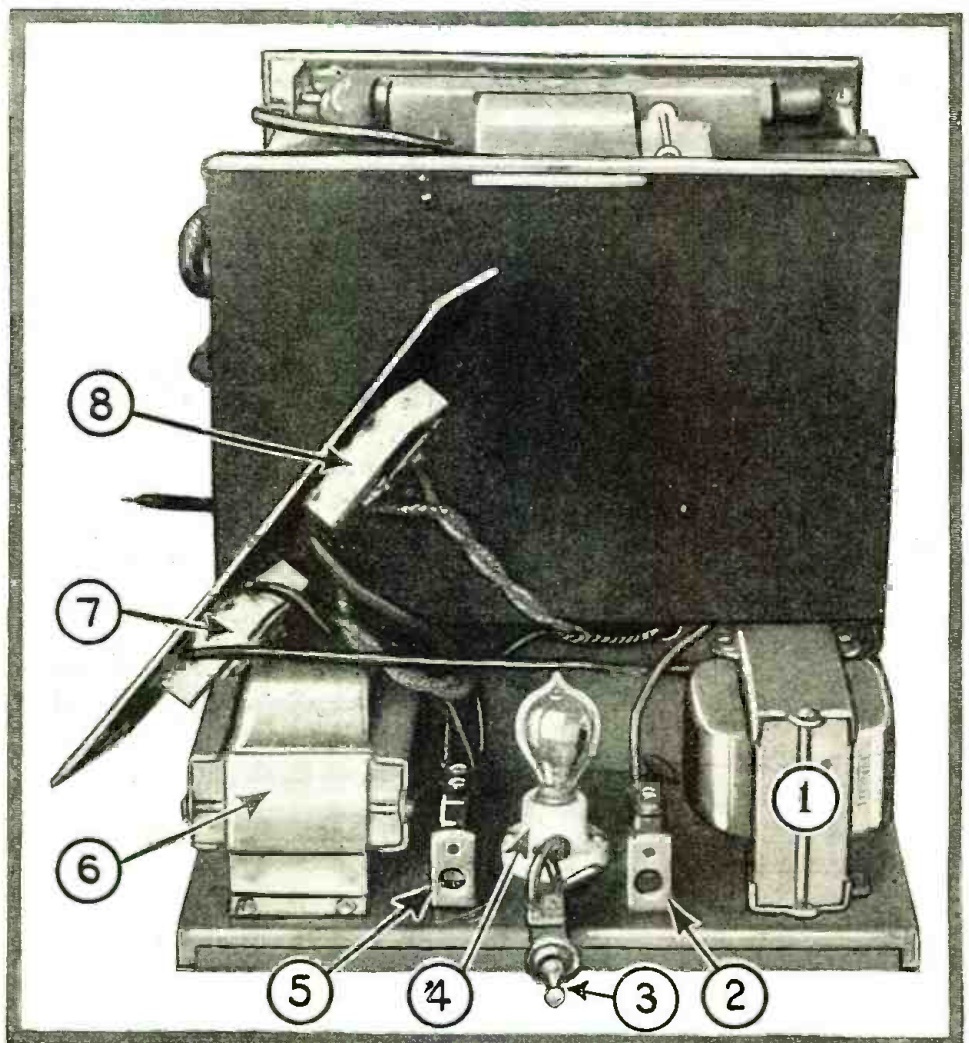

Fig. 3. The circuit of the Powerformer. Lower left to right, the power transformer followed by the rectifier tube and filter circuit. Above the filter circuit is the circuit of the power amplifier with input and output transformers and jacks.

series of resistances which enable various voltages to be tapped off. It will be noted that there is a resistance connected in series with the lower (or B+) line of the filter and the voltage-amplifier tap. The reason for this is that the transformer has been designed to furnish about 385 volts, to operate the power amplifier (at the top of the diagram) properly; and only about 90 volts is required to operate the amplifiers in the receiver to which the eliminator and power amplifier are connected. It will be noticed also that the tapping for the detector volt-

is energized by one of the low-voltage windings on the power transformer. The grid return of the power tube is connected to the middle of the winding which energizes the filament. In this middle tap is connected a resistance, which determines the bias on the grid of the tube, and is properly by-passed by a large condenser.

An extension cord with a plug on each end connects the output of the radio receiver to the jack shown at the upper left of Fig. 3. This is connected to the output of the power
(Continued on page 276)



Another view of the Powerformer. The numbers in this illustration correspond with the numbers given under the photo on the opposite page. For both of these views the metal shielding case has been removed, and the tube platform "hung in air" to clearly show the arrangement.

Alleviation of Static

By L. W. HATRY

In this article Mr. Hatry gives some information concerning the reduction of that bug-bear of the radio fan, static. This field of effort is a worthy one for experimenters, as there is much to be ascertained along these lines.

PERHAPS this article should start with a cheerful statement, of the customary nature, regarding the vast amount of scientific effort expended in attempting to solve the baffling question: "Why can't static be eliminated?" Of course it should be pointed out that the earlier efforts were aimed at elimination, whereas the later ones have been devoted to the more practical attempts at alleviation; or, in other words, to a reduction of the static so that the desired reception can be obtained in spite of the interference. There is no reason to avoid the subject of "elimination," except that "it can't be done." This article will therefore be confined to practical methods for alleviation of the nuisance, and will avoid expensive and complicated schemes.

A HINT FOR "HAMS"

A practical, yet simple, scheme which is sometimes unusually effective is shown in Fig. 1. Yes, it seems absurd; it is merely a tuned antenna circuit, yet few of the less difficult arrangements will better it. The average short-wave receiver has a fixed-tune primary or antenna circuit. Static is as bad with a tuned as with an untuned arrangement; but the signal is definitely improved by the use of tuning in the antenna circuit. However, the use of tuning is not the only trick; it is necessary to adjust for very loose coupling, which cuts the volume of the static much more than that of the signal.

This loose coupling may seem excessive, but a special plea must be made to stress its importance. The sacrifice of signal strength reduces the static to an even greater degree.

It is practically impossible to reduce this looseness of coupling to definite figures. Coil fields differ so with dimensions and trivial changes, antenna resistance likewise; and the resultant of these two variables is a coupling, for the purpose of static alleviation, for which there is no hard and fast rule. The important thing is to loosen the coupling to such a point that resonating the antenna has no longer any particular effect upon oscillation and does not demand a consequent "increase" in the adjustment of its control. When your antenna coupling has reached that degree, you will begin to realize an alleviation of static.

EASIER IN CODE WORK

Let us resolve the problem to an understandable position. Static elimination sounds

impractical; it is unreasonable to suppose that a thing so nearly in the exact nature of the received signal can be completely eliminated without completely eliminating the signal also. It may possibly be done, some time; but let us face the facts as we understand them. The thing to be done is to reduce the static, if it completely destroys signal intelligibility, to a degree that will permit signal reception. This is less difficult for radiotelegraphy than for radiotelephony. A constant and steady tone frequency is, at least theoretically, possible in radiotelegraphy; and it can be made sufficiently distinct from static, to permit differentiation and be read, by its tone alone.

In fact, the adjustment for constant tone, and the use of tuned audio transformers, is mainly to accentuate the advantage of the tone in contrast to the notable lack of it in static discharges. The manifest advantage of telegraphy over telephony in this

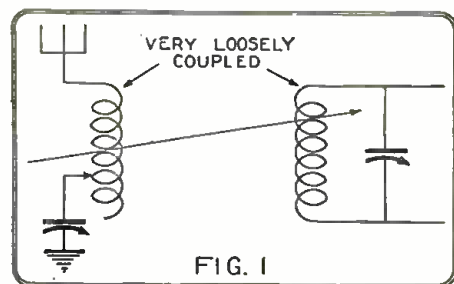

FIG. 1
A tuned antenna circuit, such as the one above, helps greatly to reduce static.

all that, the signal itself, because it is a sustained frequency, fares better than the static.

If the static comes through too well, it is because of the low resistance of the secondary circuit, and this may be overcome by a variable resistance, as shown in Fig. 2. It may seem foolish to add resistance to a circuit where it should be kept low, but it must be done. It is not too easy to prescribe the exact resistance required; it should be of a type permitting a complete cutout to leave the tuned circuit at its own minimum. One variable to 400 ohms is sufficient, and may be made practically non-inductive by winding in a special fashion. Any variable 400-ohm resistance will do if the tuning effect is recognized and compensated by the tuning condenser.

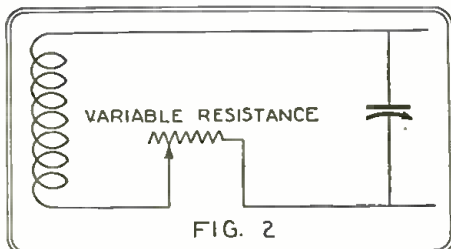

FIG. 2
A variable resistance in series with the secondary of the tuner is a simple thing which often helps.

matter is great; it may be estimated safely that static of ten times the severity necessary to stop phone reception will not prevent successful telegraphic communication. We need a signal-to-static ratio that permits signal intelligibility, nothing more.

USE OF RESISTANCE IN SECONDARY

To obtain this reduction in ratio, we may take advantage of a number of things. One has been mentioned, the tone-frequency of the received signal; another is the fact that the received signal has its radio frequency resonance. This latter, however, is more or less useless because of the fact that static, being nearly without period, serves to shock (or impact) the secondary circuit into oscillation at its own frequency, which is of course that of the received signal. Loose coupling partly aggravates this; but, for

FILTERING THE A.F. END

Every precaution has been taken with the set to preserve the signal in preference to the static, at the R.F. end; the same must be done at the A.F. end. A means of doing this is shown in Fig. 4, which shows a tuned choke or trap filter. With the constants specified, only the frequency to which the trap is tuned, about 500 cycles, gets satisfactorily past to the amplifying transformer. Others are shorted mainly through the trap and avoid the transformer. The odd and indifferent static discharges are thus reduced below their usual volume; while the average C.W. note may be adjusted properly for effectiveness.

Beyond this we cannot go, except to multiply our traps by using more audio amplification and repeating the trap in each stage, as shown in Fig. 5. While this proves very effective for telegraphy, it becomes both cumbersome and expensive when carried out to any considerable extent. The "ham" who is after the most effective way to improve his receiver at minimum expense, however, will not neglect an opportunity to install traps of the type shown.

Details for a home-made inductance coil of the correct size are shown in Fig. 6; the coil is wound with 2300 turns of No. 33 enameled wire. The air gap is necessary to preserve the inductance at the proper value, one henry. The usual transformer iron is used in the core. Two of these, and two fixed condensers, will make a pair of first-class traps in a two-stage amplifier.

FOR THE BROADCAST FAN

Of course, it is obvious that the connections outlined already are useless to the broadcast fan. "Music," consisting entirely of 500-cycle effective reproduction, would be only noise. This washes from our slate one of the most effective means of bettering the signal-to-static ratio. Yet the fight must go on.

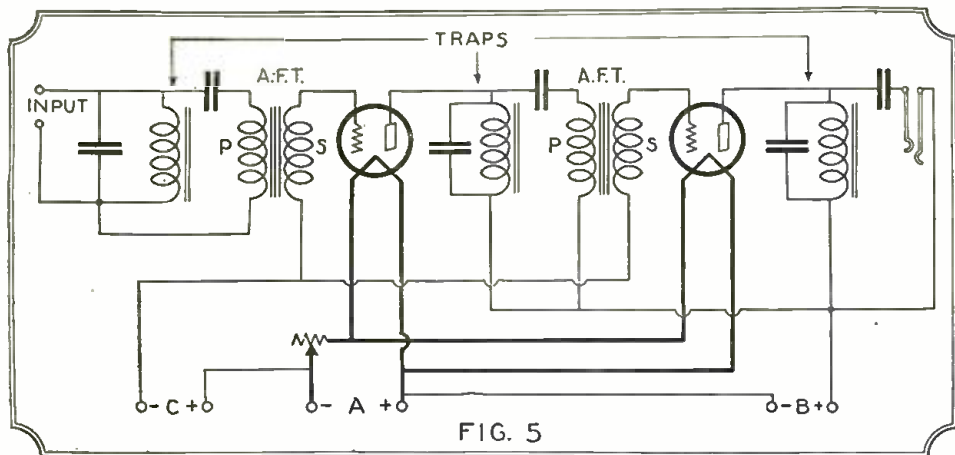
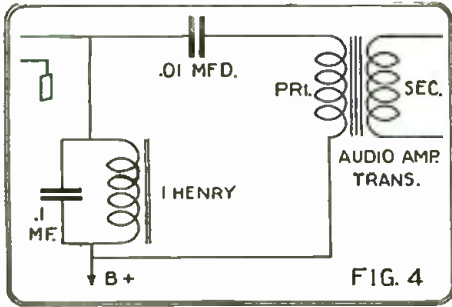

FIG. 5
By incorporating traps in the A.F. amplifier, as well as the R.F., the static annoyance is greatly alleviated.



Static must be reduced in the A.F. as well as the R.F., amplifier. Here is one method.

There is the old, and well known, scheme of a crystal detector connected between antenna and ground, across the terminals that serve as input connections to the set, as shown in Fig. 7. What happens is merely a reduction of the peak discharges to prevent the exceedingly heavy crashes that now and then dull the sensitivity of the ear. This at times creates a very satisfactory illusion of bettering the signal-static ratio, but at others seems to have no particular effect. Briefly, its theory is that the "square-law" response of the detector in the antenna circuit wastes a lot of energy in the peak discharges, as it would if the resistance dropped in geometric progression; but the lower signal voltage is very little affected. In practice it seems that this happens.

There is much said in favor of the loop as a means of improving the ratio. The recommendation is generally to obtain increasing sensitivity in the receiver by the use of R.F. amplification on the waves which permit it directly; or of the super-heterodyne R.F. amplification for the shorter wave-lengths. Practically, the gain through the use of the loop is not appreciable, for the increased sensitivity of the receiver seems to bring the static up to its usual level. There is no apparent discrimination between static and signal in the receiver itself.

UNDERGROUND ANTENNA IS EFFECTIVE

If the loop fails, there is one thing which does not, if one is in a situation to use the device, and that is the underground antenna. In some of the worst possible weather a good underground antenna will register no extraneous disturbance. It should be both long and well-insulated. One consisting of the ordinary rubber-covered wire can be used for a short time, but the covering will deteriorate and become very unsatisfactory.

A more thorough job is done by using a garden hose, with thick walls and good rubber, with the end sealed, as shown in Fig. 8. Such an installation will last a very long time. Permanent underground antennas may be installed in tile conduits, or in metal pipe, buried two feet to six inches under the surface of the earth. The ideal underground antenna system must be a radial one, since the antenna is directional lengthwise.

A single wire may be installed, with a right-angle turn, to permit of more general reception than is possible from one running in only one direction. Of course, the underground antenna does not pick up as well as the aerial, but this may be made up by amplification, very profitably. It is most uncanny to find very mild static, excellent signal strength and very pleasing reception in the midst of a thunder storm; yet it is possible with the underground antenna.

This system is impracticable, however, for most of the experimenting broadcast fans; and it is doubtful to what extent they can make use of it, particularly in the case of the large installations which are necessary for reception on the long wave-lengths.

SETTING STATIC TO "BUCK" ITSELF

For the average fan, a number of things may be suggested as worthy of experiment. One static "eliminator," which is as nearly

satisfactory as any, uses a transformer with a double primary winding, connected to a double detector system. The latter is coupled to a single antenna, so that one detector is tuned to the desired signal *plus* the static, and the other to the *static* without the signal. The primary windings of the double transformer are connected to oppose each other. The result is a reduction of the static, which comes in equally on each opposing primary, but no great effect upon the signal, which comes in only on one primary, and thus is put through to the amplifying tube or tubes to the desired volume. The general scheme is shown in Fig. 9.

In general, this system has proved very unsatisfactory, because the direct current through the transformer windings results in too great magnetic inertia. The proper method of connecting the balancing transformer for the most satisfactory effect is shown in Fig. 9-A. It is unfortunate that a specially-wound transformer is necessary. There are many schemes of the same general nature, designed to balance equal and opposing, and consequently self-cancelling, statics;

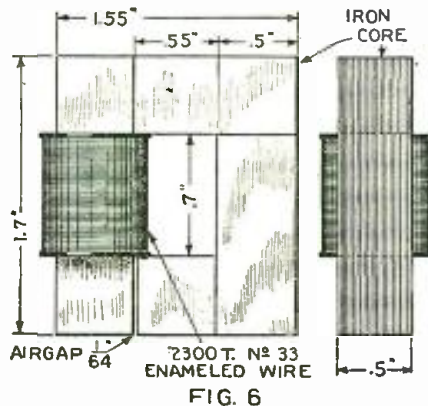

Here are shown details for a home-made choke coil, that can be shunted with a condenser, as shown in Fig. 4, for a filter.

while permitting the signal to go in from one side unchecked. In the main, these are quite useful if one is not deterred by the expense.

EFFECT OF LONG, LOW ANTENNA

Other things often suggested are simple tricks, of varying degrees of value. A long, low antenna is often a very satisfactory reducer of interference and static; and a short high antenna is often said to be of similar merit, in comparison with a long one of the same height. From the writer's experience, he cannot agree with this latter assumption, except in the case of the set which (as the average one does) makes no allowance for different antennas, and must be fitted with one according to location, weather and other variables. The low antenna, however, with any set capable of taking full advantage of

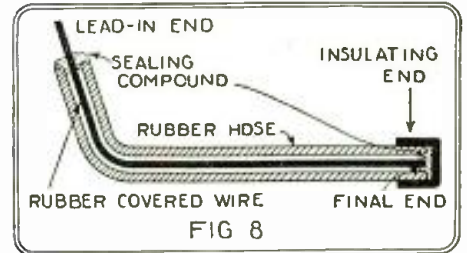

The use of an underground antenna (details shown above) prevents excessive static from drowning signals.

it, has invariably resulted in some improvement of the signal-to-static ratio. This is aside from the well-known Beverage antenna; and being shorter than the latter, it is less directional. Briefly, double the former antenna length at about half the former height is a practical dimension; although even greater length is preferable if the height is reduced a half. The set used on such a long, low antenna should have an antenna circuit tapped to allow for coarse tuning, and a coarsely adjustable degree of coupling between the former and the tube circuits. This paragraph is intended to place emphasis on the merit which, in the writer's opinion, the longer and lower antenna has in these respects.

USE OF BALANCED CIRCUITS

Other ideas for alleviation of static are based on similar principles to those explained above. In the Wheatstone bridge circuit (Fig. 10) a current from X to Y will not affect the indicator, I, if the two paths indicated by the resistance symbols are equal and proportionately divided. Although the radio circuits are less simple, the principle is the same. In Fig. 10-A we have a doubly-branched circuit with opposing E.M.F.s. passing through the two halves. If the paths provided are equal in impedance, the two forces will cancel, and nothing will appear across the indicator, I, as before. Most anti-static schemes have employed this principle in various ways.

One practical scheme of balancing suggested, that of Fig. 11, is obviously for a

(Continued on page 260)

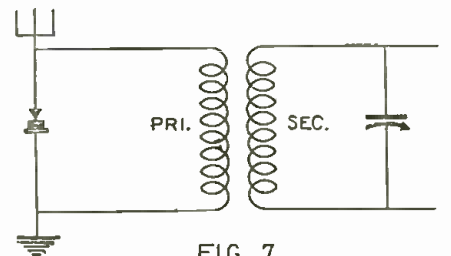
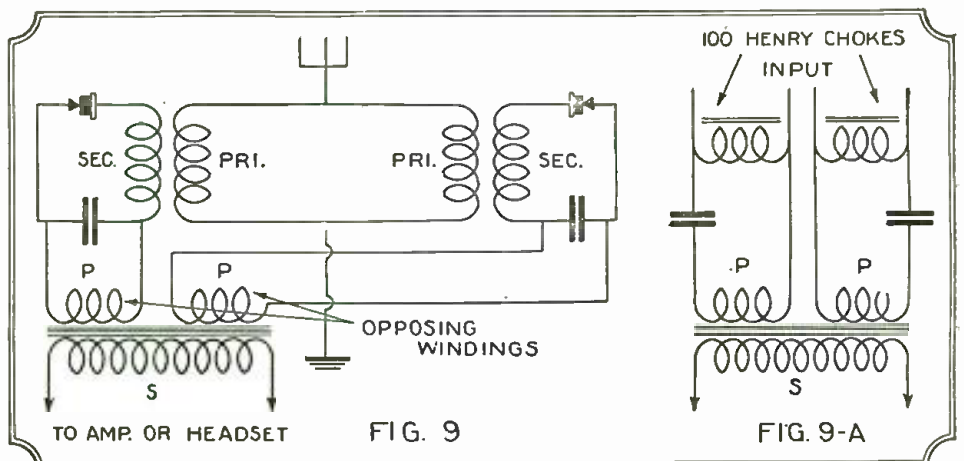

FIG. 7 This use of a crystal will reduce the peak discharges and prevent the heaviest crashes in the phones.



By a "bucking" system, employing two crystal detectors, as shown above, static can be greatly reduced, due to the opposing windings of the inductances in the antenna circuit.

Overloading the Audio Amplifier

By SYLVAN HARRIS

Continuing the series by Mr. Harris, this article discusses some of the conditions that are met in the design and operation of audio-frequency amplifiers. The salient point here expressed is that, contrary to the general assumption, audio amplifiers do not work into open circuits, but into surprisingly low impedances.



WHEN this series of articles on audio amplifiers was begun the writer did not stop to think how complex it would turn out to be. The study is leading us into many questions which have never occurred to us before; this is just as well, however, for the research is turning out to be very interesting, and very much worth while.

The readers of this series of articles (of which this is the fourth) may be beginning to wonder: "When are we going to read about the construction and design of amplifiers?" It is probable that the study of the characteristics of the different kinds of amplifiers will be begun in the next issue of RADIO NEWS.

But, before discussing the amplifier characteristics, it is necessary that we should completely understand what is required of an amplifier and what difficulties we may meet, in both its design and its operation. It is for this reason that we have discussed at such length the subjects of overtones or harmonics, distortion, means of illustrating the characteristics, etc., in our previous articles. In this article we will discuss the causes of overloading the amplifier, the

ered more in detail later on when we discuss the amplifier circuits themselves. It is necessary to introduce the subject beforehand in order to make the following article intelligible.

INTERNAL CAPACITY OF A TUBE

To begin, then—let us look at Fig. 1. Here we have two electron tubes coupled by an amplifier coupling device, which may be an audio transformer, or a network of various

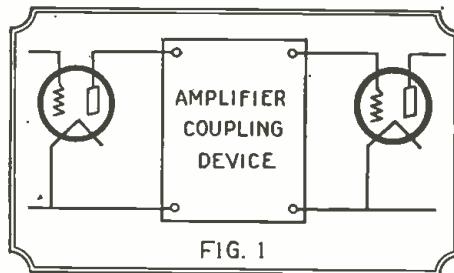

FIG. 1
An amplifier coupling device is connected at its input side to the impedance of the plate circuit of the tube preceding; on its output side to the impedance of the grid circuit of the succeeding tube.

shown (ibid.) that this capacity is not the simple electrostatic capacity existing between the filament and grid, but is much greater; as the capacity existing between the grid and plate and that between the plate and filament have an effect on the input capacity. The idea is illustrated in Fig. 2A and the equivalent electrical network in Fig. 2B. The voltage μe_g shown in Fig. 2B is the voltage developed in the plate circuit of Fig. 2A by an alternating input voltage e_g .

FORMULA OF INPUT CAPACITY

If the capacity of the network be measured between the points a and b (Fig. 2B), the apparent input capacity of the tube will not be merely C_1 but will be

$$C_x = C_1 + C_3 \left(1 + \frac{\mu r_p}{r_p + r_o} \right)$$

in which C_x is the apparent input capacity, C_1 is the grid-filament capacity, C_3 is the grid-plate capacity, μ is the voltage amplification constant of the tube, r_p is the plate resistance of the tube, and r_o is the resistance of the load in the plate circuit. This load is not shown in the figure; in a resistance-coupled amplifier r_o would be the resistance connected between the plate and the "B" battery; in a transformer-coupled amplifier it would be the resistance (not impedance) of the transformer.

Now, to investigate the magnitude of this input capacity for the UX-201A tube, the

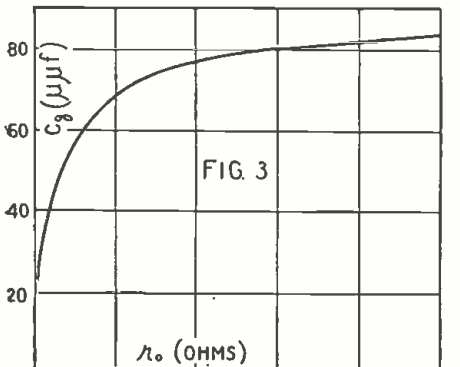

FIG. 3
The input capacity of a tube depends on the resistive load in the plate circuit. How it varies with this resistance, for a 201A tube, is shown in this curve.

effect of this overloading on the quality of reproduction, and consider somewhat the nature of the load as it affects the output of the amplifier coupling device.

The last subject will be dealt with but lightly in this article, for it will be consid-

combinations of resistors, condensers, and impedances. The action of the complete amplifier is so complicated that, in order to simplify the problem, assumptions are generally made on the basis of ideal operation. To be specific, since in the ideal electron-tube repeater (or amplifier) no current is supposed to flow between the grid and filament of the tube, it is supposed that the input impedance of the tube is infinite.

In general, the grid of the tube is made sufficiently negative, by means of biasing batteries, so that no convection current flows between the grid and filament. This biasing does not, however, prevent the flow of alternating current through the condenser formed by the grid and the filament. In other words, the grid and filament can be considered as two plates of a condenser; and it is well known that current will flow through such a condenser when an alternating potential, such as the signal voltage, is impressed across its terminals.

It has been shown (J. M. Miller, U. S. Bureau of Standards, Scientific Paper 351) that the input impedance of an electron tube may be represented by a capacity in series with a resistance. Furthermore, it has been

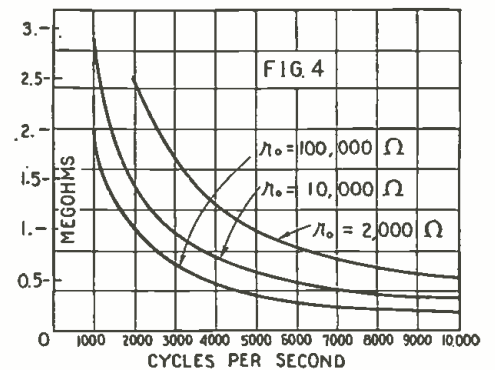

FIG. 4
This curve shows how the reactance, due to the input capacity of a tube, varies with the frequency, for various resistive loads in the plate circuit. Note that over the most important part of the acoustic-frequency range, the reactance may be less than one megohm.

following constants have been assumed for the sake of argument:

- C_1 10 μf .
- C_3 10 μf .
- μ 7
- C_p 10,000 ohms

These values are likely to vary in different tubes, and with different plate voltages; but they will at least give us a fair idea of the magnitude of the input capacity, when substituted in the expression given above. From these values the curve of Fig. 3 was computed for different values of load resistance, varying from zero to 100,000 ohms. The latter value of the resistance is probably the greatest that is used in resistance-capacity-coupled amplifiers; and of course zero resistance is much lower than the resistance of transformers. It is evident, then, that this curve covers all practical cases for the tube in question; and it shows that the input capacity may be as high as eighty micro-

(Continued on page 288)

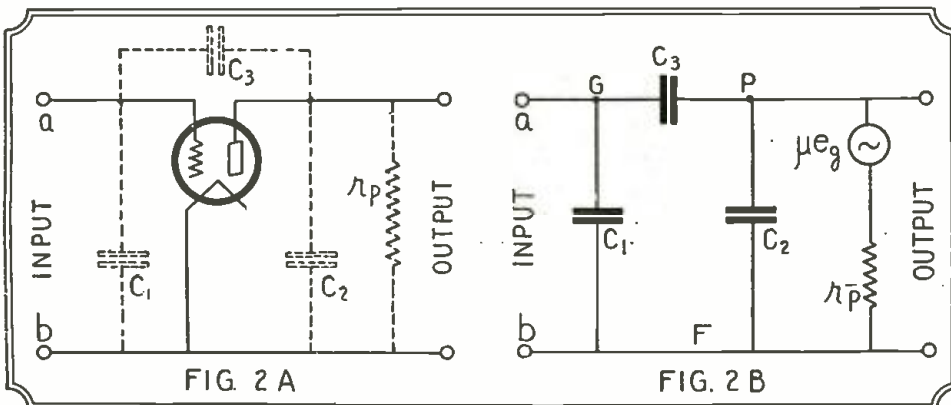

FIG. 2 A
FIG. 2 B
The circuit of an electron tube may be represented as a network composed of resistances and capacities. C_1 is the grid-filament capacity, C_2 the plate-filament capacity, C_3 the grid-plate capacity, r_p is the internal-output impedance (or, simply, the plate resistance of the tube), and μe_g is the emf developed in the plate circuit by the alternating voltage on the grid.

A Plug-in-Coil Short Wave Receiver

By A. P. PECK

Real low-loss construction, convenient placement of parts and an easily accessible coil mounting are features of this multi-wave short-wave tuner.

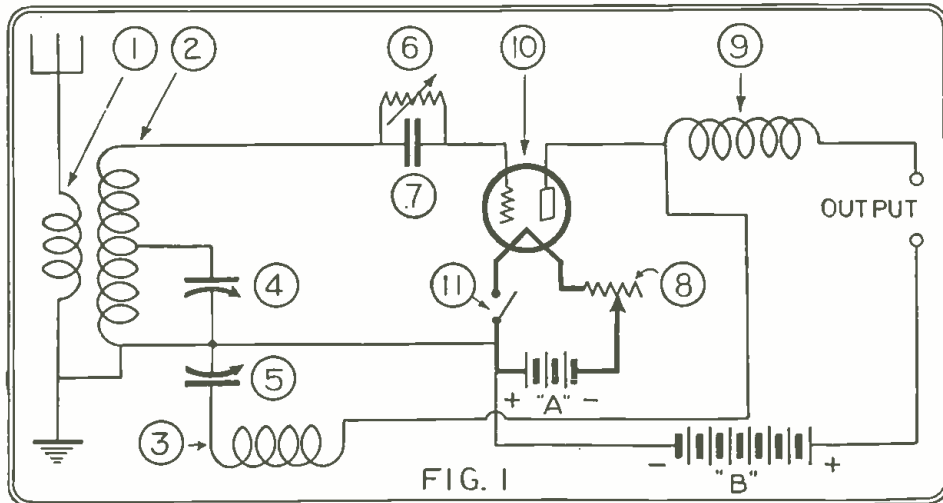

FIG. 1
Circuit diagram of the interchangeable-coil short-wave receiver. The parts are numbered in correspondence with the apparatus shown in the lower illustration.

FOR a good many months, the writer has been building and testing various types of short-wave receivers in an endeavor to ascertain the best possible way of making a set of this nature, that will yet be simple in construction and that the average ham can build without the least bit of trouble. Of the several types made and used, that described in this article and illustrated here is the one, using home-made coils, which seems to give the very best all-around results. There are several desirable features incorporated in this set, and among them are the following:

Absolute freedom from body capacity: this is obtained by placing both variable condenser rotors at ground potential, as can be seen from the circuit diagram (Fig. 1).

Low-loss construction: the coils have a minimum of dielectric in their fields and they are spaced well away from the variable condensers, so that the fields of the coils will not interact with the metallic parts of the condensers.

Ease of tuning: one tuning control and one regeneration control are all that are employed.

Stability of operation: once the variable grid-leak is adjusted, and the operator learns how to tune the set, he can always set it at any desired wave-length without any trouble whatsoever, and be sure that the set is operating at its best.

Ease of construction: the coils, about the best that can be built, are very simple to make.

Flexibility: several sets of coils can be made up to cover all the amateur wave-length bands.

It will be noted in this article that no definite data are given, relative to the various sets of coils to be employed. This is because these are more easily ascertained by the builder after the set has been placed in operation. Each variable condenser employed will require a slightly different secondary coil and, therefore, the experimenter can go right ahead and work out the constants for coils to be used with the particular type of variable condenser that he employs.

coils held in place by the binding posts are designed for use on the 40-meter amateur band. In actual practice, the tuning range of the set with these coils is from 32 to 48 meters. This band is spread over 100° on the dial; and it is therefore obvious that the various stations received will be spaced quite far apart and the result will be less jamming of signals. One of the coils shown, No. 1, consists of 4 turns wound in haphazard fashion and bound together with thread. This is the primary or antenna coil. The other coil made in the same manner, using 6 turns, is the plate coil, No.

3. No. 14 D.C.C. wire is used for all inductances. Since low loss is not a necessary feature in the antenna and tickler circuits, it is entirely possible to wind the coil in the bunched fashion shown without detracting from the operating qualities of the set.

In the secondary coil, however, low-loss construction is quite necessary and entirely desirable. Therefore, the coils were wound in the special form shown, No. 2. It will be noted that the turns are spaced and the distance between each turn should be approximately equal to that of the diameter of the wire. Even slightly greater spacing will not do any harm; but it will reduce the total inductance value and, therefore, another turn or two may be required. For the 40-meter band, with the five-plate tuning condenser illustrated, 7 turns were used on the secondary and the coil was tapped at the fifth turn from the filament end. The method of tapping was merely to scrape the insulation from the wire at the point where the tap was to be fastened, and then solder a short piece of bare wire to this point. The reason for this tap is so that the tuning band could be spread out further on the dial. It is very advisable to experiment with the exact location of this tap until the wave-length band to be tuned in is located in the desired position on the dial.

From the data given for the 40-meter band, the necessary number of turns for the other bands can easily be worked out. For the 20-meter band, use approximately half the number of secondary turns necessary for the 40-meter wave, and only 3 turns in the antenna circuit. Reduce the number

(Continued on page 290)

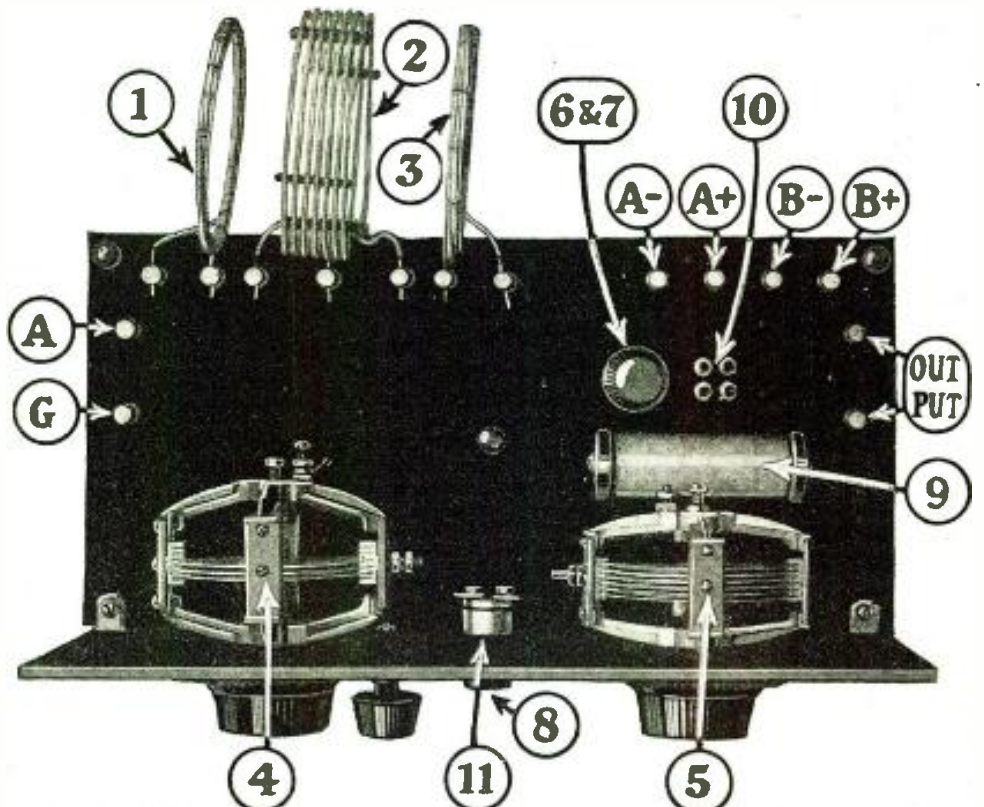

Top view of the completed short-wave receiver. The parts are: 1, antenna coil; 2, secondary coil; 3, plate coil; 4, .000125- μ f. variable condenser; 5, .00025- μ f. oscillation-control variable condenser; 6, variable grid leak; 7, .00025- μ f. grid condenser; 8, rheostat; 9, R.F. choke; 10, detector and 11, "A" battery switch.

SELF-SUPPORTING COILS

Referring to the illustration shown, the



First Prize

IMPROVING THE SINGLE CIRCUIT

By DAVID JENKINS

In spite of the campaign against the single-circuit tuner, there are still many in use and there are several makes yet on the market. Besides radiating easily and causing interference with other sets, they do not usually tune sharp enough to eliminate unwanted stations. Various ways of stopping this by changing the set to the so-called three-circuit have been published, but these usually require changes inside the set. Here are shown two methods of changing a single-circuit to a three-circuit, without tampering with the inside wiring at all.

Fig. 1 shows the simplest way and prob-

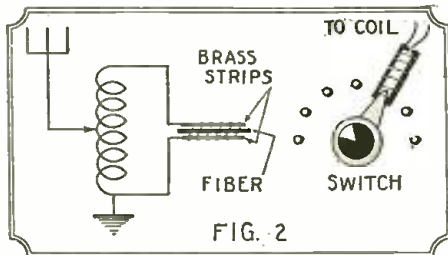

Details and connections for the contact strip which is placed between the switch blade and one of the points.

ably the best. The antenna is disconnected from its terminal and the antenna and ground terminals are connected by a short piece of wire. This shunts the variable condenser across the tapped inductance. The inductance switch is usually so connected that turning it to the right increases the number of turns of wire in the circuit. The setting of this switch must be found by trial but it will usually be at about the fifth tap from the left, and cut in about fifty turns. A piece of flexible wire (tinsel cord) is connected to the antenna lead-in wire and a small brass clip is soldered to the other end of the flexible wire. This clip is to connect with one of the switch points and should usually be clipped on the first switch point to the left of the switch lever. This will put about ten turns in the aerial-ground circuit, which will make it similar to the Haynes circuit.

Another method which employs an external coil is shown in Fig. 2. The coil used has thirty turns, tapped every five turns. A piece of thin fiber or cardboard, with a thin brass strip held on each side with thread,

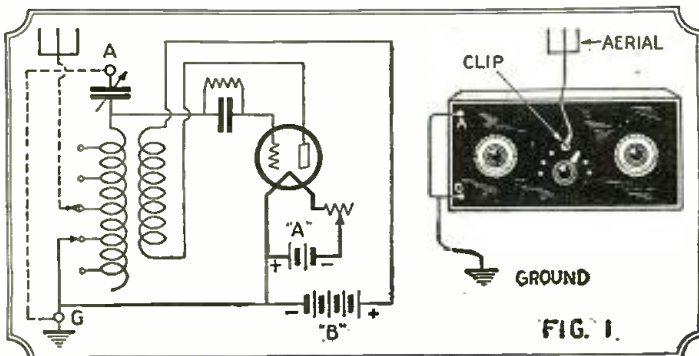

The circuit arrangement for the single-circuit receiver. It will be noted that the aerial and ground posts are connected together and the aerial attached to the contact strip.

Prize Winners

First Prize \$25

Improving the Single Circuit

By DAVID JENKINS

410 Washington St., Xenia, Ohio

Second Prize \$15

An Easily-Made Trouble Finder

By ARNOLD D. FINLEY

429 Broadway, Somerville, Mass.

Third Prize \$10

Plug-In Coils for All Waves

By R. F. STARZL

Box 347, Le Mars, Iowa

All published Wrinkles, not winning prizes, will be paid for at the rate of two dollars each.

The next list of prize winners will be published in the November issue.

is made so that it will slip under the switch blade, with one brass strip making contact with the switch point and the other strip making contact with the switch blade. Pieces of tinsel cord are soldered to each of the brass strips. Each cord is connected to one end of the coil, placing the coil in series with the coil in the set.

Second Prize

AN EASILY MADE TROUBLE FINDER

By ARNOLD D. FINLEY

The writer had seen various constructional articles on radio trouble shooters, but most of them called for expensive apparatus to complete the unit. They were no doubt excellent trouble shooters, but he could not see spending eighteen dollars or so when more than likely the device would not be used enough to warrant the expenditure.

It appeared that one should be able to build a good trouble shooter, at a comparatively low cost, which would be accurate enough for most cases. Finally the writer designed one which, as it happened in his case, cost nothing at all. If your junk pile

is any good at all this outfit need not cost you more than a dollar; but even if you have no junk pile, and have to make or buy every part, the total cost should not be more than \$2.50.

The panel layout (Fig. C) shows a standard galvanometer used as an indicator; but later on we shall find that a good indicator can be made from a fifty-cent pocket compass.

The following list of parts includes the pocket compass. If you wish to use a standard galvanometer the cost will be from seven to nine dollars more.

- 1 4 by 5½" panel.
- 1 Single-pole single-throw switch (panel size).
- 1 Single-pole double-throw switch (panel size).
- 4 Binding posts.
- 1 1½-volt flashlight lamp.

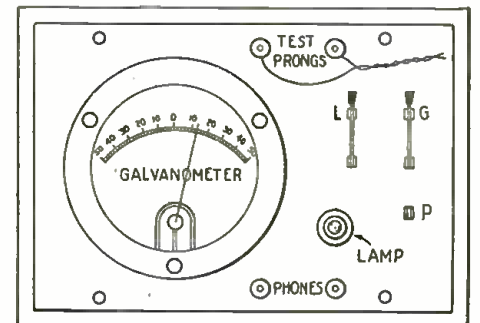
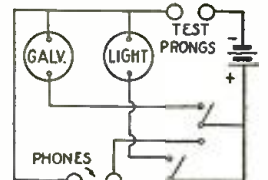

Details and diagram of the Trouble Finder. The galvanometer made from a compass is shown at Fig. A.

- 1 1½-volt flashlight cell (flat type preferable).
- 1 Porcelain lamp socket.
- 1 Pocket compass (light weight and one that swings easily).
- 4 Wood screws.

Cabinet, size of panel and 3½" deep.

To make the galvanometer, wrap a thin piece of cardboard half an inch wide around the compass as shown in Fig. A, and on it wind a few turns of No. 35 or 38 S.C. wire. The exact number of turns will depend on the resistance of the phone or loud speaker which you will probably want to use in this test circuit. The writer used ten turns of No. 40 wire. The connections are taken from the ends of this coil, and the instrument is connected into the circuit as shown in Fig. B, so that it can be placed in series with the flashlight battery and test prongs by closing the L switch.

The diagram shows the position of the parts on the panel quite clearly. The galvanometer is centered 2 inches from the left

side and 2 inches from the bottom of the panel. The switches are placed $\frac{5}{8}$ - and $1\frac{3}{8}$ inches from the right side respectively. The center pivots of the switches are 2 inches from the bottom, but the remaining holes will have to be drilled for your particular switches. The light is $1\frac{1}{2}$ inches from the side and $1\frac{1}{4}$ inches from the bottom. The binding posts are $1\frac{1}{2}$ and $2\frac{1}{2}$ inches from the right side, and $\frac{3}{8}$ inches from the edge of the panel.

The flashlight cell is mounted on the inside of the cabinet by means of a piece of brass, bent to fit around the cell and fastened down to the cabinet.

All the connections are shown clearly in the wiring diagram of Fig. B.

Two test prongs should now be made, to attach to the two binding posts so marked. A section of braided lamp cord or telephone wire will do very nicely. Solder a section of bus-bar wire about 8 inches long to each of the wires. It is a good idea to wind some electrician's tape around a portion of the wire and the bus-bar to serve as handles.

Now let us see what this outfit will do. Space does not permit a complete treatise on trouble shooting; hence only the points which concern this instrument will be considered.

Testing Coils: With GP switch open and L switch closed, touch the terminals of the coil with the test prongs. If the lamp lights it indicates that the coil is not open-circuited. If the lamp fails to light there is an open circuit, probably a broken wire, and the coil should be re-wound.

Variable Condenser: Disconnect one of the leads to the variable condenser (if it is mounted in a set) and with the switches in the same position as mentioned above fasten the test prongs to the two condenser connections. Slowly rotate the plates of the condenser through the full 180 degrees. If at any point the lamp lights there is a short circuit, indicating that one or more of the rotor plates touch the stationary plates. It should be easy to find at what point or points they touch. They can be bent back into their proper position with a screw driver.

Fixed Condensers: With the switches still in the same position touch the test prongs to the two condenser terminals. The lamp should not light if the condenser is all right. If the lamp does light the condenser is shorted and should be replaced.

Phones or Loud Speaker: Open the L switch and close the GP switch at G. Touch the terminals of each phone separately and watch the galvanometer closely. If the fine wires composing the electromagnets in the phone are unbroken, there should be a noticeable deflection of the galvanometer needle. If, with either phone there is no such deflection, then the phone must be repaired or replaced. After this, the phones should be tested together, by touching the test prongs to the phone tips. There should be a deflection of the galvanometer needle in this case also, providing the phone was found OK on the previous test. If there is no deflection, the phone cord is defective and must be replaced. A loud speaker is tested in the same manner as a single head-phone.

Noisy Batteries: With the L switch open and the GP switch at P, put the phones in at the posts marked "phones." Now touch the terminals of the battery to be tested with the test prongs and listen in the phones. There should be one loud click and no more. If intermittent noises are heard it is a sure indication that the battery is in a state of deterioration. In making this test, be sure that the test prongs make perfect contact with the terminals of the battery, and that the phones make good connection with the binding posts.

Any portion of a circuit can be tested

for an open circuit with this trouble shooter by placing the switches in the positions indicated for testing coils. If the circuit under test is OK, the lamp will light. If there is a poor connection in the circuit the lamp will flicker.

Third Prize

PLUG-IN COILS FOR ALL WAVES

By R. F. STARZL

After constructing several so-called all-wave receivers, the writer has decided that the best way to cover all wave-lengths, without an attendant loss of efficiency, is by the use of removable coils, covering comparatively narrow bands of wave-lengths. About eight such coils will cover a range of from 10 to 1500 meters.

The same object can be attained by using a large tapped coil; but experience shows that a large number of dead turns in the vicinity of the active turns cause considerable losses on the short waves. There is also the difficulty of maintaining and controlling regeneration.

All this difficulty is obviated by use of the interchangeable coils. Plug-in coils can be easily and cheaply made as follows:

Procure a cardboard ice-cream carton or similar container. Around the edge of the carton bend small strips of hard copper to form contacts. Wind the coil on the carton and pass the ends of the wire through small holes, and thence to the copper strips, where

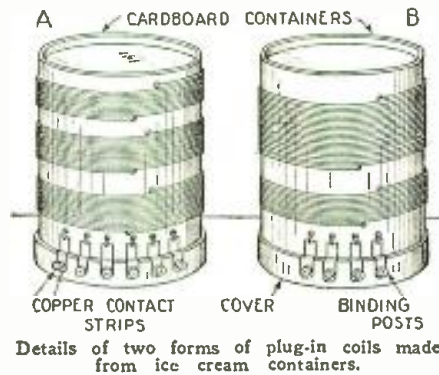

Details of two forms of plug-in coils made from ice cream containers.

they should be soldered. This is enough to hold the strips in place.

Now take the cover of the ice-cream carton and fasten copper strips on the outside edge, so that they will coincide with the strips on the edge of the carton, bending them in and fastening them with small binding posts or bolts. The cover should be fastened to the baseboard of the receiving set with two wood screws.

Make coils to cover the wavebands desired, placing the contact strips in exactly the same position as on the first coil.

The accompanying illustrations give all the necessary details. A shows a coil designed for a three-circuit regenerative receiver. B is one of three coils designed for use in a tuned-radio-frequency set. In this case three covers would be required.

A USEFUL SOLDERING KIT

This consists of a baseboard about four by eight inches, upon which is mounted a block of lump "sal ammoniac," or ammonium chloride, a can of soldering paste, and a support for the soldering iron while it is being heated, assuming of course, that an electric type of iron is being used.

The block of ammonium chloride (sal ammoniac) is used to tin the iron. The iron is rubbed into the cake, upon which several drops of solder should be placed, and frequently touched to the drops of solder which become molten and flow over the surface of the iron, forming a very good coat of tin. The paste is used to apply to the

parts to be soldered. You can make your own paste by rubbing up sal ammoniac with vaseline. A bit of powdered resin can also be added.

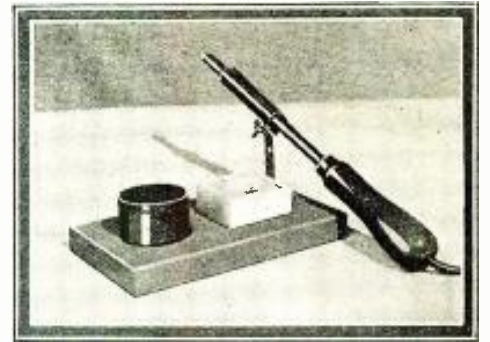

A simple soldering kit mounted on a thick wooden base.

The support for the soldering iron is made from one of the brass brackets which can be had from the corner radio store. Look their parts counter over. A short L-shaped bracket can be screwed to a long L-bracket, bending with the pliers at the right spot to form a V crotch in which the iron rests.

Contributed by Raymond B. Wailes.

KEEPING THE HYDROMETER CLEAR

We all have had the experience that, after taking a number of readings with a hydrometer, the glass barrel becomes clouded due to the accumulation of numerous fine particles of electrolyte on the inside of the glass. If this is allowed to go on for some time it becomes very difficult to make out the reading on the float; yet it is a messy job to take the hydrometer apart and wipe out the inside.

A very simple way to overcome all this is to purchase a 6-ounce bottle of denatured alcohol and, after taking a reading, insert the nozzle of the hydrometer into the bottle of alcohol and allow the barrel to fill up. Upon squirting the alcohol back into the bottle the barrel of the hydrometer will be found perfectly clear. The same alcohol can be used indefinitely.

Contributed by Alfred Taylor.

MAKING A GOOD GROUND CONNECTION

The ground connection is a most important factor in the correct operation of a receiving set; yet many people fail to make a good one. An excellent ground connection may be

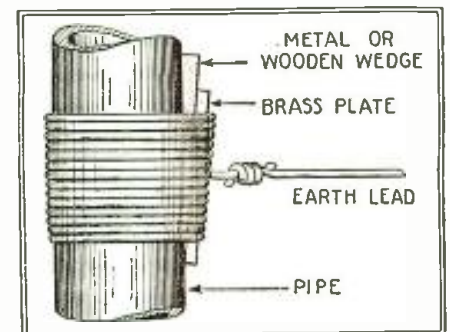

A good ground connection can be made by winding wire around the water pipe and driving in a metal wedge to make the wire taut.

made in the manner shown in the accompanying sketch. The pipe to which the connection is to be made should first be thoroughly cleaned for a space of one or two inches. Around this section should be wound

(Continued on page 278)

Radiotics

MANY LONG YEARS AGO

Historical statistics from *Des Moines Tribune* of May 29: "Radios were in every fifth home by January 1925." You've all heard about good King Canute and the sea-waves? Well, maybe historians made a mistake and it was really the air-waves that Canute tried to get rid of.

Contributed by Jack Doherty



GRACIOUS, WHAT NEXT?

A smooth advertisement from the *Oil City (Pa.) Derrick* of June 14: "A ONE TUBE RADIO HEAD-SET; batteries complete, \$10." Evidently these head-sets are for receivers that have insufficient amplification. It is predicted that they will have a great sale among crystal set addicts.

Contributed by H. W. Stingluff.



CHEAP AT HALF THE PRICE

Real estate gesture from the *New York Sun* of May 29: "Radiola super-heterodyne portable for sale, complete with HOME and portable batteries." There's no price mentioned, but whatever it is, it would be cheap. This is an excellent opportunity for newlywed fans who wish to settle down.

Contributed by B. Murphy.



USE FOR OLD TUBES

Expert advice from the *Boston Traveller* of June 5: "A DEFECTIVE tube in the R.F. amplifier would INCREASE the range of your receiver appreciably." Now, instead of using your old tubes to heave at yowling cats on the back fence, try this little stunt and let us know if it works.

Contributed by J. H. Payne, Jr.



THIS IS DEEP STUFF

Advance notice of an event that will doubtless cause a rush similar to the "49ers" to Calif., in the *Birmingham (Ala.) News* of May 23. "MINERS GET RADIO 2,100 FEET DEEP." This looks as if the manufacturers of sets will have to go out of business, if they can dig up receivers like this.

Contributed by Donald Ellis.



HAIL, HAIL, THE GANG'S ALL HERE!

Bright idea set forth in the June 2 issue of the *Pittsburgh Post*: "Each set of inductance is CELEBRATED so that accurate tuning may be made." Our guess is that a few coils have been named for Marconi, Hertz, de Forest, Armstrong, etc., and that they make a great combination for DX receiving.

Contributed by C. F. Neumann.



TRY THIS ANTENNA

Prickly advice dispensed by *Everybody's Radio Weekly* of March 6: "Under no condition should the BARB wire touch any part of the building," this in describing an antenna. We suppose that the barb wire is used to thoroughly entangle the elusive waves.

Contributed by E. C. Dymond



IF you happen to see any humorous misprints in the press we shall be glad to have you clip them out and send to us. No RADIOTIC will be accepted unless the printed original giving the name of the newspaper or magazine is submitted with date and page on which it appeared. We will pay \$1.00 for each RADIOTIC accepted and printed here. A few humorous lines from each correspondent should accompany each RADIOTIC. The most humorous ones will be printed. Address all RADIOTICS to

Editor RADIOTIC DEPARTMENT,
c/o Radio News.

NICE AND FLEXIBLE, TOO

Under the head of "Simplifying Radio" in the *Springfield (Mass.) Union* of June 17 we find this beauty: "Fifty feet of wire—hung vertically from a WOOLEN pole..." Oh, Grandma, will you please knit me a new mast for the coming winter? The moths got in the one on the roof and my aerial is down.

Contributed by Dr. Hugo S. Thomson.



A SPANISH TYPE?

Rasco advertisement, tracking of toreadors, mantillas, etc., from *Science and Invention Magazine*, July, 1926: "Push-BULL Transformers, ratio 6 1/2 to 1, \$2.95." We assume that our eminent colleagues had in mind some relation between the great pep exhibited by these transformers and the rush of the cow's husband.

Contributed by Fred Shuster.



ANTI-VOLSTEADIAN CONSPIRACY

On June 19 in the *Oklahoma City Times* there appeared this gem: "Three-tube Crosley Tri-dyne, special radio, WET HOOKUP. Loud speaker, \$40." Evidently this gent sees some connection between radio and licker, that up to the present has been very thoroughly hidden from us. Come on, give us a tell.

Contributed by R. C. McQueen, Jr.

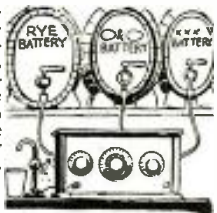

EASY AS PULLING TEETH

In *Radio Doings* of May 22 is this advice to experimenters, "You may find it necessary to reduce the number of TUNES in the plate circuit..." If you will wait around a few minutes we'll have the tunes removed from the plate circuit. Bill has gone after the extractor.

Contributed by H. Inwald.



HARD ON THE FINGERS

Splintery classified advertisement in the June 15 issue of *Radio Digest*: "200 ohm potentiometer with SLIVER knob and dial, 10 cents." This is a very cheap way of getting dials for the set. Just go to the nearest wood pile, grab a piece of timber and whittle out a snappy knob and dial. It's a cinch!

Contributed by Wm. G. Mortimer.



GO GET 'EM HAZELTINE!

Hefty wallop at the popular circuit in the *New York American* of June 3: "New Oscillator Ends Evils of NEUTRODYING." These crystals, that broadcast stations are putting in to stop heterodyning with other stations, seem to do many other things as well. The Hoboken Professor should go after the writer of that head.

Contributed by F. W. Farnam.



STOP THIEF!

Heinous crime reported in the *Portland (Ore.) News* of June 9. "Six large brass VOLTS valued at \$10 each were stolen from a box car." Will someone please go after the constable and the bloodhounds, and get on the trail of this radio fan who has stolen non-rusting volts for his "A" battery?

Contributed by L. M. Karr.



TRY A SET OF THESE

Intriguing advertisement in the June 20 *Times*, of Henry Ford's city: "Radio-Six aerial and horn, BUILT IN BEAUTIFUL CABINET." This bunch of aerials would be ideal for people who can not put them up outside. We suppose that they are for any old wave-length that might come along. Can we take your order?

Contributed by Chas. Ostaszewski.



DON'T LET NOTHING GO TO WASTE

Grand and glorious news from the *New York Daily Mirror* of May 31: "The Leakandenser may be used on the detector tube of all sets using a VACUUM as a detector." No more tubes to burn out, Oswald. You run right down to the store and get five or six vacuums. And, Oswald, don't spill any on the way back.

Contributed by Thomas F. Maher.



A CYCLONIC SPECTACLE!

Excitement in Chicago, seen by the *New York World's* special correspondent on June 18: "Every spoken word will be snatched up by the VOLTS and AMPERES and thrown over hundreds of acres. Besides this, microphones will be tapped onto radio circuits and go flying through the ether." The visiting Cardinals will have new American wonders to relate when they return to Europe.

Contributed by K. E. Crilly.



STANDARD HOOK-UPS

EVERY month RADIO NEWS presents in this convenient form a selection of circuit diagrams, with constructional and other data, on standard hook-ups, which the editors have tried and found to give excellent results. Every radio experimenter should preserve these for their reference value, as they are selected to cover the complete range of radio apparatus, from the simplest to the largest and most complicated. Requests for special or additional advice and information should be addressed to the I WANT TO KNOW Department of RADIO NEWS. (A charge of 25 cents is made for answering each question which requires a reply by letter.)

Handy Reference Data for the Experimenter

"A" BATTERY ELIMINATOR

Circuit No. 180. Many are undoubtedly desirous of constructing a battery eliminator which will provide sufficient current to light the tubes in their sets, thereby doing away with the care and trouble of storage batteries. There is presented here a practical "A" battery substitute, which may be easily constructed from parts readily obtainable in any electrical supply store. The essentials are as follows:

- 4 Step-down Transformers, of the type commonly used to operate toy electric trains, etc. (Their current consumption is approximately 75 watts);
- 2 Rectifying Tubes (Tungar 2-ampere type);
- 1 Choke Coil (wound with 1,800 turns of No. 18 D.C.C. wire on a laminated-iron core, six inches square on the outside, material 1 inch square);
- 3-By-pass Condensers, one 4- μ f., one 2- μ f., one $\frac{1}{2}$ - μ f.;
- 2 Power Rheostats, used in series, and miscellaneous.

The primary windings of the four toy transformers are all connected in parallel and lead to the light socket. As will be noted, two of them are employed to supply filament current to the rectifying tubes; the other two furnish the current which is rectified.

It might prove to greater advantage to use the tapped-secondary type of transformer to supply the filament current; by this means it is possible to control the current output of each tube, and thereby regulate the output of the eliminator as desired.

R. F. AMPLIFIER UNIT

Circuit No. 181. There are many experimenters who are desirous of increasing the selectivity and DX possibilities of their receivers, but who hesitate to rewire their sets and experiment with the different circuits which are offered from time to time. It is not necessary to make such drastic changes; as the R.F. amplifier unit diagramed may be added to practically any set of the "inductively-coupled" type, and will very satisfactorily increase both the selectivity and the distance range of the receiver.

By "inductively-coupled" we mean that no direct connection is made between the primary winding of the antenna coil, within the receiver, to either the grid or the filament circuits. The experimenter must make sure that his set is inductively coupled in this sense, before he attempts to construct and connect this unit.

The following are the parts necessary:

- 1 Low-loss Diamond-Weave Coil (primary and secondary windings), adapted to the capacity following;
- 1 Variable Condenser, .00035- μ f., preferably S.L.F.
- 1 400-ohm Potentiometer;
- 1 Vacuum Tube and Socket;
- 1 Rheostat (30-ohm type for -199 tubes.

20-ohm for 201A or 301A tubes), and miscellaneous.

This unit is very "flexible": that is to say, it may be connected to or detached from the receiver with the greatest ease. In order to connect it, it is necessary only to connect the regular antenna and ground to the primary winding of the coil employed (which should be equipped with two binding posts so that this is but a matter of a few seconds) and connect the output of this amplifier stage to the "ground" post of the receiver; joining the "antenna" post of the latter also to

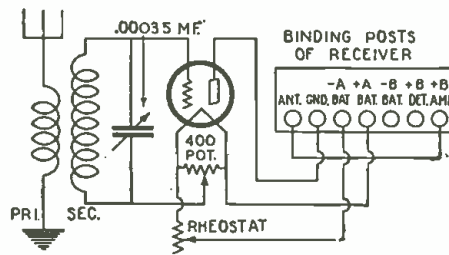

(181)

The method of connecting a one-stage radio-frequency amplifier unit to any receiver of the "inductively coupled type." This will increase both selectivity and sensitivity.

the B amplifier, as shown, with a "jumper."

The "A" and "B" battery connections to the amplifier stage may be retained permanently, simply turning off the rheostat when it is not desired to use this stage; and disconnecting the output leads from the "A" and "G" posts of the receiver. The latter are readily reconnected to the antenna and the ground, to use the set without the amplifier.

LOW-POWER TRANSMITTING SET

Circuit No. 182. So much interest has

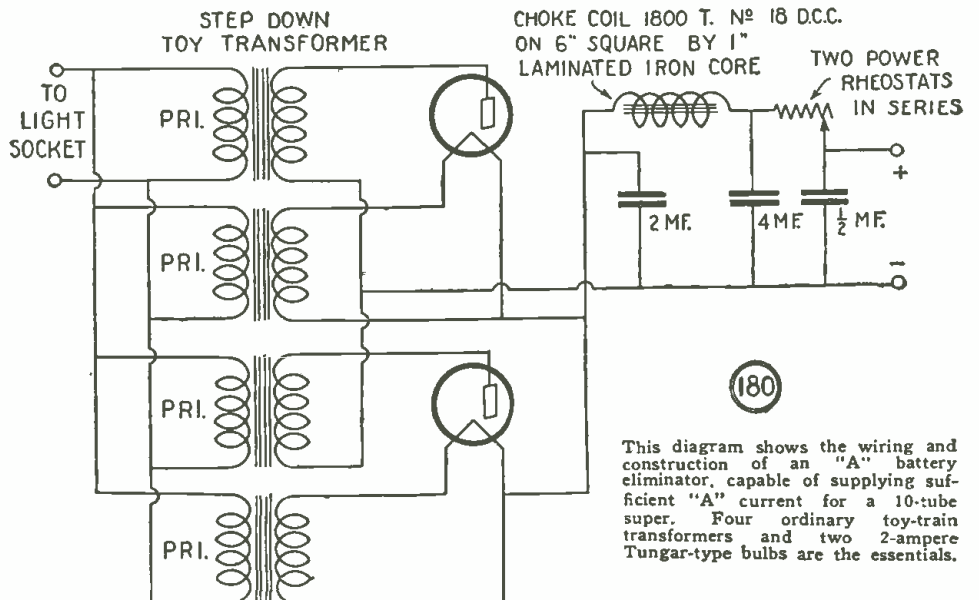

(180)

This diagram shows the wiring and construction of an "A" battery eliminator, capable of supplying sufficient "A" current for a 10-tube super. Four ordinary toy-train transformers and two 2-ampere Tungar-type bulbs are the essentials.

been expressed lately on the subject of short-wave, low-power transmission, and so many requests have been received by the "I Want to Know" department of RADIO NEWS, for an efficient transmitting circuit which will comply with the requirements of the law—that, rather than answer individually each letter, we present here a transmitter which will, we are sure, satisfy the most exacting requirements, and delight the most critical constructor.

For best results, it is advisable to employ only material which has been especially designed for transmitting purposes. Instruments chosen and connected haphazardly are certain to be disappointing; for only inconsistent and unsatisfactory results will be obtained.

The following apparatus is required for the construction of this transmitter:

- 3 Variable Condensers, transmitting type, .0005- μ f.;
- 4-By-pass Condensers, .002- μ f.;
- 2 R. F. Choke Coils (which may easily be constructed by winding 200 turns of No. 28 or 30 D.S.C. wire on each of two 1-inch tubes);
- 1-Step-down Transformer, with center tap, for filament supply;
- 1 UX-210 or VT-2 (or other low-power Transmission Tube) with socket;
- 1 Grid Leak, 5,000-ohm;
- 1 Radiation Ammeter, 0-2½-ampere scale;
- 1 Milliammeter, 0-250 scale;
- 1 Transmitting Key;
- 25 feet Copper Ribbon, and miscellaneous.

This set requires very little description. It is built in two units, the one being the antenna coupling unit, and the other the oscillator proper. Both are mounted on 2-inch pillars to keep them above the baseboard; and the inductances of edge-wise-wound copper ribbon are mounted on the condensers with 2½-inch pillars.

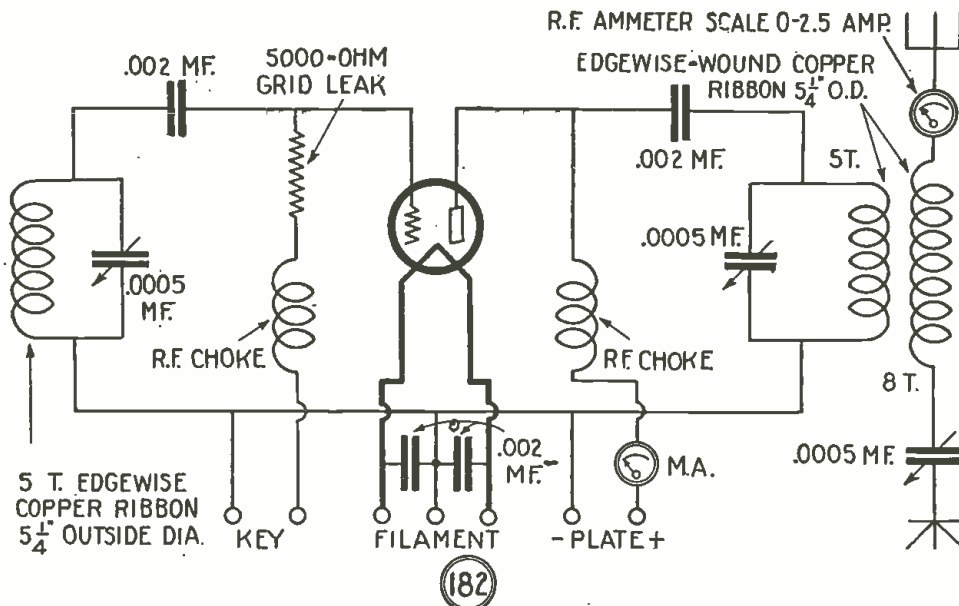

An exceedingly simple and efficient low-power short-wave transmitter, for continuous-wave transmission. At least 350 volts on the plate should be employed to obtain satisfactory results. A UX-210 or CX-310 tube is recommended; although the 50-watt type can be employed, providing a larger plate voltage can be obtained. A milliammeter of a larger scale would also be necessary, if the larger tube is used.

The oscillator unit is constructed by mounting, on a composition panel 10x24 inches, two of the variable condensers, ten inches apart; between them is placed the socket, with the plate and grid connections toward the front. The choke coils are mounted on tips, and arranged to plug into tip jacks in the base. The antenna unit is mounted on a base 5x12 inches.

Each inductance is supported by three pieces of insulating composition, 3/8-inch square, in which slots have been cut with a hack saw, 3/8-inch apart. The improvement to be secured by the use of glass spacers would be very small.

If no wavemeter is possessed by the constructor, he may readily take the antenna unit to some place where one is available; and with a galvanometer or neon tube to close the circuit, calibrate it so that it may be used to tune the set. The meter is then removed and the antenna and ground hooked on, to use the unit for its primary purpose.

The operation of the set is very simple. The grid and plate circuits are tuned until, with the key up, the milliammeter in the plate lead shows a very slight or no current; at which point the grid and plate

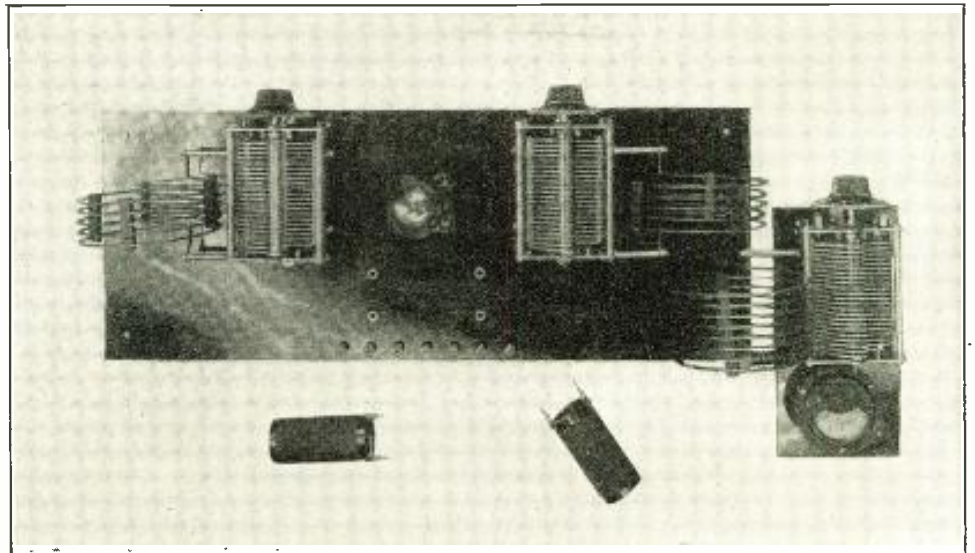

This illustration of the transmitter diagramed above shows the position of the various instruments, and the construction of the coil and condenser unit. This simplified construction permits access to any tuned circuit unit, and the removal of each when desired. The construction of the coils and their mounting can also be plainly seen.

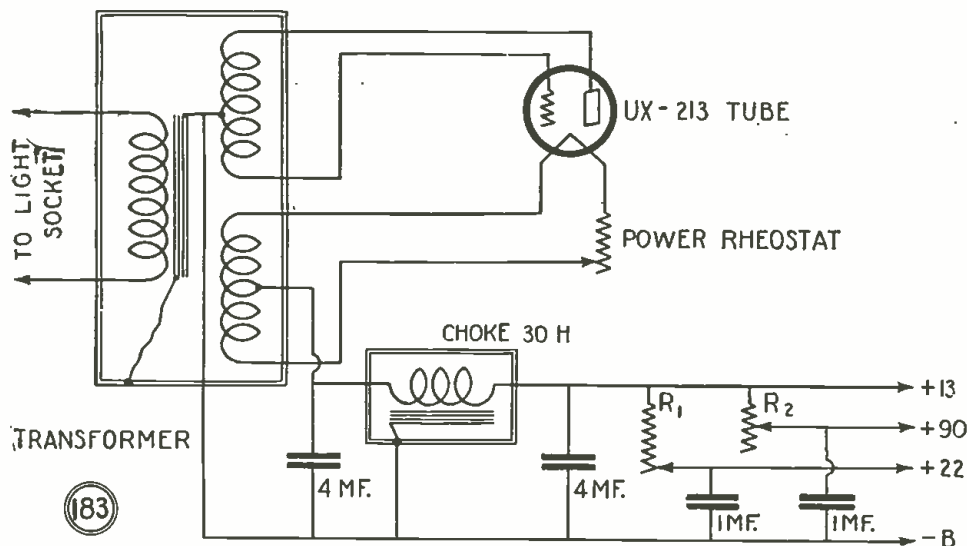

For the constructor who desires to make a simple and efficient "B" eliminator, which will satisfactorily produce enough current to operate a 10-tube set. Three "B-L" voltages are supplied, so that any type of receiver can satisfactorily be taken care of.

circuits are in resonance. Here depression of the key should result in a large plate-current reading. For 40 meters this should take place at about 23 on the dials of the grid and plate condensers; and for 80 meters at about 96 on both condensers.

The antenna is tuned in the usual manner to the point where maximum resonance is indicated by the radiation ammeter; but best results will probably be secured if it is then detuned slightly.

A SIMPLE AND EFFICIENT "B" ELIMINATOR

Circuit No. 183. There is no doubt but that the coming season will see an enormous increase in the demand for battery eliminators. To be in style, the experimenter might as well start building his eliminator now; so that by the time interest in radio reception and DX is at its height, the apparatus will be properly installed and adjusted for best results.

Data are not easily obtained on a "B" eliminator which is simple to construct, and whose parts may be readily obtained everywhere. However, this particular type is unusually simple; and the necessary apparatus should be readily obtainable at any good retail radio store. The constructor is assured of a remarkably

efficient "B" battery substitute, if he carefully follows instructions and builds the unit neatly and properly of good materials. The apparatus required comprises:

- 1 Transformer, step-up type (especially designed for such construction, with an additional secondary winding to supply filament current for the rectifying tube);
- 1 Choke Coil, 30-henry;
- 1 Power Rheostat;
- 1 UX-213 Tube and Socket;
- 4 By-pass Condensers, two 4- μ f., two 1- μ f.;
- 2 Variable Resistances; one 0-100,000-ohm (R1); one 0-50,000-ohm (R2).

The voltages for the R.F. and detector tubes of the receiver may easily be varied as desired by adjusting the resistances R1 and R2.

The voltage figures shown at each output are only approximate estimates; their value may be easily determined by simply connecting a voltmeter, 0-150 scale between "B—" and the post at which it is desired to determine the output voltage. R1 or R2 is varied until the desired regulation is reached.



Constructing a Ripple Meter

By EDWARD W. BERRY

THE writer has covered, previously, to some degree, the formation of ripples (see RADIO NEWS for August, 1924—"Ripples, Normal and Abnormal") and also the elimination of ripples (RADIO NEWS for October, 1925—"All about Filters"). In this present article he wishes to present the development of a meter to measure these ripples and to test the effectiveness of filters.

The "ripple component" is often referred to as some mysterious foreign element mixed in with the supply. If it were only some strange extra current, floating along the circuit by itself, it would probably be an easy matter to corner it, measure it, and eliminate it from the circuit. Unfortunately this so-called "ripple component," as its name in-

quire 20 milliamperes to read 110 volts, and the frequency of the supply to be 60 cycles. The reactance of the condenser would be approximately 662 ohms. The voltage drop across it would be $.020 \times 662$, or 13.24 volts.

This would be too great an error. It will be necessary either to increase the capacity or to use a voltmeter which consumes less current. The use of more condensers would be the most practical, say 10- $\mu f.$, capacity. The reactance will now be 265 ohms, and the drop 5.2 volts. This, with a correction table, is passable. Remember that, while the voltage, which in this case is all ripple, is 110 volts, the actual fluctuation is twice this amount; that is from -110 volts to +110 volts.

Now let us try this in a case similar to Fig. 2. Take a 50-volt D.C. generator and connect it in series with a 10-volt A.C. supply. We will now find that, when we apply our meter, the D.C. component will be blocked out by the condenser and the meter will show the 10-volt ripple. It should be noted that for half a cycle the ripple is opposing the D.C., and that the 10 volts shown by the voltmeter is one-half the actual fluctuation, as the voltage varies from 40 to 60.

COMPENSATING THE METER

The illustration shows a rather crude but effective ripple meter constructed by the writer. The entire apparatus is contained in a wooden box about 24x18x10 inches. The panel front is made of laminated wood, about 1/8-inch thick. The small meter panel is set back so that the meter is well protected, mechanically, by the box sides and the partition. The compartment in the upper right corner is used to carry headphones and test leads.

Fig. 3 is the wiring diagram of the meter. By referring to this and the picture, a clear idea of the construction and operation of the ripple meter may be obtained.

The meter is a standard A.C. 0-20 milliammeter of high resistance (1950 ohms). The addition of a 50-ohm resistance in series makes this meter read one half the voltage, for full-scale deflection: that is, the scale

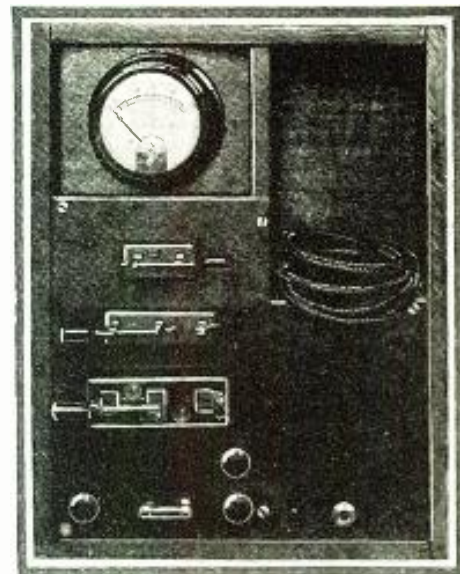

A front view of the completed Ripple Meter, showing the essential control switches and, above, the milliammeter.

0-20 may be read 0-40 volts. The proper resistance to use with an instrument may be easily determined and made in the following manner.

First we must determine whether the milliammeter to be used is of high or low resistance. An easy way to do this is to take a voltmeter with a range of 0-30 volts, connect it across the terminals of a battery within its

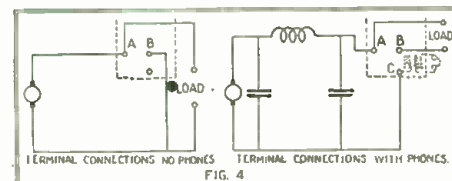

External connections to the Ripple Meter for testing.

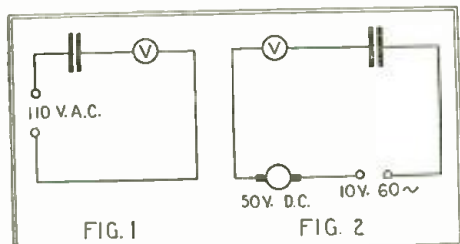

Due to the reactance of the condensers and the current consumption of the voltmeters in these two circuits there is an appreciable voltage drop which must be taken into consideration.

indicates, is a component part of the supply and consequently presents some difficulties when one attempts to measure it.

Let us suppose we have an A.C. supply of 110 volts, as in Fig. 1, and connect in series with it a voltmeter and a large condenser, as indicated. If the condenser is large, say 2- $\mu f.$, and the current drawn by the voltmeter is small, a few milliamperes, the voltmeter will indicate the effective voltage, 110 volts. The average voltmeter will not do here, on account of the current which it draws. The voltage drop in the circuit should be for the most part across the voltmeter, not the condenser. As an example of this, let us assume the condenser is 4- $\mu f.$, the voltmeter to re-

range and note the reading. Now connect the milliammeter in series with it and note the reading of the voltmeter when the two are placed across the same battery. If the voltmeter now reads much lower, about half of what it did across the battery without the milliammeter, the latter is of high resistance.

If the reading of the voltmeter with the milliammeter in series is about the same as when used alone, the milliammeter is of low-resistance type, and care must be taken when trying to use it as a voltmeter. If it is found that this meter is high-resistance, then it may safely be put across the battery, a single cell at first. Try various cell combinations until a good deflection is obtained, about a quarter to half scale. Let us say that it reads 10. This means of course, that 10 milliamperes are passing thru the meter. The only thing limiting the flow of the current is the resistance of

(Continued on page 268)

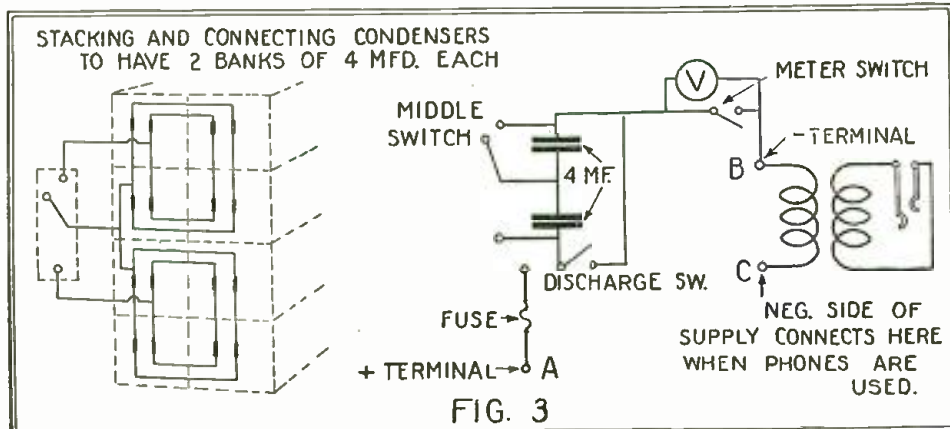

The complete wiring diagram of the Ripple Meter. At the left is shown a bank of eight fixed condensers, connected to provide two 4- $\mu f.$ units, or, in series, one 2- $\mu f.$ capacity.



APPROVED
RADIO NEWS
LABORATORIES
1922

RADIO NEWS LABORATORIES



RADIO manufacturers are invited to send to RADIO NEWS LABORATORIES, samples of their products for test. It does not matter whether or not they advertise in RADIO NEWS, the RADIO NEWS LABORATORIES being an independent organization, with the improvement of radio apparatus as its aim. If, after being tested, the instruments submitted prove to be built according to modern radio engineering practice, they will each be awarded a certificate of merit, and a "write-up" such as those given below will appear in this department of RADIO NEWS. If the apparatus does not pass the Laboratory tests, it will be returned to the manufacturer with suggestions for improvements. No "write-ups" sent by manufacturers are published on these pages, and only apparatus which has been tested by the Laboratories and found to be of good mechanical and electrical construction is described. Inasmuch as the service of the RADIO NEWS LABORATORIES is free to all manufacturers whether they are advertisers or not, it is necessary that all goods to be tested be forwarded prepaid, otherwise they cannot be accepted by the Laboratories. Apparatus ready for the market or already on the market will be tested for manufacturers, as heretofore, free of charge. Apparatus in process of development will be tested at a charge of \$2.00 per hour required to do the work. Address all communications and all parcels to RADIO NEWS LABORATORIES, 53 Park Place, New York City.

VACUUM-TUBE SOCKET

The vacuum-tube socket shown was submitted to the RADIO NEWS LABORATORIES for test, by AmSCO Products, Inc., 416 Broome St., New York City, N. Y. This vacuum tube socket, which is of the UX type, has a series of springs mounted in the center, so that the main portion of the socket is virtually floating. This arrangement effectively absorbs mechanical vibrations.



AWARDED THE RADIO NEWS LABORATORIES CERTIFICATE OF MERIT NO. 1488.

CONDENSER BLOCK

The condenser block shown was submitted to the RADIO NEWS LABORATORIES for test, by the Tobe-Deutschmann Company, Cornhill, Boston, Mass. It was designed for use in "B" battery eliminator circuits. There are three separate banks, the first and second being 2- μ f. each and the third 8- μ f.



AWARDED THE RADIO NEWS LABORATORIES CERTIFICATE OF MERIT NO. 1467.

CONDENSER BLOCK

The condenser block shown was submitted to the RADIO NEWS LABORATORIES for test, by the Tobe-Deutschmann Company, Cornhill, Boston, Mass. This bank of condensers, included in a single case, is for use in "B" battery eliminator circuits. All of the capacities required for the filter are included.



AWARDED THE RADIO NEWS LABORATORIES CERTIFICATE OF MERIT NO. 1468.

VACUUM-TUBE SOCKET

The vacuum-tube socket shown was submitted to the RADIO NEWS LABORATORIES for test, by the Chicago Telephone Supply Co., Elkhart, Ind. This socket is of the UX type, is made of excellent material and has strong springs which ensure perfect contact with the tube prongs.



AWARDED THE RADIO NEWS LABORATORIES CERTIFICATE OF MERIT NO. 1476.

LIGHT SWITCH

The light switch shown was submitted to the RADIO NEWS LABORATORIES for test, by the Bruno Radio Corp., New York City. This is a combination filament switch and pilot lamp, and may be mounted directly in front of the panel. The pilot lamp is lighted at all times during the operation of the set.



AWARDED THE RADIO NEWS LABORATORIES CERTIFICATE OF MERIT NO. 1454.

TRIPLE CONDENSER

The triple condenser shown was submitted to the RADIO NEWS LABORATORIES for test, by the Alden Mfg. Co., 54 Willow St., Springfield, Mass.



This triple condenser is particularly adaptable to tuned-radio-frequency circuits. Each condenser can be adjusted separately, or all can be adjusted simultaneously, by the movement of the three knurled dials. AWARDED THE RADIO NEWS LABORATORIES CERTIFICATE OF MERIT NO. 1483.

AUTOMATIC FILAMENT CONTROL

The "Elkay Equalizer" shown was submitted to the RADIO NEWS LABORATORIES for test, by the Langbein-Kaufman Radio Co., 511 Chapel St., New Haven, Conn. It was tested in the filament circuits of various

tubes and found to conform to the claims of the manufacturer.



AWARDED THE RADIO NEWS LABORATORIES CERTIFICATE OF MERIT NO. 1393.

TUBE

The "Sky Sweeper" tube shown was submitted to the RADIO NEWS LABORATORIES for test, by Charles R. Ablett Company, 22 Reade St., New York City. It successfully passed the tests, having conformed to the requirements for present-day tubes.



AWARDED THE RADIO NEWS LABORATORIES CERTIFICATE OF MERIT NO. 1397.

COIL WIRE

The coil wire shown was submitted to the RADIO NEWS LABORATORIES for test, by the Belden Manufacturing Company, Chicago, Ill.



This coil wire comes in various gauges, and in both cotton- and silk-covered insulation. AWARDED THE RADIO NEWS LABORATORIES CERTIFICATE OF MERIT NO. 1438.

LOUD SPEAKER

The loud speaker shown was submitted to the RADIO NEWS LABORATORIES for test, by the American Wood Turning Co., 514 W. Van



Buren St., Chicago, Ill. It is a departure from the usual horn construction.

The tonal qualities were found to be excellent.

AWARDED THE RADIO NEWS LABORATORIES CERTIFICATE OF MERIT NO. 1343.

RHEOSTAT

The Rheostat shown was submitted to the RADIO NEWS LABORATORIES for test, by the Chicago Telephone Supply Co., Elkhart, Ind.



It is of the heavy-duty type, having a resistance of 2 ohms, and is adaptable to the control of a number of tubes or a single power-amplifier tube. It is rugged in construction.

AWARDED THE RADIO NEWS LABORATORIES CERTIFICATE OF MERIT NO. 1478.

VACUUM TUBE ADAPTOR

This vacuum tube adaptor shown was submitted to the RADIO NEWS LABORATORIES for test, by the Chicago Telephone Supply Co., Elkhart, Ind.



This adaptor makes it possible for a UX or UV type of dry-cell tube to be inserted in a Standard UV socket. It is made from a very good grade of insulating material.

AWARDED THE RADIO NEWS LABORATORIES CERTIFICATE OF MERIT NO. 1477.

VACUUM TUBE

The vacuum tube shown was submitted to the RADIO NEWS LABORATORIES for test, by the Sonatron Tube Company, 220 South State St., Chicago, Ill.



These tubes were tested under all conditions, and were found good both as detectors and amplifiers.

AWARDED THE RADIO NEWS LABORATORIES CERTIFICATE OF MERIT NO. 1403.

MILLIAMMETER

The D.C. milliammeter shown was submitted to the RADIO NEWS LABORATORIES for test, by the Hoyt Electrical Instrument Works, Penacook, N. H. It is an exceptionally fine instrument for test work, with a scale range from zero to 100 milliamperes. It is adaptable to panel mounting.



AWARDED THE RADIO NEWS LABORATORIES CERTIFICATE OF MERIT NO. 1440.

COMBINATION METER

The combination meter shown was submitted to the RADIO NEWS LABORATORIES for test, by the Hoyt Electrical Instrument Works, Penacook, N. H. This meter is of the panel-mounting type, and is to be used in connection with the Multi-Switch. It



has scale ranges from zero to 7.5 volts, zero to 150 volts and zero to 7.5 milliamperes.

AWARDED THE RADIO NEWS LABORATORIES CERTIFICATE OF MERIT NO. 1489.

MULTI-SWITCH

This multi-switch was submitted to the RADIO NEWS LABORATORIES for test, by the Hoyt Electrical Instrument Works, Penacook, N. H. When used in conjunction with the com-



ination meter it allows the reading of the voltage of the "A" and "B" batteries, as well as the plate-current flow in milliamperes. It can be mounted directly on the panel of the set.

AWARDED THE RADIO NEWS LABORATORIES CERTIFICATE OF MERIT NO. 1491.

PLUG-IN VOLTMETER

The plug-in voltmeter shown was submitted to the RADIO NEWS LABORATORIES for test, by the Hoyt Electrical Instrument Works, Penacook, N. H. Its purpose is giving filament



voltage readings. The scale range is zero to 6 volts, with an indication at 3 volts for dry-cell tubes. It employs pin-jacks plugging into the panel of the receiving set.

AWARDED THE RADIO NEWS LABORATORIES CERTIFICATE OF MERIT NO. 1440.

VOLTMETER

The voltmeter shown was submitted to the RADIO NEWS LABORATORIES for test, by the Hoyt Electrical Instrument Works, Penacook, N. H. It is of the panel-mounting type



and has a scale reading from zero to 150 volts, making it particularly use-



ful for testing "B" batteries. It has an external shunt resistance.

AWARDED THE RADIO NEWS LABORATORIES CERTIFICATE OF MERIT NO. 1440.

PANEL VOLTMETER

This panel voltmeter was submitted to the RADIO NEWS LABORA-



TORIES for test, by the Hoyt Electrical Instrument Works, Penacook, N. H. The scale reading is zero to 6 volts, with an indication at three volts for dry cell tubes.

AWARDED THE RADIO NEWS LABORATORIES CERTIFICATE OF MERIT NO. 1440.

TABLE-MOUNTING VOLT-METER

The voltmeter shown was sub-



mitted to the RADIO NEWS LABORATORIES for test, by the Hoyt Electrical Instrument Works, Penacook, N. H. The scale range is zero to 6 volts, with an indication at 3 volts. Its main purpose is testing "A" battery and filament voltages.

AWARDED THE RADIO NEWS LABORATORIES CERTIFICATE OF MERIT NO. 1440.

MILLIAMMETER

The D.C. milliammeter shown was submitted to the RADIO NEWS LABORA-

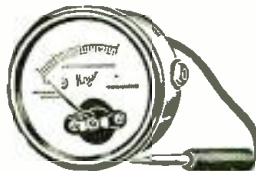

TORIES for test, by the Hoyt Electrical Instrument Works, Penacook, N. H., and was found to be of excellent construction. It has a scale reading from zero to 15 milliamperes.

AWARDED THE RADIO NEWS LABORATORIES CERTIFICATE OF MERIT NO. 1490.

COMBINATION VOLTMETER

The meter shown was submitted to the RADIO NEWS LABORATORIES for test, by the Hoyt Electrical Instru-

ment Works, Penacook, N. H. This type combination meter gives a reading from zero to 150 volts, and zero to 7.5 volts, thus making it particularly adaptable for test work in connection with receiving circuits.

AWARDED THE RADIO NEWS LABORATORIES CERTIFICATE OF MERIT NO. 1440.

R. F. TRANSFORMER

The transformer shown was submitted to the RADIO NEWS LABORA-



TORIES for test, by the General Manufacturing Company, 6637 Cottage Grove Ave., Chicago, Ill. It employs coils of the basket-weave type; and test proved it to be very efficient.

AWARDED THE RADIO NEWS LABORATORIES CERTIFICATE OF MERIT NO. 1461.

A.F. TRANSFORMER

This audio-frequency transformer was submitted to the RADIO NEWS LABORATORIES for test, by the General Radio Co., Ltd., Radio House, Regent St., London W., England. It has a large iron core and a high-impedance primary winding, making it suitable for the amplification of low audio frequencies.



AWARDED THE RADIO NEWS LABORATORIES CERTIFICATE OF MERIT NO. 1432.

VACUUM TUBE

The vacuum tube shown was submitted to the RADIO NEWS LABORA-



TORIES for test, by the C. E. Mfg. Co., 702 Eddy St., Providence, R. I. It was found to have exceptionally good characteristics. It can be used as a detector or an amplifier.

AWARDED THE RADIO NEWS LABORATORIES CERTIFICATE OF MERIT NO. 1455.

VARIABLE CONDENSER

The condenser shown was submitted to the RADIO NEWS LABORA-



TORIES for test, by the Benjamin Electric Manufacturing Company, 847 West Jackson Boulevard, Chicago, Ill. This variable condenser is of the straight-line-frequency type, and has been found to have a very good curve. The insulating material has been reduced to the minimum.

AWARDED THE RADIO NEWS

LABORATORIES CERTIFICATE OF MERIT NO. 1437.

VARIABLE CONDENSER

The condenser shown was submitted to the RADIO NEWS LABORATORIES



for test, by the General Radio Company, Radio House, Regent Street, London, W. England. This variable condenser is of the square-law type, and is contained in the dial itself. The whole unit is mounted on the front of the panel. It is of excellent construction.

AWARDED THE RADIO NEWS LABORATORIES CERTIFICATE OF MERIT NO. 1433.

AUDIO TRANSFORMER

The audio transformer shown was submitted to the RADIO NEWS LABORA-



TORIES for test, by Ferranti, Ltd., Hollinwood, Lancashire, England. This audio transformer was found to be an excellent amplifier of both low and high frequencies. It has a large iron core and a high-impedance primary winding.

AWARDED THE RADIO NEWS LABORATORIES CERTIFICATE OF MERIT NO. 1486.

CONE LOUD SPEAKER

The cone loud speaker shown was submitted to the RADIO NEWS LABO-



RATORIES for test, by The Rola Company, Oakland, Calif. It employs a small floating cone, the periphery of which is attached to a large mahogany ring support, which functions both as a baffle and sounding board.

AWARDED THE RADIO NEWS LABORATORIES CERTIFICATE OF MERIT NO. 1470.

VARIABLE CONDENSER

The variable condenser shown was submitted to the RADIO NEWS LABORATORIES for test, by the Ormond Engineering Co., Lt., 205 Pentonville Road, London, England. It is of the straight-line-frequency type. The minimum capacity is low;



the maximum capacity is .00035- μ f. It is of excellent construction.

AWARDED THE RADIO NEWS LABORATORIES CERTIFICATE OF MERIT NO. 1496.



Conducted by Joseph Bernsley

THIS Department is conducted for the benefit of our Radio Experimenters. We shall be glad to answer here questions for the benefit of all, but we can publish only such matter as is of sufficient interest to all.

1. This Department cannot answer more than three questions for each correspondent. Please make these questions brief.
2. Only one side of the sheet should be written upon; all matter should be typewritten or else written in ink. No attention paid to penciled matter.
3. Sketches, diagrams, etc., must be on separate sheets. This Department does not answer questions by mail free of charge.
4. Our Editors will be glad to answer any letter, at the rate of 25c. for each question. If, however, questions entail considerable research work, intricate calculations, patent research, etc., a special charge will be made. Before we answer such questions, correspondents will be informed as to the price charge.

Mr. Bernsley answers radio questions from WRNY every Thursday at 8:15 P. M.

The I Want to Know Department can not undertake to supply picture diagrams of circuits; the schematic diagrams, which are standard in their use of symbols, are made as plain as possible and full information is given with them. When a picture diagram of a given circuit is available elsewhere, we will supply this information on request.

GHIRARD VIII OSCILLATOR-COUPLER

(Q.-2184) Mr. S. R. Kehrer, Woodbury, N. J., asks as follows:

Q. 1. Can you furnish me with complete constructional data of the oscillator coupler employed in the Ghirard VIII Super-Heterodyne receiver, described in the April, 1926, issue of RADIO NEWS? I was successful in obtaining the Sanson Electric Company's 60-kc. intermediate-frequency transformers, which are employed in this set, but was not very successful in constructing an efficient oscillator coupler to operate in conjunction with the above mentioned.

A. 1. This department has received numerous questions for the design data on this particular instrument; and we therefore print the complete details in these columns. (See Fig. Q.-2184).

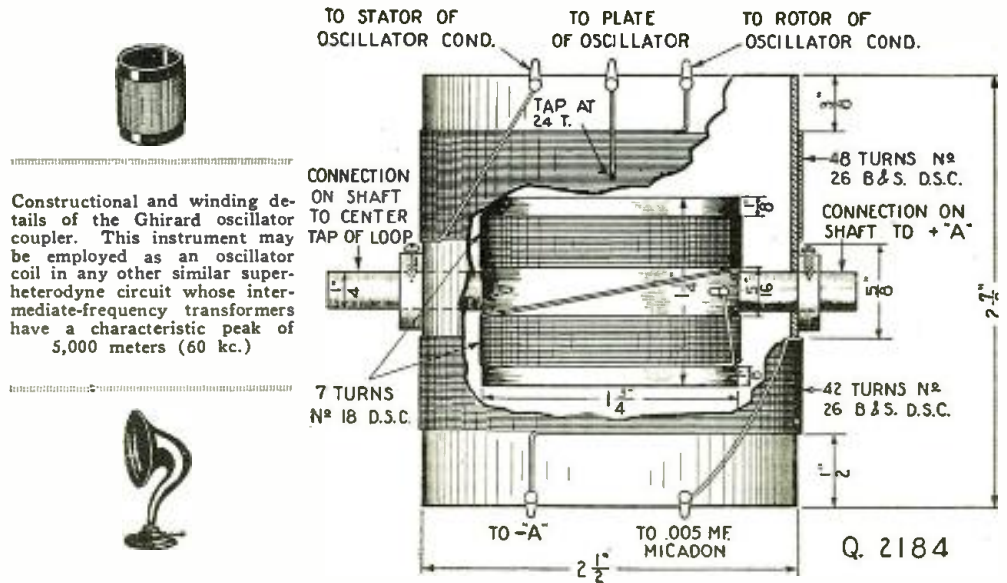

Constructional and winding details of the Ghirard oscillator coupler. This instrument may be employed as an oscillator coil in any other similar super-heterodyne circuit whose intermediate-frequency transformers have a characteristic peak of 5,000 meters (60 kc.)

RADIOLA 28 RECEIVER

(Q.-2185) Mr. L. J. Kanter, Cleveland, Ohio, asks as follows:

Q. 1. Can you furnish me with the schematic wiring diagram of the Radiola 28 receiver? Accidentally a few connections have become loose and I would like to obtain a wiring diagram, so that I can trace the connections and find the proper places for the loose connections.

A. 1. The schematic wiring diagram of the Radiola 28 receiver is shown in Fig. Q.-2185. Those who may desire to construct a Super-Heterodyne receiver employing this circuit and peculiar characteristics, will be interested to know that any 60-kc. type of intermediate-frequency transformer can be satisfactorily employed. The UV-1714 transformer (5,000 meters) will serve excellently in conjunction with the oscillator coupler illustrated in answer to Q.-2184. The loop circuit is tuned by a .0005- μ f. variable condenser, preferably of the straight-line-frequency type. The oscillator condenser is of the same capacity. A

UX-120 power tube is employed in the last stage, for which increased "B" and "C" voltages must be used. The small neutralizing condenser, indicated as NC on the diagram, is an ordinary small midjet balancing condenser, consisting of 5 or 7 small plates (total, including stator and rotor plates). The original model was specially designed to operate with dry-cell tubes.

BEST'S 5-TUBE SUPER-HETERODYNE SET

(Q.-2186) Mr. H. T. Borden, Portland, Maine, asks as follows:

Q. 1. I am advised that G. M. Best has designed a new super-heterodyne receiver, a 5-tube affair. Have you any constructional data on this receiver? Would appreciate any schematic diagram

and any additional information.

A. 1. The Best 5-tube super-heterodyne receiver was originally featured in the April, 1926, issue of "Radio" magazine. The following are parts of the description of this receiver from the article, written by G. M. Best, which appeared in the publication mentioned.

"The salient features of the circuit are selectivity, superb quality of output, excellent volume with cone loud speaker, by the use of a power tube, economy in battery consumption, as only five tubes are required, and ease of assembly by the use of both sides of the shelf for mounting the apparatus.

"The principal difference between this super-heterodyne and others previously described is in the use of two carborundum crystal detectors for the frequency changer and the detector, commonly called the first and second detectors. It has long been known that crystals could be used

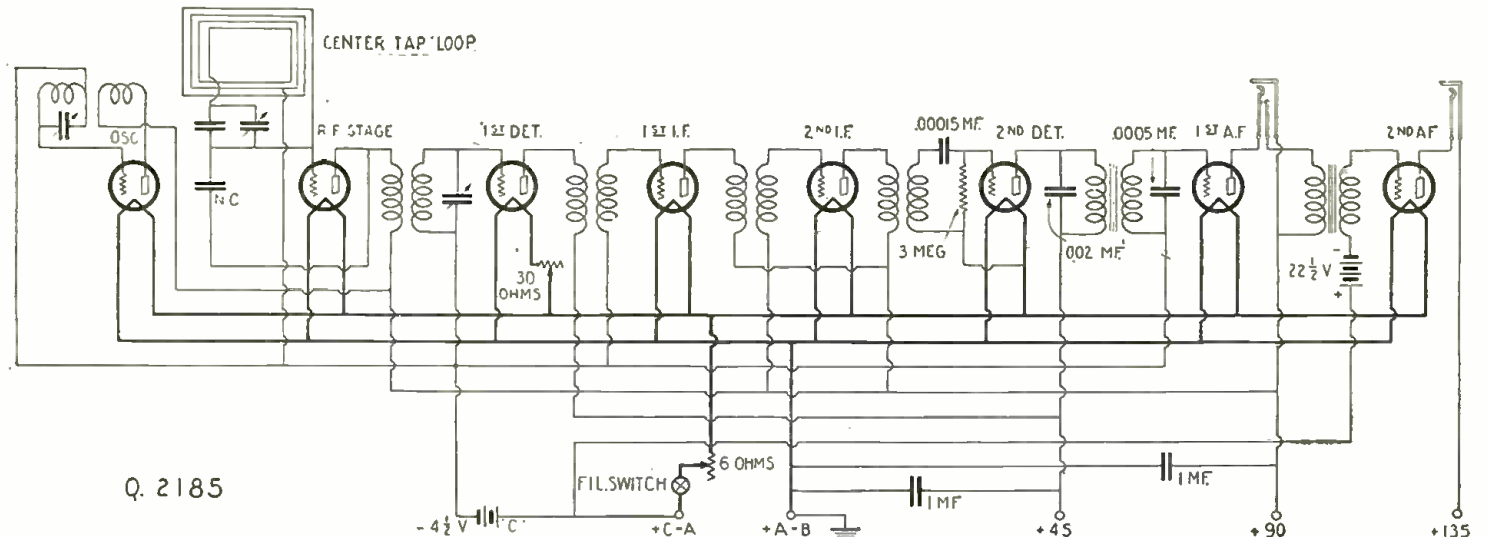

The circuit diagram of the Radiola 28 receiver (super-heterodyne type). Super-heterodyne parts designed to operate with an intermediate-frequency amplifier of the 5,000-meter type (60 kc.) may be employed satisfactorily with this particular circuit.

in these positions in a super-heterodyne; but the objections were that the crystal was not easily adjusted, had a low internal resistance which destroyed selectivity, and was not sufficiently sensitive.

"The new carborundum detector, however, has none of these disadvantages, as it has a permanent adjustment under pressure which prevents instability; has a high internal resistance, so that the detector will have little or no damping effect on the tuned transformer or antenna tuner; and is remarkably sensitive. The carborundum detector, in order to produce maximum results, requires a small battery to control the detector resistance and sensitivity. A new unit is now available which consists of a small flash-light dry cell, a potentiometer, by-pass condenser and carborundum detector, arranged for convenient panel mounting and adjustment.

"Working with two of these detectors as a basis, a five-tube super-heterodyne was developed, which had the sensitivity of a seven-tube circuit, with greater selectivity and less battery drain than conventional five-tube tuned R.F. receivers. (By reference to the schematic wiring diagram in Fig. Q-2186, the general arrangement of the circuit can be understood.)

Avoiding Radiation

"While the set can be operated with a loop antenna, many readers object to the loop for various reasons, and prefer to use an outdoor antenna. Realizing that the indiscriminate use of the set with the antenna without due regard to the radiation of the receiver when improperly operated, would cause a great amount of harm to neighboring receivers, an antenna system was selected, which, when properly adjusted, will cause a minimum amount of radiation of the oscillator output. The antenna circuit consists of a series air condenser, loading coil, and coupling coil. If the loading coil is the proper size, the antenna system will tune through the broadcast band without difficulty. The coupling coil is arranged so that very loose coupling can be obtained, and a center tapped secondary is used to obtain greater selectivity.

"The antenna condenser is mounted on the left end of the panel, and the secondary tuning condenser, which is similar in size to the antenna condenser, is in the center of the panel.

"The frequency-changer circuit is connected to the secondary of the antenna tuner, and consists of a pick-up coil placed in the field of the oscillator, a carborundum detector unit, and the primary of the first intermediate-frequency transformer. The oscillator is of the conventional pattern, and is tuned by another variable condenser of .0005- μ f. capacity in series with a protective .006- μ f. fixed condenser; the latter preventing tube burn-outs in case the air condenser develops a short circuit.

The intermediate-frequency amplifier consists of two stages, with storage-battery tubes.

Parts necessary for the construction of this receiver are as follows:

- 3 Variable Condensers, .0005- μ f.;
- 1 Antenna Load Coil;
- 1 Antenna Coupler;
- 1 Oscillator Coupler;
- 2 Intermediate-Frequency Transformers;
- 1 Filter Transformer;

- 2 Audio-Frequency Transformers;
- 2 Carborundum Crystal-Detector units;
- 4 Automatic Filament Resistances, $\frac{1}{4}$ -amp. size;
- 1 Automatic Filament Resistance, $\frac{1}{2}$ -amp. size;
- 1 Filament Switch;
- 2 Fixed Condensers, 1- μ f.;
- 1 Mica Condenser, .006- μ f.;
- 1 Mica Condenser, .002- μ f.;
- 1 Filter Tuning Condenser;
- 1 Grid Leak, $\frac{1}{2}$ -megohm with mounting;
- 1 Tube-Protective Resistance Unit—500-ohm;
- 2 $\frac{1}{2}$ -volt "C" Batteries;
- 5 X-type Sockets;
- 1 Single-circuit Jack;
- 1 Variable Resistor, 50,000-ohm;
- 1 Binding Post Strip—7 posts;
- 1 Panel, 10x20x3/16 in.;
- 1 Bakelite or Formica Shelf, 5x18 $\frac{3}{4}$ x $\frac{1}{4}$ in.;
- 2 Brackets for Shelf;
- Insulated and bare wire, 3 doz. $\frac{1}{2}$ -in. 6/32 r.h. brass machine screws, and four 1-in. flat-head brass 6/32 machine screws for fastening brackets to panel.

Coil Data

"The antenna coil may be made by winding 125 turns of No. 26 silk-covered wire on a 2 $\frac{3}{4}$ -in. bakelite tube 3 in. long. The antenna tuning coil comprises a stator and rotor. The stator coil consists of 70 turns of No. 26 S.C. wire, wound on a 2 $\frac{1}{2}$ -in. tube, 2 $\frac{1}{2}$ in. long; a tap is taken off at the 35th turn, for connection to the ground circuit. The rotor, or antenna coupling coil, is wound on a 1 $\frac{1}{2}$ -in. tube, and consists of 10 turns of No. 26 S.C. wire. If the set is not sufficiently selective, it may be necessary to reduce the number of turns of wire on the rotor.

"The oscillator-coupler is identical in dimensions with the antenna coupling coil, except that when using the "A" tube as an oscillator, 5 turns in the pick-up coil will be ample; and it may be possible to reduce the turns to 3 or 4, where sufficient energy is obtained from the oscillator. In this connection, the "A" tube delivers more energy as an oscillator than a type 99 tube under similar conditions; and it is a good idea to reduce the oscillator output by placing an additional filament resistance cartridge in series with the filament of the oscillator, which will serve to reduce the filament current of the tube. A variable filament rheostat at this point would give greater flexibility, but it has been found that two 6-volt automatic filament control units in series will reduce the oscillator output to just the right amount. If the type 99 tube is used, the normal filament current of 60 milliamperes should be employed."

SOLENOID COIL DATA

(Q.-2187) Mr. J. B. Watson, Springfield, Mass., asks as follows:

Q. 1. Have you any data or information available relative to various size coils of the solenoid type (number of turns, diameter, etc.) and the wave-length range that they are capable of covering? Any information or chart data that you could furnish or refer me to would be entirely satisfactory.

A. 1. The most complete compilation of coil sizes and their wave-length ranges including number of turns, size of wire, etc., that we have available is reproduced on the next page.

These tables will enable the amateur experimenter to wind cylindrical coil inductances on any of the sizes of tubes in common use. It should be noted that the number of turns given, in each case, will bring in the wave-length without a condenser. That is, the inductance will act as though it were a coil tapped in tens and units, in which every single turn can be varied. With a condenser added in parallel, the wave-length will be greater, but as such a coil is tapped in fives or in tens the taps will compensate. Enamelled wire has been specified, but only for convenience; and if wires with other coverings are used the inductance of the coil will be slightly less but not sufficiently to make any material difference. The number of turns per inch, however, will vary with the kind of insulation used.

Note, however, that the SWG gauge is used in the following chart. The difference between this and the B. & S. gauge is very slight and the sizes can be said to be practically similar (i.e., 22 SWG gauge practically the same as 22 B. & S. gauge). However, for those who are somewhat critical and more exacting we are reprinting a "conversion table," which appeared in the Correspondence columns of the February, 1926, issue of RADIO NEWS.

The following tables give diameters in millimeters corresponding to the Brown & Sharpe gauge, standard in America, and the S.W.G., standard in Great Britain.

Numbers	Brown & Sharpe	S.W.G.
000.000	11.785
00.000	10.972
0.000	11.683	10.16
000	10.404	9.448
00	9.266	8.839
0	8.251	8.229
1	7.348	7.62
2	6.544	7.01
3	5.827	6.401
4	5.19	5.893
5	4.621	5.385
6	4.115	4.877
7	3.665	4.47
8	3.263	4.064
9	2.906	3.657
10	2.588	3.251
11	2.305	2.947
12	2.052	2.641
13	1.828	2.337
14	1.628	2.032
15	1.449	1.829
16	1.291	1.626
17	1.15	1.422
18	1.024	1.219
19	.911 6	1.016
20	.811 8	.914 4
21	.722 9	.812 4
22	.643 8	.711 2
23	.573 3	.609 6
24	.510 5	.558 8
25	.454 6	.508
26	.404 9	.457 2
27	.360 5	.416 6
28	.321 1	.375 9
29	.285 9	.345 4
30	.254 5	.315
31	.226 7	.294 6
32	.201 9	.274 3
33	.179 8	.254
34	.160 1	.233 7
35	.142 6	.213 4
36	.127	.193

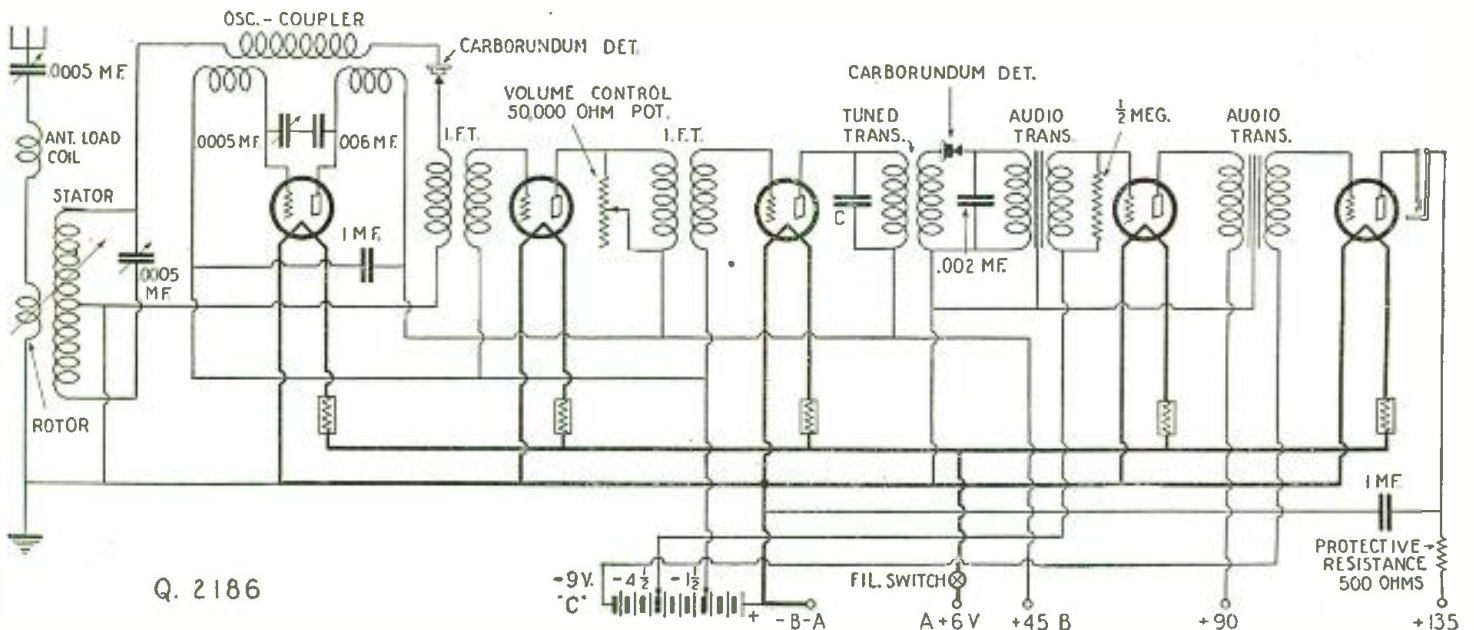

Best's 5-tube super. An innovation in supers, in that three tubes are eliminated by means of two crystal detectors. Although the sensitivity of the original receiver decreases somewhat, the set is unusually efficient and will satisfy particular constructors, especially as regards DX, volume, and clarity.

MAXIMUM WAVE-LENGTH OF COIL IN METERS. Table with columns: Size, Length, Diameter of Form, Inches (2, 2 1/2, 3, 3 1/2, 4, 4 1/2, 5, 5 1/2, 6), Turns, inches.

MAXIMUM WAVE-LENGTH OF COIL IN METERS. Table with columns: Size, Length, Diameter of Form, Inches (2, 2 1/2, 3, 3 1/2, 4, 4 1/2, 5, 5 1/2, 6), Turns, inches.

Correspondence from Readers

"UNDERGROUND AERIAL" RECEPTION

Editor RADIO NEWS: Mr. S. R. Winters' article in your June issue on "Radio Reception by Ground Alone," provoked me to carry out an experiment I have long had in mind.

a half dozen others, but faintly. Several of the above boomed in with loud speaker volume. What impressed me particularly was the fact that static was almost as troublesome as one encounters with an overhead aerial.

tests with wires in deep wells and, perhaps, attain worthwhile results. My summer camp is on top of the Cumberland plateau more than 2,000 feet above sea level.

L. L. Rice, Camp Nakawana, Maryland, Tenn.

(We referred the above to Dr. James Harris Rogers, of Underground Radio fame, and he says as follows:

"Your letter enclosing Mr. L. L. Rice's account of his underground test received, and I herewith comply with your request that I submit answers to his questions:

- 1st. I have never found any form of antenna that would eliminate STATIC. 2nd. Underground antennae are the most effective in reducing such interferences. 3rd. They are most efficient when placed in wet or moist earth. The deeper they are buried, the greater the signal strength, with corresponding reduction in strays or static. 4th. The short lead mentioned is somewhat detrimental, but the receiver and lead-in should be shielded. 5th. The location on mountains two thousand feet high, is anything but ideal. Much better results will be attained if located in wet earth at base of the mountain."

Could the static "pick-up" be very materially lessened by some sort of shielding of the receiver? I made no attempt to prove this. Further, it appeared that static was worse when I was listening to stations of low-wave length: for as I brought in stations higher up on the dial the noises decreased somewhat.

It may be that this experiment is of no practical worth to radio "bugs" and experts. Still I send it in the hope that it may provoke some other fellow to carry out real

CLEAR at a whisper....

CLEAR at the volume of a brass band....

REAL!

TURN it low—use the great power as a reserve to get the climax of a song without a crash. Turn it higher—let the dance music sound out clearly above the talk and the shuffling of feet. Or use it in a great hall—and get the actual volume of a great orchestra. Every instrument is real! With RCA Loudspeaker 104—get *natural* tone and *natural* volume.

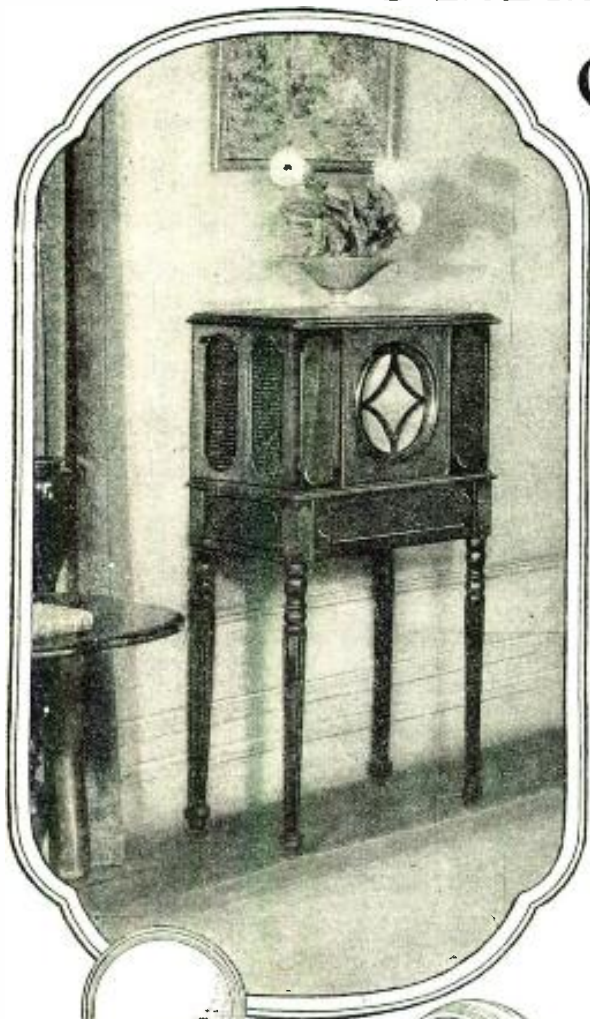

RCA Loudspeaker 102 adds a *power unit* to the Model 100. Plugged in on the house current, it has power to deliver almost any volume of tone—clear and undistorted. (For use on 50 to 60 cycle, 110 volt A. C. lighting circuit.) \$140



RCA Loudspeaker 100 gives clear, mellow, undistorted tone up to any volume your set can give it. It is really the only loudspeaker to buy when you use the *power tubes*. \$35

RCA Loudspeaker 104 is not only a power loudspeaker, but eliminates the "B" batteries of most sets. With RCA Radiola 25 or 28, it can be adapted to eliminate all batteries. It operates on the 50 to 60 cycle, 110 volt A. C. lighting circuit \$275



RCA Loudspeaker

MADE BY THE MAKERS OF THE RADIOLA



Permanent ACCURACY!

Metal long has been recognized as the best of electrical conductors. Because of metal, Lynch Metallized Resistors give *conductive, non-arcing resistance that does not break down nor change in resistance value in the acid test of time.*



Steel sky-scrapers withstand the ravages of time where crumbling cottages once stood. Lynch Resistors are impervious to moisture, do not change in resistance value and prove themselves in the exacting tests of time and service. The concentrated metallized deposit one-thousandth of an inch thick upon a core of glass is sealed forever within the tube.

Arthur H. Lynch

PRICES:—

.25 to 10 Megohms	.50	Single Mounting	.35
above .01 to .24 "	.75	Double	.50
.001 to .01 "	\$1.00		

This better-built product—the result of years of research and experiment—has won the endorsement of leading engineers, experimenters and test laboratories because it is warranted absolutely noiseless, permanently accurate, dependable!

If your dealer cannot supply you, we will ship by mail, post-paid, same day order is received—and Lynch products are sold on a money-back guarantee.

Dealers—Write us!

ARTHUR H. LYNCH, Inc.
Manufacturers of Radio Devices
Fisk Bldg., Broadway & 57th Street
New York, N.Y.

LYNCH METALLIZED FIXED RESISTOR

A New Idea in Set Construction

(Continued from page 235)

capacity shield and a common wiring system, is brought out in this article for the first time. It is hoped that our readers will gain an incentive to further experiment along these lines.

(Editor's Note—This receiver was made in the RADIO NEWS Laboratories and was placed under a severe test with other four- and five-tube sets. It has certainly proved its worth; and we are pleased to give our readers some food for thought for the future.)

What Price Salesmanship?

(Continued from page 209)

a lot more nerve (of a different brand) to sell radio goods in the manner in which that Connecticut dealer did.

That is the kind of salesmanship that injures the radio trade as a whole. One dealer may think he is getting away with murder—and he most likely is, for that matter—but the fellow whom he gyps is going to do an awful lot of yowling, when some friend tells him that he has been stung. There was my friend Mr. Johnson, who wanted to go to town that very evening and take the hide off his dealer, when he saw what a relatively simple matter it was to make his set work. Does anyone want to bet that Johnson will buy of that dealer again?

Those fellows in radio shops who think that, just because they deal out radio supplies to people even as you and me, they know everything that there is to know about radio, should, in many, many cases purchase a beginner's handbook and do a little reading. They should realize, or at least the boss of the shop should, that it is up to them to give advice to people who admit that they know nothing about radio, because the radio salesman is the nearest source of that information. Yet it sometimes happens that the boss of the store knows less than his salesman; which reminds me of the time when the owner of a big store told me positively that a straight-

40 Non-Technical Radio Articles

every month for the beginner, the layman and those who like radio from the non-technical side.

SCIENCE & INVENTION, which can be bought at any newsstand, contains the largest and most interesting section of radio articles of any non-radio magazine in existence.

Plenty of "How To Make It" radio articles and plenty of simplified hook-ups for the layman and experimenter. The radio section of SCIENCE & INVENTION is so good that many RADIO NEWS readers buy it solely for this feature.

Radio Articles Appearing in the September Issue of "Science and Invention" Magazine.

- How to Build a 320-Volt "B" Eliminator By A. P. Peck.
- Construction of Vacuum-Tube Deaf-Phone.
- Radio Control of Passenger Planes in Europe.
- How to Build a Cone Speaker.
- The Radio Fan's Own Page. By Herbert E. Hayden.
- Variable High-Ohm Resistances. By Otto Schrieber.

Save Your Set From Lightning



You never know what lightning will do and any radio set which is without the protection of a lightning arrester is at the mercy of a storm.

The National Board of Fire Underwriters specify that an approved Radio Lightning Arrester must be used with all out-door aerial installations.

Protection is easy. Insure your insurance and save your set with a WIRT LIGHTNING ARRESTER (listed as standard by Underwriters' Laboratories). The cost is a trifle.

THE WIRT LIGHTNING ARRESTER is an approved air-gap type, made of bakelite giving ample insulation, with brass terminals moulded in bakelite, far enough apart so that there is no leakage. A "petticoat" of bakelite shields the Arrester from water and dust. Handsome and rigid. Lasts a lifetime. Easy to install. Full directions on box.

Don't wait for a warning from the elements—it may be too late then. Install the WIRT LIGHTNING ARRESTER—now.

When you install your WIRT LIGHTNING ARRESTER, get a WIRT INSULATOR and prevent leakage along your lead-in wire. It keeps the wire at the proper distance, provides perfect insulation, and prevents wear and tear on the wire by preventing sagging and swaying.

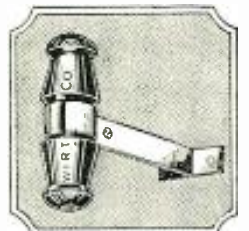

The Wirt Lightning Arrester is listed as standard by Underwriters' Laboratories.

WIRT LIGHTNING ARRESTER \$1.00
WIRT INSULATOR35

Sold by Leading Radio Dealers

WIRT COMPANY
PHILADELPHIA PENNSYLVANIA
Makers of Dim-A-Lite

PATENTS WRITE for our Four Guide Books and "RECORD OF INVENTION BLANK" before disclosing inventions. Send model or sketch and description of your invention for our INSPECTION and INSTRUCTIONS FREE. TERMS REASONABLE. Electrical and Radio Cases a specialty.

VICTOR J. EVANS & CO.
919 NINTH ST., WASHINGTON, D. C.

don't move your set **BIRNBACH** EXTENSION CORD
will move your speaker from room to room or to porch and lawn

20 FEET COMPLETE WITH CONNECTOR 1.00
30 FEET COMPLETE 1.25
50 FEET COMPLETE 1.85

BIRNBACH RADIO CO. 370 SEVENTH AVE. NEW YORK CITY

Insure your copy reaching you each month. Subscribe to RADIO NEWS — \$2.50 a year. Experimenter Publishing Co., 53 Park PL., N.Y.C.

Perhaps you, too, can cut your "B" battery costs in half. Just follow the chart. It gives you the secret of "B" battery economy.

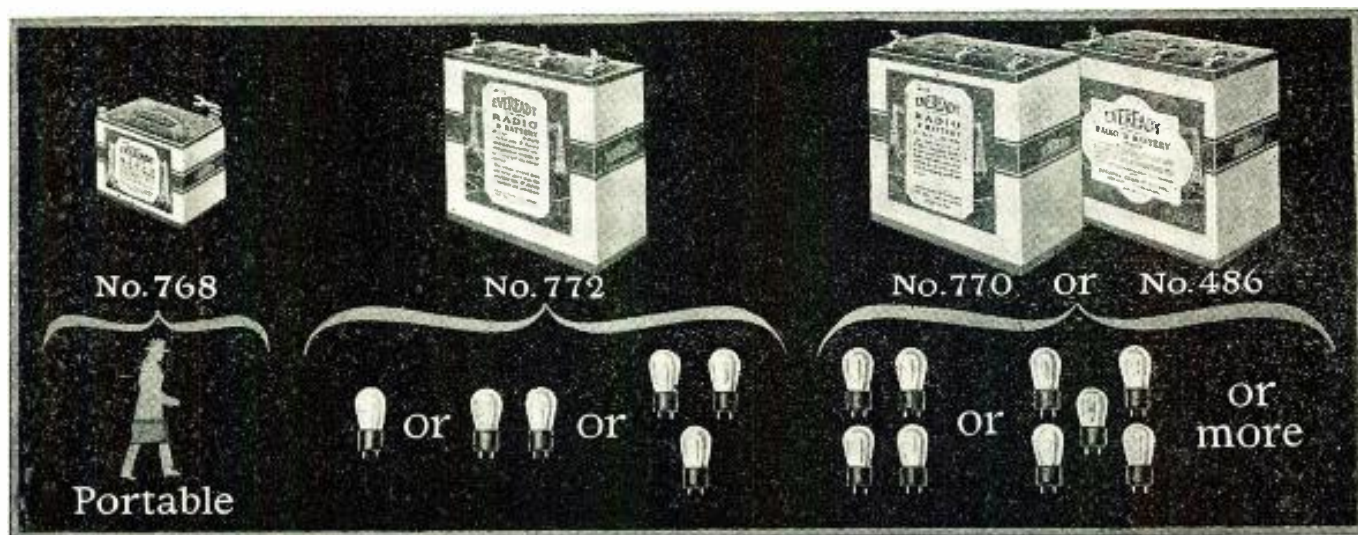

THOUSANDS of people have made the discovery that Eveready "B" Batteries, when used in the proper size, and on sets equipped with a "C" battery*, are a most economical, reliable and satisfactory source of radio current.

Here is the secret of "B" battery economy, reliability and satisfaction:

On all but single tube sets—Connect a "C" battery. The length of service given below is based on its use.*

On 1 to 3 tubes—Use Eveready No. 772. Listening in on the average of 2 hours daily, it will last a year or more.

On 4 or more tubes—

*NOTE: A "C" battery greatly increases the life of your "B" batteries and gives a quality of reception unobtainable without it. Radio sets may easily be changed by any competent radio service man to permit the use of a "C" battery.

Use the Heavy-Duty "B" Batteries, either No. 770 or the even longer-lived Eveready Layer-bilt No. 486. Used on the average of 2 hours daily, these will last 8 months or longer.

These figures are based on the average use of receivers, which a country-wide survey has shown to be two hours daily throughout the year. If you listen longer, of course, your batteries will have a somewhat shorter life, and if you listen less, they will last longer.

Evereadys give you their remarkable service to the full only when they are correctly matched in capacity to the demands made upon them by your receiver. It is wasteful

to buy batteries that are too small. Follow the chart.

In addition to the batteries illustrated, which fit practically all the receivers in use, we also make a number of other types for special purposes. There is an Eveready Radio Battery for every radio use. To learn more about the entire Eveready line, write for the booklet, "Choosing and Using the Right Radio Batteries," which we will be glad to send you on request. There is an Eveready dealer nearby.

Manufactured and guaranteed by
NATIONAL CARBON CO., INC.
 New York San Francisco
 Canadian National Carbon Co., Limited
 Toronto, Ontario

Tuesday night means Eveready Hour
 —8 P. M., Eastern Standard Time,
 through the following stations:

- | | |
|------------------|------------------|
| WEAF—New York | WSAI—Cincinnati |
| WJAR—Providence | WTAM—Cleveland |
| WEEI—Boston | WWJ—Detroit |
| WTAG—Worcester | WGN—Chicago |
| WFI—Philadelphia | WOC—Davenport |
| WGR—Buffalo | WCCO—Minneapolis |
| WCAX—Pittsburgh | WCCO—St. Paul |
| | KSD—St. Louis |

EVEREADY
Radio Batteries
—they last longer

A NEW and BIGGER Bradleyohm for B-Eliminators



Announcing the
Bradleyohm-E
Perfect Adjustable Resistor for B-Eliminators

THE rapid development of B-Eliminators for radio receivers has created a growing demand for an adjustable resistor of high resistance to regulate the plate voltages to the radio set. Bradleyohm-E is a new, large size Bradleyohm of increased capacity and ample range for B-Eliminator service. It is made in several ranges for various types of circuits. If you are building a B-Eliminator, be sure to ask your dealer for Bradleyohm-E of correct range and you will be assured of complete satisfaction regardless of the length of time your B-Eliminator is in service.

Mail the Coupon for interesting literature on Allen-Bradley Perfect Radio Devices

Allen-Bradley Company
287 Greenfield Avenue
Milwaukee, Wisconsin

Please send me your latest literature on Allen-Bradley Perfect Radio Devices including the Bradleyohm-E.

Name.....
Address.....
.....

line-wave-length condenser was the same as a straight-line-capacity condenser. I knew one of his salesmen and he told me that they had to watch the boss all the time or he would pull more bones than a bush leaguer.

There is some doubt whether these words will ever fall on fertile ground and be read for what they are worth. However, there is no doubt but there are many salesmen who should read them carefully and, reading, heed. If you are in the position of salesman and have to give advice now and then, tell purchasers only those facts that you are sure are correct. The majority of people will appreciate a frank, "I don't know" rather than a lot of talk that does not mean a thing and perhaps will cause damage to their receiver or batteries.

Alleviation of Static

(Continued from page 243)

sensitive set with plenty of R.F. amplification, such as the super-heterodyne. The two coils at right angles are prepared for coupling to a common rotor. Each of the stator coils connects to a loop and condenser to make a tuned circuit. One circuit is tuned to the signal plus the static, and

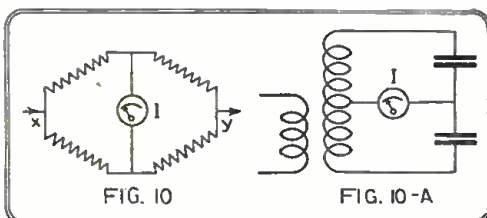

Here is an application of the Wheatstone bridge theory to static alleviation.

the other to the static alone. On obtaining the right polarity of the two stator coils, the rotor coil will adjust for an intermediate coupling between the two former, resulting in equal but opposing induction from the static forces and only one unopposed induction from the signal. (See Fig. 11-A.) Thus the signal alone should get through; and while this does not work out exactly, it does approximate the desired result sufficiently to improve reception. Volume is lost, as in all attempts at static reduction.

The same idea, of course, may be applied

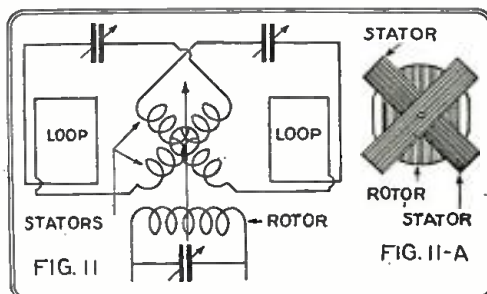

By variocoupler coils like those indicated above in a set using R.F. amplifiers static can be much reduced.

to the use of two antennas. The larger antenna, with the greater static-collecting proclivities, is one that should be used for static alone. It may seem queer that it should not be used preferably for the signal-and-static pickup; but the fact remains that the latter method would not be so successful. In any event, all couplings should be adjusted for best performance.

This scheme, employing two condensers in the case of loop antennas, may be worked out very nicely by using a double-rotor condenser to result in simultaneous tuning. The tuning of the static loop should be slightly

PRECISION "B" Power Unit

50 or 60 Cycle Current



So Efficient
it's sold with a
Money-Back
GUARANTEE
(GUARANTEE IN UNIT)

Here is a "B" power unit that is un-failing. It eliminates the "B" Batteries—doing away with all "B" troubles. A compact, efficient unit that will be working 100% long after the purchase has been forgotten.

The units have variable voltage controls to make them adaptable to any style receiving set. No tubes to burn out—absolutely quiet—100% efficient all the time.

Years of eliminator experience has built "Precision". You are protected by a money-back guarantee.

Write us direct, and give your dealers name and address.

135 Volt Unit	Prices Complete	90 Volt Unit
\$47.50	Ready to Use	\$37.50

PRECISION
Electric Mfg. Corp.
717 East 9th Street
Los Angeles, Cal.

Rubber Covered Insulators



Actual Size

Neat and efficient. For antenna, ground and for lead in wires. Small screw starts readily and makes finished job. Great improvement over ordinary large, unsightly insulators. They keep the wires in place and out of the way. Packed 10 in a box, 25c at your dealers or direct from us.

CULVER-STEARN'S MFG. CO.
Worcester, Mass., U. S. A.

Learn Watchwork, Jewelrywork and Engraving A fine trade commanding a good salary, and your services always in demand. Address Horological, Dept. 5, Bradley Institute, PEORIA, ILLINOIS, for our latest catalog.

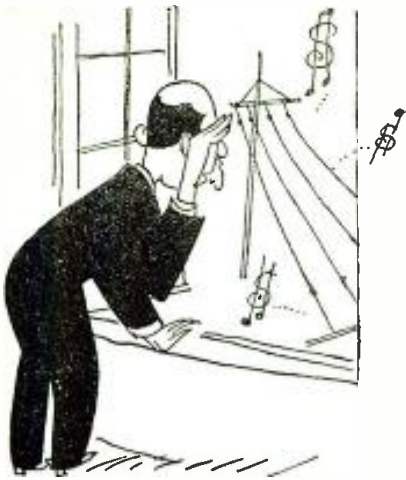

There's a golden tinkle in the air—

Does it reach your ears? All you need is a Rectigon to make music sound like money. And to keep your batteries charged up to their ears with pep. Thus you attain best possible reception at lowest possible cost. Your Rectigon pays dividends quickly in money saved from the service station. And you always have a marvelous power reserve to bring in the best your set can get.

and it comes from charging at home with

No noise as it charges—not a bit of fuss. Not even a murmur that would disturb the mildest slumber.



No acids, chemicals—no moving parts—nothing to spill or burn. No muss, nor worry. You'll have no spoiled rugs, ruined clothing.



Snaps on in an instant—just plug into the light socket, snap on the terminals. Saves service station bother. Spares interruptions caused by absent batteries.



Charges both "A" and "B" batteries—Keeps both packed with power. Bulb is used for "B" battery charging and it is enclosed, like all other parts, in metal, safe from accident. (Rectigon charges automobile batteries, too.)



Safety for batteries and set—You'll not wake to find your battery discharged—that can't happen with a Rectigon attached. Should you tune in without detaching the Rectigon from battery, your set won't be harmed.



No Storage Battery Radio is Complete Without a Rectigon

The Westinghouse Rectigon Battery Charger

©, 1926, W. E. & M. Co.



THE RECTIGON is a superb Westinghouse product. Things you *can't* see, like extra heavy insulation, things you *can* see, like the durably enameled case—all are of highest quality. Westinghouse manufactures also a complete line of radio instruments, and Micarta panels and tubes.

WESTINGHOUSE ELECTRIC & MANUFACTURING CO.
Tune in on KDKA - KYW - WBZ - KFKX

Keep Tubes Full of "Pep"
 - Without removing them from set!

Tubes gradually "run down," as do batteries. Now it is easy to regularly recharge 201-A or UV-199 type tubes, all at once, at home, and enjoy topnotch reception at all times.



The New  **\$3.50**
JEFFERSON
TUBE CHARGER

Tubes soon weaken with use, cut down the power of your set and take more current. To keep tubes always like new, at full efficiency—or to rejuvenate run-down tubes—attach a Jefferson Tube Charger to light socket and connect to set for 10 minutes once a month. The improved reception you get—plus longer life of tubes and batteries—will be worth many times the small price of \$3.50. Guaranteed. Get one at your dealers today.

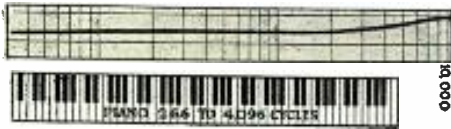

The very nearly straight "curve" of the new Jefferson "Concertone" Sealed audio frequency transformer assures full amplification of all notes—from the lowest to the highest audible to human ears.



Why the newest circuits use—
JEFFERSON
Concertone
 (AL-2 SEALED)

To obtain bass note amplification as well as natural life-like reproduction of all tones, your transformers must evenly amplify every note of the entire musical scale. Jeffersons are extensively used in high grade receivers because they actually make the broadcast sound more natural and life-like. Now, the adoption of the new big Jefferson "Concertone" audio frequency transformers in latest circuits offers further proof that Jeffersons excel in tone quality. These new Jeffersons also increase sensitivity and improve distance reception. Ideal for use with power tubes because of their heavily insulated, extra large core and windings. Each transformer moisture-proofed by sealing it in 3 1/2" square x 2 3/4" high metal case—convenient for "double-decking." List, \$6.00 each. Get them from your dealer. Write for Latest Literature. Other Jefferson Guaranteed Products: Jefferson "Star" A.F. Transformers, \$2.75, \$3.00; Jefferson Tube Rejuvenator \$7.50; Jefferson No. 280 Tube Charger with single socket for large tubes, \$3.50; Jefferson No. 285 Tube Charger with single socket for small tubes, \$3.50; Jefferson Tube Testers (for dealers and experimenters) \$8, \$9. Write for literature.

Jefferson Electric Mfg. Co.
 Largest manufacturers of small transformers
 SO. GREEN ST. CHICAGO, ILL. U.S.A.

off that of the other, for all pickup. Once simplification of control enters into the field, the troubles with many of the static reducers are lessened. In using tandem ("Siamese") condensers, the tuning must not differ too much, since there results the unwelcome possibility of undesired station interference, which is always a live source of worry.

How to Make Radio Pay Your Way
 (Continued from page 205)

The farming community offers another vast field for the enterprising. In the survey made by the Department of Agriculture, it was found that half the radio dealers were making no determined effort to interest the farmers; yet only one farm in ten has radio, and it should be a necessity to the farmer as much as the telephone and the automobile. With 5,900,000 farms waiting for radio, what need be said but "Get busy?"

Catering to women's clubs and to the professional groups who have plenty of money may be well worth your while. Selling tools and supplies to the men who like to tinker is a good side line. Bring over the builders to see your point of view, and you can install radio wiring in new houses. Assisting wealthy experimenters falls to some lucky fellows.

RADIO WRITING

Radio writing for publication is common enough on the technical side, but how about the human interest? When a vessel arrives at port, see if you can get a story from the chief operator to sell to some paper; there is frequently good money in this, especially if it is a scoop.

Lecturing, radio instruction, advertising, photography, are yielding incomes to men who can utilize their knowledge of radio. There are schools for operators, for set builders, and for radio service men, the latter, especially, a source of great possibilities. (Continued on page 268)

A CRYSTAL DETECTOR



THE Grand Mogul "B" UNIT



\$21.50 NEW

Grand Mogul Complete
 90 volt type for use with 1 to 5 tube Receivers

\$26.00

Grand Mogul Complete
 135 Volt Type for 5 tubes or more. 5% discount for cash with order.

Attach the Grand Mogul to your light socket and you have hum-free power that is permanent, constant and uniform always. You will be amazed at the excellence of the reception this new B-Eliminator affords.

Guaranteed

The Grand Mogul is the last word in B-Eliminators. Uses specially designed, guaranteed Mogul tube. (201-A may be substituted if desired.) Thoroughly guaranteed to furnish lasting, trouble-free service. Will supply ample power for 12 tube receivers. Operates on A.C. current, 50 to 60 cycles, 110 volts.

Order Today

We will ship you a Grand Mogul if your dealer cannot supply you. Enclose remittance with your order or we will ship C.O.D. Special discount of 5% for cash with order.

MOGUL ELECTRICAL LABS.

1202 S. PEORIA STREET
 CHICAGO, ILLINOIS

RADIO DEALERS
 WRITE today for your free copy of Albin's LATEST Radio Money-Saver Catalog. More complete than ever! Every page crammed with latest in sets, speakers, kits, parts and accessories. Fast, moving items—unbeatable values—complete stocks—unqualified guarantee—SAME-DAY SERVICE. Buy from Albin and make this the BIGGEST YEAR you ever had.
THE ALBIN RADIO CO. INC.
 221A FOURTH AVE., NEW YORK

PATENTS

If you have an invention and desire to secure a patent, send for our Evidence of Invention Blank and free guide book, "HOW TO GET YOUR PATENT." Tells our Terms, Methods, etc. Send model or sketch and description of your invention for INSPECTION and INSTRUCTIONS.

No Charge for the Above Information
RANDOLPH & CO., Dept. 459 Washington, D. C.

DOUBLE the pleasure to be gotten from your receiving set with the

CORNELL VOLTAGE SUPPLY
(B Battery Eliminator)

Vastly better and richer tone, greatly increased volume and distance, a constant and even flow of power, are some of its many advantages.

And it is an actual money saver also as compared with the use of batteries.

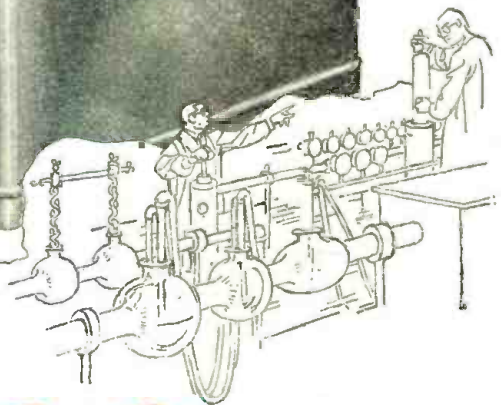
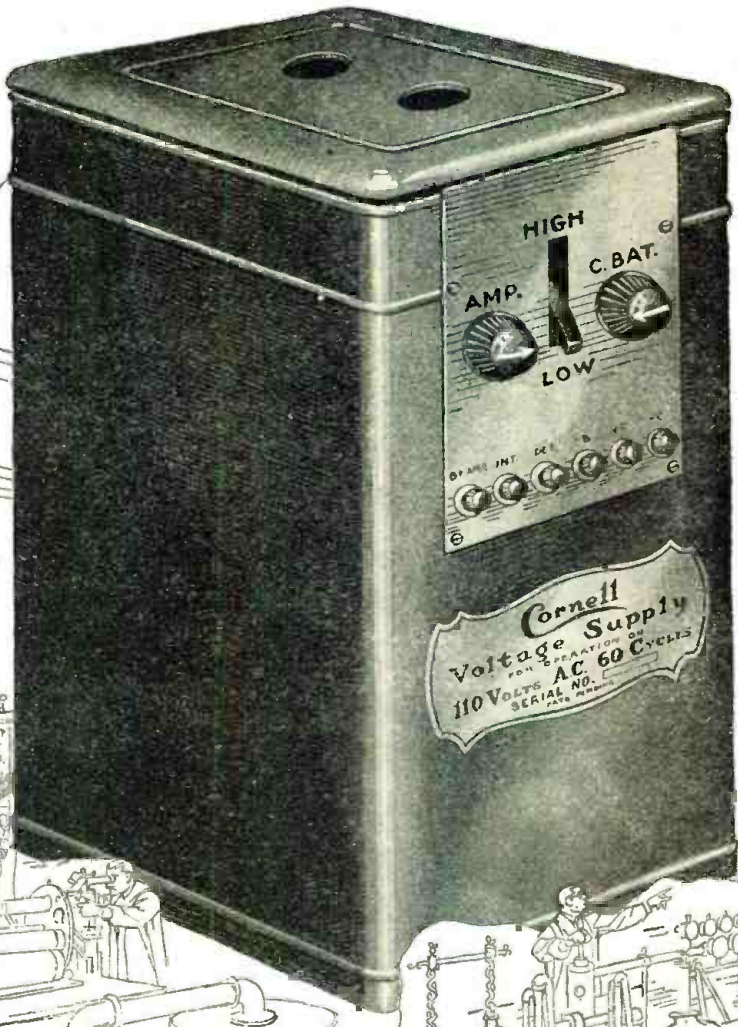
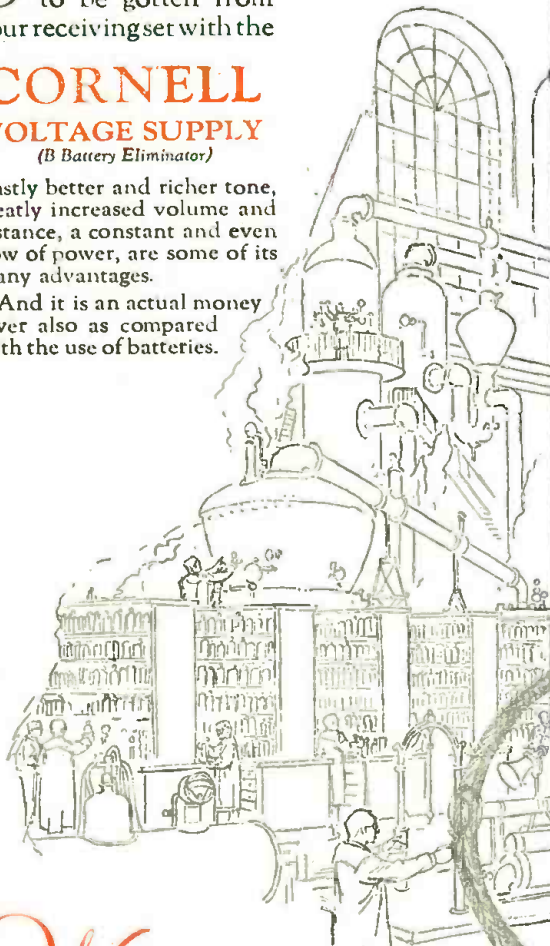

Where Reliability is Born

THE desirability of eliminating the B Battery with its constant "run-down" and other objectionable features, has long been appreciated but it has remained for Cornell engineers to solve the problems in the best, most simple and most truly scientific manner, in the new Cornell Voltage Supply.

Price Type "B" complete in handsomely finished case (with Raytheon Tube and necessary cord and plug), ready for use with practically any receiving set, containing from 1 to 10 tubes, variable radio frequency voltage from 50 to 150 volts (audio amplifier voltage from 100 to 180 volts) and any speaker \$39.50.

Type CB is similar to type B but with the addition of variable C Voltage Supply, giving from one to fifty volts, C voltage \$49.00.
West of the Rockies add \$1.90

If your dealer cannot supply you, write us and on receipt of price we will send the instrument you select, carefully packed express prepaid.

Full descriptive circular will also be mailed on request with name of nearest dealer.

CORNELL ELECTRIC MANUFACTURING CORP.

General Offices:
135 East 58th Street, New York
Cor. Lexington Avenue

\$39.50

F. O. B. New York

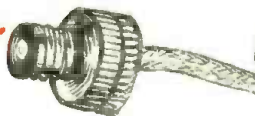
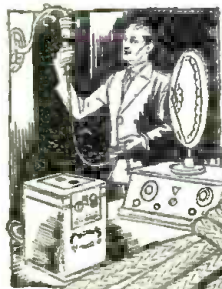

Cornell VOLTAGE SUPPLY
"B" Battery Eliminator

CORNELL ELECTRIC MFG. CO., 135 E. 58th St., Cor. Lexington Ave., New York
Gentlemen: Send me full information regarding your Cornell Voltage Supply (B Battery Eliminator) with name of nearest dealer.

Name _____
Address _____

If a dealer make cross here and receive very special help, etc.

Announcing the *New* Balkite



The New Balkite Charger *With both trickle and high charging rates*

MODEL J has two charging rates. A low trickle charge rate and a high rate for rapid charging and heavy-duty use. Can thus be used either as a trickle or as a high rate charger and combines their advantages. Noiseless. Large water capacity. Visible electrolyte level. Rates: with 6-volt battery, 2.5 and .5 amperes; with 4-volt battery, .8 and .2 amperes. Special model for 25-40 cycles. Price \$19.50. West of Rockies \$20.



Balkite Trickle Charger

MODEL K. With 6-volt "A" batteries can be left on continuous or trickle charge thus automatically keeping the battery at full power. Converts your "A" battery into a light socket "A" power supply. With 4-volt batteries can be used as an intermittent charger. Or as a trickle charger if a resistance is added. Charging rate about .5 amperes. Over 200,000 in use. Price \$10. West of Rockies \$10.50.



Balkite Combination — *furnishes automatic radio power*

When connected to your "A" battery it supplies automatic power to both "A" and "B" circuits. Controlled by the filament switch on your set it is entirely automatic in operation. Can be installed in a few minutes, and can be put either near the set or in a remote location. A permanent piece of equipment, employing no tubes and requiring no replacements. Will serve any set now using either 4 or 6-volt "A" batteries and requiring not more than 30 milliamperes at 135 volts of "B" current. This includes practically all sets of up to 8 tubes. Price \$59.50.

All Balkite Radio Power Units operate from 110-120 volt AC current with models for both 60 and 50 cycles. Prices are higher in Canada.

A new Balkite "B" at \$27.50

Eliminates "B" batteries and supplies "B" current from the light socket. Noiseless. Permanent. Employs no tubes and requires no replacements. Three new models for all types of sets. The new popular priced Balkite "B". At \$27.50 for sets of 5 tubes or less requiring 67 to 90 volts. Balkite "B"-X, for sets of 8 tubes or less; capacity 30 milliamperes at 135 volts —\$42. Balkite "B"-Y, for any radio set; capacity 40 milliamperes at 150 volts—\$69.



Balkite Radio Power Units



Light Socket Radio Power Units

A new Balkite Charger with both trickle and high charging rates. Three new Balkite "B's," including the new popular priced Balkite "B"-W at \$27.50. The new Balkite Combination—with your "A" battery it furnishes automatic power to both circuits.

Now you can operate your radio set from the light socket. Merely by adding the new Balkite Radio Power Units.

You can do it one of two ways as you prefer. By adding a Balkite Charger and Balkite "B," or by simply adding the new Balkite Combination Radio Power Unit.

In either case the result is the same—light socket operation and maximum convenience. And a smooth silent flow of power that gives you a constant quality of reception to be secured in no other way.

Balkite Light Socket Power is noiseless power. There is no hum. It is peak power always. It is never low and never runs down, but is always exactly what is required by the set. It is permanent power. Balkite Radio Power Units are permanent pieces

of equipment. They employ no bulbs, and have nothing to replace or renew. They require no other attention than the infrequent addition of water. They cannot deteriorate from either use or disuse. Other than a negligible amount of household current their first cost is the last. With sets of high current requirements their use is highly desirable for the saving alone. They are simple to install and require no changes in your set.

Over 600,000 radio receivers— one of every ten — are already Balkite equipped. Equip yours with Balkite and convert it into a light socket receiver. Know the convenience of Balkite light socket operation and the pleasure of owning a set always ready to operate at full power.

FANSTEEL PRODUCTS COMPANY, Inc., North Chicago, Illinois

Balkite
Light Socket Operation

BOSCH

Announcing the New

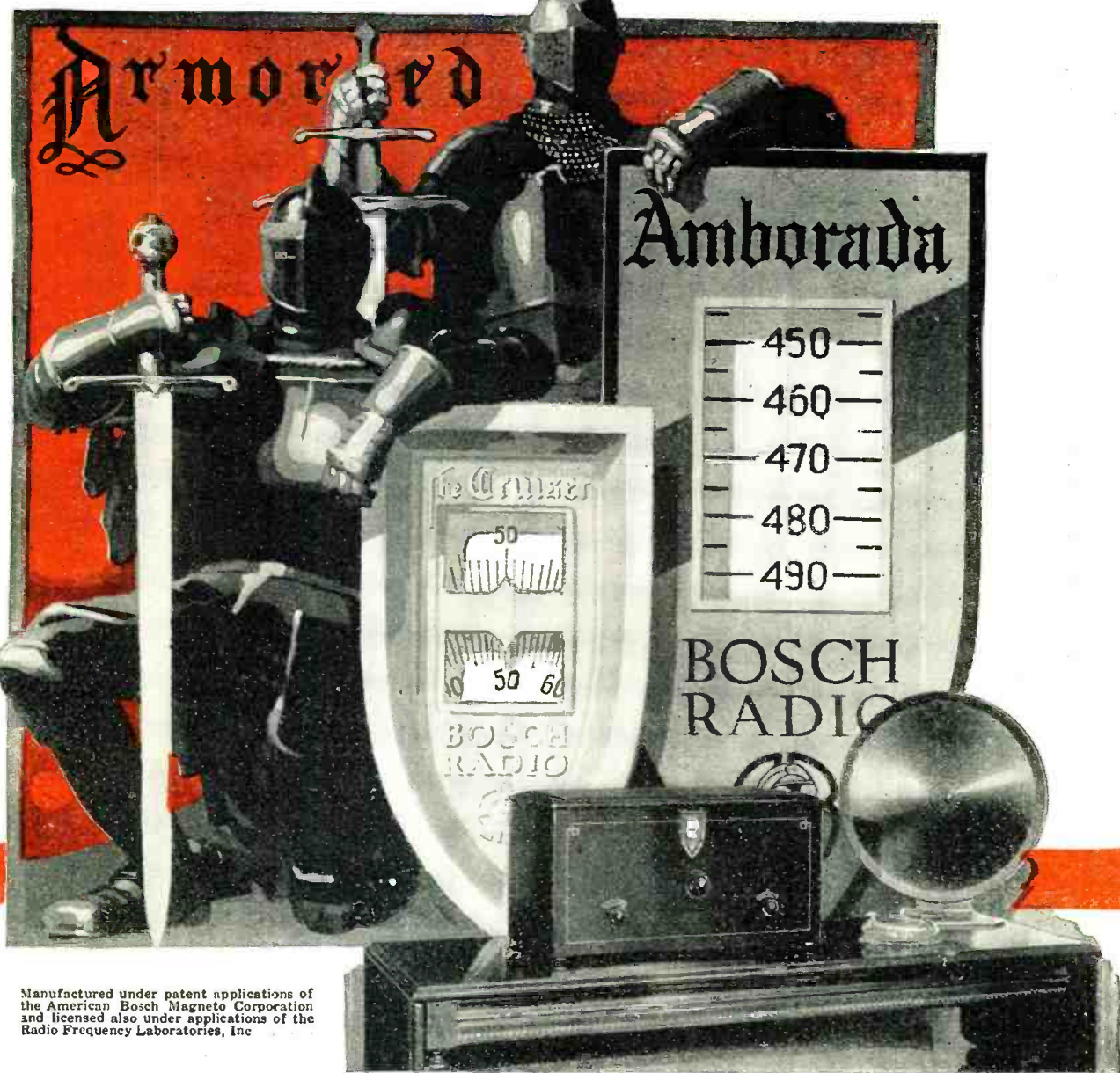

Manufactured under patent applications of the American Bosch Magneto Corporation and licensed also under applications of the Radio Frequency Laboratories, Inc

The Cruiser 5 tubes—\$100.

AMERICAN BOSCH

BRANCHES: NEW YORK CHICAGO DETROIT SAN FRANCISCO

RADIO

ARMORED LINE

Demonstrating its leadership Bosch presents two new Bosch Radio Models—the Amborada and the Cruiser—receiving sets which show a most remarkable advance in home entertainment. The Amborada is the embodiment of perfect radio and quality in furniture. It is a completely armored and shielded seven tube receiver with utmost simplicity of operation. There are but two controls—a Station Selector and a Volume Control. Never was radio made so simple or more enjoyable. The early American period cabinet presents a new and beautiful setting to radio in the home. Ample space is provided for all batteries, chargers or power units with no evidence of its being a radio receiver. No antenna is necessary with this new model. The Amborada will be welcomed by those who have waited for just this development. The Cruiser is a compact

perfectly armored and shielded five tube receiver. Its simplicity is expressed in the Unified Control which gives the advantages of a single station selector for most tuning but when “Cruising the Air” two dial tuning advantages are always present. The Bosch Radio Dealer near you—usually the leader in his community—will explain the great advances Bosch has contributed to Radio. He also sells the Bosch Ambotone Reproducer and the Bosch NoBattery power unit, as well as the many other Bosch accessories. We invite your inquiry if you wish his address. Be sure to hear Bosch Radio before buying any radio equipment.

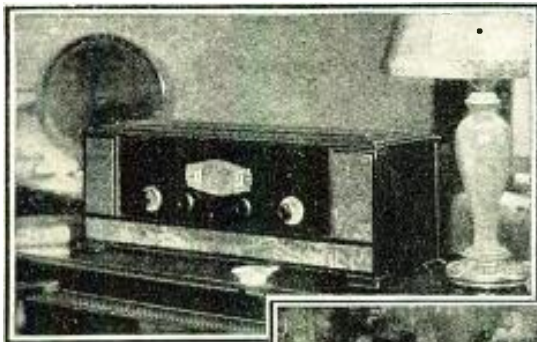

The Famous Model 16 at \$150.

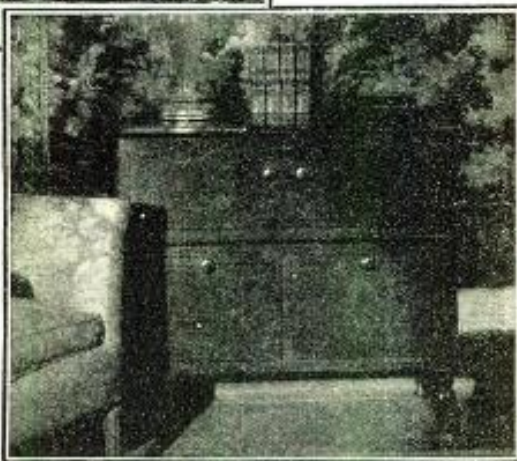

The Amborada 7 tubes—\$310.



All prices slightly higher, Colorado and West and in Canada.

MAGNETO CORPORATION

MAIN OFFICE AND WORKS: SPRINGFIELD, MASSACHUSETTS

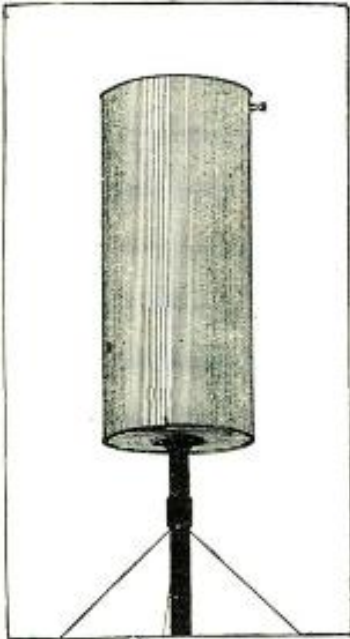

Pat. Pend.

Size 8 in. x 24 in., made of low loss material, black enameled. Complete ready to install. Price \$14.00. Money Back Guarantee.

The Austin Aerial

Improve your radio with this guaranteed aerial.

Receives the same in all directions, Increases selectivity, Eliminates the danger of having wires running over light wires, Will not corrode, Easily installed by anyone, Gives plenty of volume.

This aerial is the only one of the kind on the market, it is manufactured by us exclusively and we **GUARANTEE** it to be as we claim.

MFGD. BY

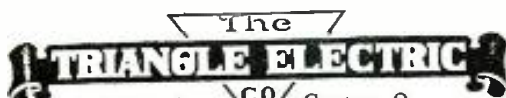

329 Rex Ave., NE. Canton, O.

Illinois Distributor
E. R. BILLINGS CO.,
DECATUR, ILL.

Ask your Dealer or send direct. We will ship to you direct upon receipt of price, or C. O. D. if you desire. Remember the guarantee.



Dealers
Write For
Our
Proposi-
tion

THE TRIANGLE ELECT.
329 Rex Ave., NE. Canton, O.,

Payment Enclosed.

Send C. O. D.

Name

Address

City..... State.....

RADIO PANELS OF GENUINE BAKELITE

Cut, drilled and engraved to order. Send rough sketch for estimate. Our New Catalog on Panels, Tubes and Rods—all of genuine Bakelite—mailed on request.

STARRETT MFG. CO.
520 S. GREEN ST. CHICAGO

Effarsee ANTENNAE

Makes Summer Radio Reception a Pleasure. It gives a maximum of volume, minimum of static and sharper tuning. Place it anywhere—even under the carpet. Sent prepaid for \$4. Write for complete information.

FISHWICK RADIO COMPANY
132 Central Parkway & Elm, Cincinnati, O.

"Lighting Fixtures" READY TO HANG

(Direct from Manufacturer) Completely wired including glassware. Send for new Catalogue No. 27 (Just reduced prices)

Special Proposition to Dealers
ERIE FIXTURE SUPPLY CO.
STATION R ERIE, PA.

PATENTS

DON'T LOSE YOUR RIGHTS Before disclosing your invention to anyone send for free blank form "EVIDENCE OF CONCEPTION" to be signed and witnessed.

LANCASTER & ALLWINE
Reg. Pat. Attys. in U. S. and Canada
270 Ouray Bldg., Washington, D. C.
Originators of the form "Evidence of Conception"

(Continued from page 262)

The average reader of this paper is well qualified to undertake much of the work mentioned in this article. A chance sometimes neglected is found in the radio contests: the amateur, being a skilled man, should easily win in competition against the unskilled in writing for a radio publication.

Exhibiting radio-controlled devices, of all sorts, brings their bread and butter to a number of people at fairs, conventions and on the stage.

The writer has endeavored to list in this article most of the ordinary jobs which the average reader is qualified to handle, and from that, led up to the more technical jobs, the rare and unique. Every idea mentioned is affording a livelihood to a few men; and some to thousands. It is to be hoped this may help many, and give them at least ideas and inspiration.

Constructing a Ripple Meter

(Continued from page 251)

the meter, and we must have the full voltage drop of the battery across the meter. Then, when our meter registers 10, it must represent a certain definite voltage. The value of this can be determined by connecting our voltmeter across the same terminals as the milliammeter.

Let us suppose that the voltmeter shows 15 volts. In this case we can do either of two things; make a correction table, or add resistance in series with the meter so that it will read double-scale.

The former, while accurate and usable, is unhandy. If we increase the resistance of the voltmeter, so that it reads 6 when 12 volts are impressed across it, and so on proportionately, then it is easily read without the use of a table. We can not very well increase the resistance of the meter; but we can put resistance in series with it, which does just as well.

If 10 milliamperes flow thru the meter when 15 volts are placed across its terminals, the resistance of the meter must be 1500 ohms. To give double-scale readings, it must show 10 milliamperes when 20 volts are placed across it. To do this the resistance of the meter circuit must be 2,000 ohms. This can easily be obtained by placing 500 ohms in series with the meter.

If the meter had shown a deflection of 15 when 10 volts were placed across it, it would be necessary to add resistance to make the meter read full scale; that is, so that 10 milliamperes mean 10 volts. In this case the resistance of the meter would be 666 2/3 ohms; it would be necessary to add 333 1/3 ohms, to read even-scale, and 133 1/3 to read double-scale, as in the first case.

HOOK-UP OF METER

Since this meter is to be used to measure ripples, which are of either alternating or pulsating form, the resistance used must be as nearly non-inductive as possible. If copper or resistance wire is used for this purpose, one half of it should be wound in a clock-wise direction on the spool, and the other in a counter-clockwise direction.

For a rough estimate of the amount of copper wire required for a resistance, the following table will be handy:

Ohms per 1,000 feet			
No. 33	206.0	No. 37	523.1
34	260.9	38	659.6
35	329.0	39	831.6
36	414.8	40	1049.

The fuse is a short piece of No. 41 wire. A short length of a broken thermometer is used as a guard for it. This makes a sub-

Insure your copy reaching you each month. Subscribe to Radio News—\$2.50 a year
Experimenter Publishing Co., 53 Park Place, N. Y. C.

Selective Charging

A new feature
in "A" Power Units



Sight Gauge

These switches give complete control

Only 4 connections to make

The Willard "A" Power Unit

& "B" Battery Charger



Plug can be left in lighting socket permanently

Here's an "A" Power Unit you don't have to worry about. It gives you trickle charging for ordinary use of your radio set, and there's a two ampere rate for emergencies.

The colored balls in the sight gauge inform you which rate is needed to keep its genuine Willard Threaded Rubber "A" Battery fully charged at all times. A double throw switch enables you to *select* this rate. Another switch serves to throw the "A" Battery on the set, or the unit on charge, while another takes care of recharging up to 96 volts of "B" Batteries.

WILLARD STORAGE BATTERY CO.
CLEVELAND, OHIO, U. S. A.

The Willard Selling Plan for Radio Dealers

Your local Willard Service Station will act as your jobber on Willard Radio Products.

This means a quick source of supply for strictly fresh material which you can turn over to your customers in the pink of condition.

Your local Willard Service Station also assumes the responsibility for service, if needed.

Months of operation have proved that this plan is effective, and profitable for all concerned.

Willard Radio Products will be advertised exten-

sively this fall. Doubles and full-pages in The Saturday Evening Post and other leading publications.

Have your local Willard Service Station explain the details of this practical plan for advertising and selling radio products. The advertisements are signed:

Sales and Service through
The Willard Battery men
and their
Authorized Radio Dealers

Appropriate signs and window cards will identify you as an Authorized Dealer. Booklets and other valuable selling helps will be furnished.

Your Nearest Willard Service Station is Your Nearest Willard Jobber

This New Magazine Will Increase Your Income!

VOL. 1 NO. 1.

MONEY MAKING

MONEY MAKING

The Magazine of Opportunities
 Edited by Sidney Jernsbach



The CONSRAD COMPANY, Inc.
 NEW YORK

Money Making

Published monthly in the interest of ambitious men and women who want to become independent.

Covers every field of activity from which profit can be derived.

Explains the money-making possibilities in each particular enterprise.

Discusses definite steps to be taken by people adopting a means of livelihood, spare-time work, or a second income.

Has the following special departments:

- Prize Contest Record, a classified directory of current contests.
- The Literary Market, a record of periodicals for writers.
- Opportunities in New Patents, illustrating the latest promising inventions.
- Agents' Opportunities, describing attractive items for salesmen.
- Money-Making Formulas, with directions for preparing specialties.
- Cash Prizes for Money-Making Ideas, announcing the rules for our prize awards.

Publishes feature articles by recognized authorities in many fields, as, for instance, real estate, selling, writing, manufacturing, investments, speculation farming the mail order business, decorating, candy making, needlecraft photography, mechanics, chemistry, window trimming and many others.

Subscription Price, \$2.50 the Year

SECURE A SECOND INCOME

Be independent in business—There are opportunities for big profits everywhere

MONEY MAKING is devoted to specific means and methods of increasing incomes. Hundreds of ways of making money in spare-time work are explained every month.

Read MONEY MAKING and learn how.

25¢ ON ALL NEWSSTANDS

Ask your newsdealer for a copy to-day.

Published and Distributed by

The CONSRAD Company, Inc., 64 Church St., New York, N.Y.

stantial protection and it will not take much larger wire than No. 41, which tends to forestall any attempt to over-fuse. The end caps are made of copper tubing, about 3/16-inch long and closed on one end with a ball of solder. The fuse wire is bent over both ends of the tube. The ends are then wrapped with several turns of tin foil and the caps pushed on. The balls of solder on each end snap into copper strips which act as both supports and contacts. This fuse protects the meter in case the condensers break down.

A double bank of eight 1- μ f., 1750-volt, condensers fills the space back of the switches and the fuse. They are in two groups of four each, paralleled to form two 4- μ f. capacities. Fig. 3 shows these connections, made to take up a minimum of space.

Returning to the panel, the switch above the fuse is used to close the circuit, in one position, and to discharge the condensers in the other. This latter should always be done after taking a reading; as the condensers will often hold a charge for some time, and may give an ugly jolt to the person attempting to use the meter again.

The middle switch, being double-throw, cuts out either bank of four condensers. When this switch is open the two banks are *in series*, and the total capacity reduced to 2- μ f. This is for the purpose of reducing the charging current, and allows the use of a smaller fuse. The meter, at the lower frequencies, will be more accurate with 4- μ f. in series, obtained by shorting either bank, than with 2- μ f.

The upper switch short-circuits the meter and protects it from the jolt of the charging current.

USING THE METER

A small transformer permits listening to the ripple with head-phones or loud speaker. The phones should be used only when testing the filter or generator on a resistance load, such as lamps. Also be sure that the phone terminals are on the negative side of the line. Do not attempt to use them when the meter is connected to a transmitter, or when there is danger of high frequency.

The transformer is mounted behind the panel above the phone jack. It is carefully separated from all high-voltage leads, except for the primary, by a partition. This transformer may be easily made; 1-1 ratio will do, and not more than 75 turns, iron-cored. In place of the transformer, the resistance for the meter may be used, if it is under 100 ohms. The phone leads may be tapped across it; but this is dangerous, as the phones will not then be protected from the high-voltage supply.

In using the ripple meter, first see that the condensers are short-circuited. Then connect the filter or the generator to the terminals A and B; B should be the negative. If the phones are to be used, the load must pass through C. (See Fig. 4). When these connections are made we are ready to take our readings.

See that the meter is short-circuited. Open the switch that cuts out one bank of the condensers, to reduce the initial surge. Now close the circuit with the lower switch, and short one bank of condensers controlled by the middle switch. Open the switch that shorts the meter and take the reading. This reading will be one-half the ripple voltage, and one-quarter the fluctuation, in cases where the meter reads double-scale; and will be the actual ripple and one-half the fluctuation where the meter reads even-scale.

In disconnecting the meter, open the lower switch and discharge the condensers. Then remove the terminals.

For comparing the effectiveness of R.A.C. filters and the raw ripple of D.C. generators

An
amazing
Advancement!

Aristocrat
Pointer Knob

Aristocrat
E-Z TOON
Vernier Dial

Aristocrat
E-Z TOON
Vernier Pointer

The
NEW "Aristocrat"
Vernier Port Dial

SINCE the birth of radio, Kurz-Kasch has been foremost with all important improvements—the leader in the field of plastic mouldings. The name *Aristocrat* has always signified radio parts—dials, knobs, pointers, etc.—of unsurpassed quality and efficiency.

Our newest improvement—the latest addition to the noteworthy *Aristocrat* family is no exception! This Vernier-Port Dial is of Bakelite. It will improve the appearance and efficiency of any set a hundredfold.

The vernier ratio is 14 to 1. There are no gears, no cogs, no chains—no backlash possible. Nothing to wear out or get out of order. Easily installed—in a few minutes! The famous Kurz-Kasch split bushing fits any condenser shaft.

In three beautiful, attractive finishes—black, walnut or mahogany. If you are to build your own radio, be sure to select this *Aristocrat* Vernier-Port Dial if you want and expect best results.

If you already operate a radio with old-fashioned dials—or dials of doubtful quality and origin—replace them with this improved, modern Vernier-Port Dial. You'll be surprised at the difference in appearance, and you will enjoy better reception due to more accurate tuning—bringing in countless stations you've never heard before.

You'll find the *Aristocrat* Vernier-Port Dial at all better dealers—\$2 each—in the color and finish you select!

THE KURZ-KASCH COMPANY, Dayton, Ohio
MOULDERS OF PLASTICS
Offices in All Important Cities

KURZ  **KASCH**
Aristocrat Dials and Knobs



Now you can have Radio at its best summer or any time!

You can at last forget the mechanics of radio, for a simple switch releases all the power you need for any program. Power—clean—constant—abundant! Power that instantly responds to high soprano, and as easily brings you the full resonance of an orchestration!

No Filament To Burn Out

All Majestic "B" Current Supply units are manufactured complete in our factory and are equipped with the famous Raytheon Non-filament Tube. No acids or back surge. Tests of the Majestic "B" oscillograph demonstrate that all A-C hum is entirely eliminated.



Majestic "B" Current Supply

delivers pure direct current—From your light socket

The same electric current that supplies your lights delivers "B" power for your radio. No fuss. No worry. No acids. No "hum". Nothing but reliable, unvarying power direct from your light socket. *And at an average cost of one-tenth cent an hour!*

Economical, powerful—lasts as long as any receiver

Fully guaranteed. Its low purchase cost and the saving it will mean to you in just a few months makes it an investment that soon pays for itself. Don't delay—see your dealer at once or write for free booklet.

Majestic Super "B" Current Supply
Capacity 1 to 12 tubes, including the use of 135-150 volt power tubes.
Price\$35.00
West of Rocky Mts. \$37.50

Majestic Master "B"
Rating 60 mills at 150 volts. Particularly adapted for Radiola 25-28- & 30 and super heterodynes. Will operate on super power tubes UV 171 (180 volts.) Unequaled for sets having very heavy current draw.
Price\$42.50
West of Rocky Mts. \$45.00

GRIGSBY-GRUNOW-HINDS CO.

4572 Armitage Avenue

Chicago, Illinois, U. S. A.

GEM TUBE
A Guaranteed Radio Tube Within Reach of All

A tube for a dollar of \$3 value. A trial order will convince you as it has thousands of others. (Blue or Silver with Bakelite Base). Send your orders at once. Orders sent C.O.D. with UV. or UX Bases parcel post.

Types \$ 401A \$ 400 499 499A Each

With Stand. and Base or UX Bases

Dealers, Write for Discounts

GEM TUBE CO.
(Dept. N.) 200 B'way, N. Y. City
220 So. State St., Chicago, Ill.
Lafayette Bldg., Detroit, Mich.

AEROVOX
"Built Better"

RAYTHEON CONDENSER BLOCKS

AERVOX products are used by over 200 of America's Radio Manufacturers. AERVOX Radio Condensers are approved by E.I.L. and Yale Universities.

AERVOX WIRELESS CORP.
422-423 Broadway St., New York

Branch Offices:
St. Louis, Mo., 2141st Street Building
Chicago, Ill., 117 W. Franklin Boulevard
Los Angeles, Cal., 214 N. San Pedro St.

this meter will fill the bill nicely. It is not sufficiently sensitive, except with the phones, to do much good on the filtered generator. The cost of this meter was a few cents over \$9.

CALLS HEARD

W. A. SHANE, 12 CHARLES ST. E., TORONTO, CANADA, C3ML

40 meters—using series feed direct coupled Hartley: 3 ckt tuner, 1 sp A. F. A.
Nov. 25—2xaf (phone); nkf; (4oy); m3dtx, qra?; (5aqw); (7rl), qra crd?; (9aot).
Dec. 3—3bhy; 1aya; 5apg; 6cdw; 7uj; 9dac.
Dec. 4—1bdv, 80 meters; 1bke.
Dec. 5—(1awn, r2 to r5); 6tj; (9aqf, r5).
Changed to shunt feed, loose coupled Hartley, 50-watt tube, input never exceeded 32.5 watts.
Dec. 8—(5zai, r3); (9ff, r4).
Dec. 9—(5tg, r4).
Dec. 14—Nism, qra?; (9dbj, r5).
Dec. 15—Pow—20 meter band, qra?; aga—20 meter band, qra?.
Dec. 16—Wva, qra?; aga,r1; nkf,r7; 2xaf; 9ek, r4.
Dec. 17—In operating room of station CKCL, during 7.00-8.00 p. m. broadcast, same set as above using ground only within five feet of transmitter.
Wiz, u2anc, u2cxy, u2cty, u2hy, u3bwt, u3jo, u3cel, u5atx, gcc, u9ejj, 9dol, kdka.
Jan. 11—(6vr,r5).
Jan. 13—(nfv,r7).
Antenna used for reception and transmission inverted L as used for CKCL on 840 KCS, working on H. F. transmitter between 5th and 6th harmonic, using radiator steam pipes, steel frame of building, etc., for ground. C. P. n. g. for H. F. work. Pse QSL. All crds answered.

D. CASON LAXT, BISBEE, ARIZONA, 6CUW

1fx, 1rd, 1xz, 1yh, 1aao, 1ahg, 1ahl, 1ail, 1ajp, 1aof, 1bay, 1bes, 1hga, 1hlf, 1bpb, 1bvc, 1xm, 2ev, 2fn, 2mn, 2nw, 2uk, 2zv, 2acs, 2akv, 2am, 2ahm, 2auh, 2brc, 2cel, 2cxy, 3eb, 3ch, 3cki, 3ckp, 4bu, 4ch, 4fa, 4fj, 4fl, 4fm, 4fs, 4io, 4iu, 4iz, 4ao, 4rm, 4rr, 4sa, 4sb, 4si, 4we, 4aa, 4aa, 4ah, 4ak, 4ax, 4ew, 4gi, 4he, 4jf, 4mi, 4nj, 4nq, 4qk, 4qx, 4qs, 4rg, 4sh, 4tk, 4ux, 4va, 4yd, 4aaq, 4acl, 4agi, 4ahp, 4akl, 4alm, 4alz, 4amw, 4apm, 4aqu, 4arb, 4atf, 4atk, 4atx, 4atz, 4bh, 4bq, 4ej, 4il, 4il, 4lr, 4ml, 4no, 4pz, 4gg, 4sk, 4tq, 4adw, 4aff, 4al, 4ano, 4asd, 4asm, 4awt, 4bav, 4bde, 4bh, 4bh, 4bh, 4bji, 4bbs, 4bst, 4btm, 4buc, 4bvf, 4ccl, 4cco, 4ccp, 4cct, 4cfr, 4cfs, 4cfe, 4cnd, 4cqw, 4cqa, 4csw, 4crl, 4cux, 4dag, 4daq, 4db, 4db, 4zac, 4ac, 4gy, 4hb, 4nx, 4oc, 4rl, 4tq, 4uj, 4zq, 4agi, 4ajh, 4alk, 4ahf, 4aj, 4ay, 4by, 4bc, 4es, 4fl, 4gi, 4pl, 4sqd, 4rt, 4sv, 4xi, 4zi, 4zu, 4adg, 4ago, 4air, 4aly, 4aub, 4aul, 4avd, 4avk, 4axs, 4bcv, 4bh, 4bh, 4bh, 4bh, 4bh, 4bh, 4bh, 4brw, 4bhr, 4bz, 4chi, 4cbr, 4dae, 4dgp, 4dip, 4dno, 4bv, 4ds, 4fa, 4hp, 4kb, 4nl, 4oo, 4wo, 4adk, 4aji, 4aim, 4akb, 4aot, 4asw, 4atq, 4ayi, 4ayn, 4bkk, 4bos, 4hou, 4bqh, 4brq, 4bvh, 4bwb, 4bwn, 4hwo, 4cap, 4cbf, 4chy, 4cdw, 4civ, 4ckm, 4cld, 4ctg, 4ctr, 4cvm, 4cwn, 4dac, 4deq, 4dez, 4dge, 4dke, 4dnb, 4dng, 4dth, 4dte, 4dyy, 4ebv, 4ebx, 4ecc, 4efy, 4ejj, 4eky.

CANADIAN: 3aa, 3kp, 3ni, 3oh, 4de, 5hf.
MEXICO: 1k, 9a, 5c.
Nkf, npu, nisp, wiz, gdvb, cpfhe?
All on 40 meter band. (ld to qsl to anyone and wl appreciate rpts on mi sigs. 73s to all.

An Ultra-Modern Radio Factory

(Continued from page 222)

ing touches are put on the various parts thus made.

BELT-CONVEYOR SYSTEMS

On the second floor we find that the finest kind of efficient production methods are employed in the assembly of parts into the thirty odd units which are built into the receiver. The manufacturer has found it necessary to design and develop many special machines for this work, such as coil winders, rheostat winders, variable-condenser stackers, automatic riveters, engraving machines, as well as a great variety of standard small machine tools.

The third floor of this modern factory is given over to the final assembly, testing and packing departments. Here the latest types of continually-moving belt conveyors play a big part in speeding up these activities. Individual benches are located on both sides of the belt conveyor, and operations are laid out to permit assemblers, working in pairs, to remove a receiver from the conveyor, perform their operation and return it to the belt

Insure your copy reaching you each month. Subscribe to Radio News—\$2.50 a year. Experimenter Publishing Co., 53 Park Place, New York City.

KELLOGG

Flawless Reproduction

Radio

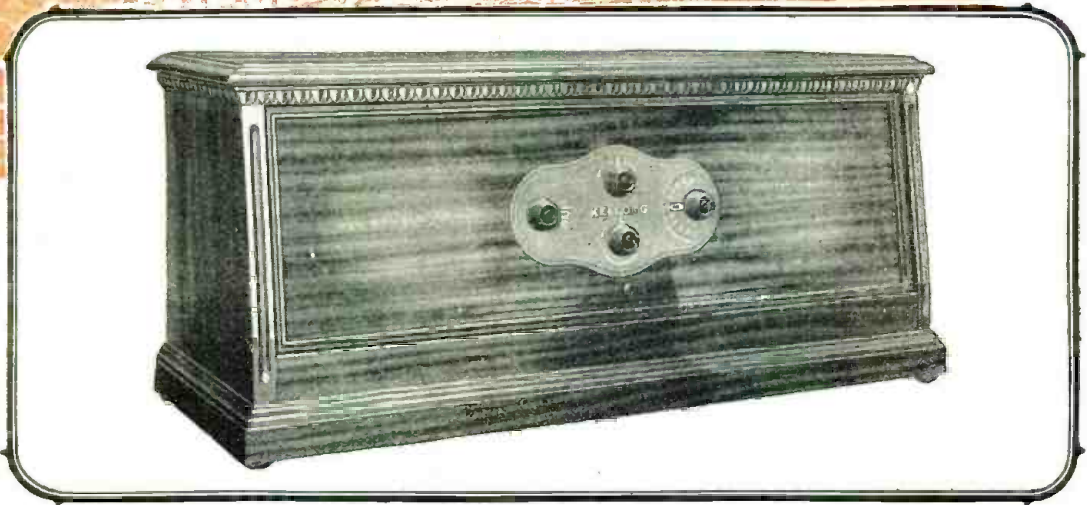

Licensed under application for letters patent of Radio Frequency Laboratories, Inc. [R. F. L.]

Backed by 29 Years' Telephone Experience



Model 508 includes the apparatus of the table model and the famous Kellogg speaker, with ample space for all batteries or power supply units.

FLAWLESS, faultless radio reproduction such as Kellogg has attained can come from experience alone. In radio set building, nothing — absolutely nothing — matches experience.

Model 507 receiver is the finished result of our 29 years' experience in voice transmission — a set that cannot squeal or howl — that brings them in with a "punch" to delight the most critical radio fan.

Heavy shielding around and between the coils prevents interference, and three stages of radio frequency give maximum range and selectivity. Take our word for it — here's a receiver that's as perfect as can be made.

Mail this Coupon Now for full details of the new Kellogg 507 receiver with the refinements and improvements possible only from an experienced institution like Kellogg.

Kellogg Switchboard & Supply Co.
1066 W. Adams St., Dept. 1-1, Chicago

DEALERS FRANCHISES
Dealers now receiving franchises. Write and let us tell you all the things we are doing to make Kellogg sets sell BIG.

Mail the Coupon Today

Dept. 1-1
Kellogg Switchboard & Supply Co.
1066 West Adams St.
Chicago, Illinois

Please send me full information on the Kellogg Six Tube Receiver, model 507, and on the console model 508.

Name _____

Address _____

If a dealer, interested in a Kellogg Sales Franchise, check here

“MOST POWERFUL IN THE WORLD”

Navy Model

UNIVERSAL TRANSOCEANIC

Design by
CHAS. R. LEUTZ

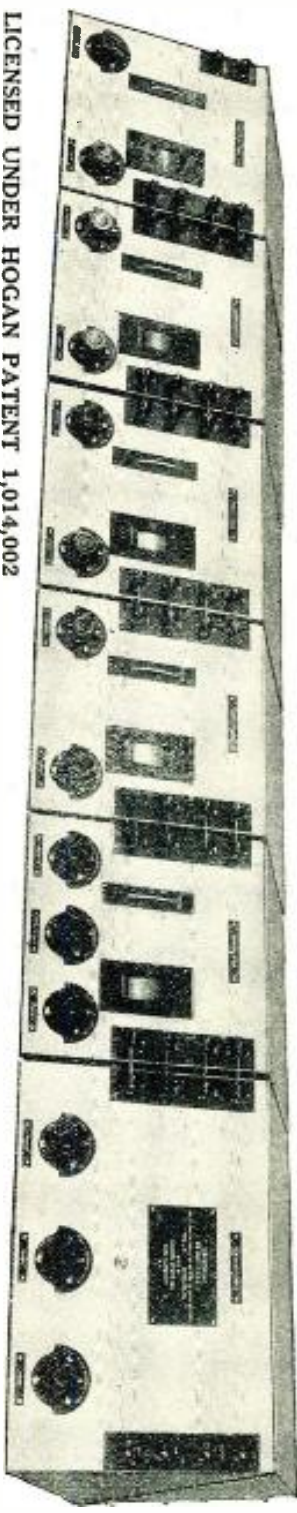

LICENSED UNDER HOGAN PATENT 1,014,002

Wavelength Range 35 Meters to 3600 Meters

Full details are given in our 88 Page Catalog Free.

Wire or write for your copy today.

GOLDEN-LEUTZ, Inc., Sixth & Washington Aves., Long Island City, N. Y.

MANUFACTURED BY
CABLE “EXPERINFO”

The Universal Transoceanic is supplied completely constructed and laboratory tested and is also supplied in Kit form, all parts ready for assembly. The complete set of Constructional Blue Prints covering all mechanical, electrical assembly details, wiring diagrams and instructions will be mailed upon receipt of \$5.00 net.

which carries it on to the next pair of workers.

Thus, following the most advanced factory policy, the embryo receiver is moved systematically and efficiently from the first to the final assembly, and then to the final inspection and test departments. Here the receiver is actually tested on broadcast reception, and a record made of the dial readings for several stations. This record, which accompanies the receiver, serves as a guide to the buyer in the operation of his receiver, though there is little variation between any two of the same model, owing to the high degree of standardization.

After the reception test, the receiver is returned to the conveyor, and proceeds to the cabinet assembly department, where it is mounted in the cabinet and prepared for packing. Two cartons are used, the outer



The molding department makes the different insulating composition parts, using thermostatically-controlled presses.
Courtesy of A. H. Grebe & Co., Inc.

one being a specially-constructed air cushion container which prevents damage in transit.

BROADCASTING AND EXPERIMENT

The fourth floor of this factory is devoted to the activities of the engineering staff and to two broadcast stations which the company maintains. Here, also, are two experimental stations through which this firm keeps in touch with amateur operators throughout the world. In connection with the broadcasting we find on this floor well-appointed reception rooms, large and small studios, control rooms, and the office of the broadcast officials.

Mounted on the roof are three lattice-type towers which permit the use of horizontal aerials two hundred feet above the ground. The engineering skill employed in the construction and operation of this station is evidenced by the fact that although the power used is only 500 watts, programs from these studios have been heard in nearly every part of the world. Broadcast listeners in Australia, for instance, frequently write and even cable their applause.

HIGH ACCURACY REQUIRED

It is difficult, in so brief an article, to do justice to the scientific care which is such an important part of the building of the receiver. The corps of inspectors, for instance, is approximately twice as large, in relation to the production force, as is customary in the automobile industry. These inspectors are really expert at their respective jobs, and do nothing but test and inspect various parts and units of this receiver.

The testing of the receiver involves the use of hundreds of specially designed instru-

G-S SILK CORE CRYSTAL DETECTOR

PRICE \$1.50

Write for new descriptive folder.

Man'fd by G-S Radio Res. Lab., 1269 Cochran Ave., Los Angeles

Distributors: Scott Sales Co., 443 S. San Pedro St., Los Angeles

C. L. PARKER

Ex-examiner U. S. Patent Office
Attorney-at-Law and Solicitor of Patents

McGill Building, Washington, D. C.

Patent, Trade Mark and Copyright Law

Centralab Radiohms, Modulators, Potentiometers or Rheostats are standard on 69 leading radio sets. Ask your dealer, or write for descriptive literature.

Central Radio Laboratories
19 Keefe Avenue Milwaukee, Wis.

Centralab

64 Illustrated Pages of Radio Bargains!

Write for Catalog Today

RANDOLPH RADIO CORP.
159 N. UNION AV. Dept. 2 CHICAGO, ILL.

Insure your copy reaching you each month. Subscribe to Radio News—\$2.50 a year. Experimenters Publishing Co., 53 Park Place, N. Y. C.

Radio batteries with a name and a reputation

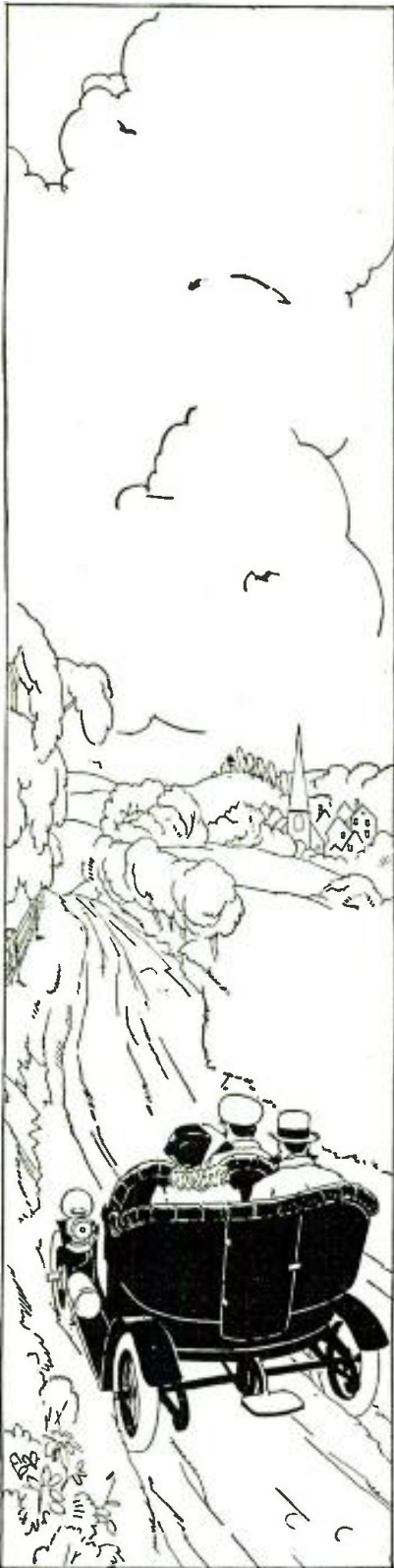

THERE is one safe guide to follow in buying radio storage "A" and "B" batteries—the name of the battery and the reputation of the manufacturer.

More than twenty years ago, Prest-O-Lite gave the motor-car its first really dependable light, and since that time Prest-O-Lite has more than kept pace with the ever-changing motor industry.

When the miracle of radio came, it was only natural that Prest-O-Lite should make batteries especially for this new industry; batteries which because of their unexcelled quality have added to the reputation and prestige of the name Prest-O-Lite.

These batteries were perfected in the world's largest electro-chemical research laboratories. They are made of the finest materials. Every user of a radio can depend upon Prest-O-Lite Radio Batteries to deliver their rated ampere-hour capacities and to insure good clear reception.

Prest-O-Lite Batteries are attractively priced from \$4.75 up. It is unwise to take a chance on batteries of unknown make. Ask for Prest-O-Lite.

THE PREST-O-LITE CO., INC.
INDIANAPOLIS, IND.

New York San Francisco

In Canada: Prest-O-Lite Company
of Canada, Ltd., Toronto, Ontario

Send for free booklet

"What every owner of a radio should know about storage batteries" is a little booklet which every radio fan will find interesting and helpful. It is crammed full of hints that will bring surprising radio results—and save you money. It's yours for the asking—without obligation.

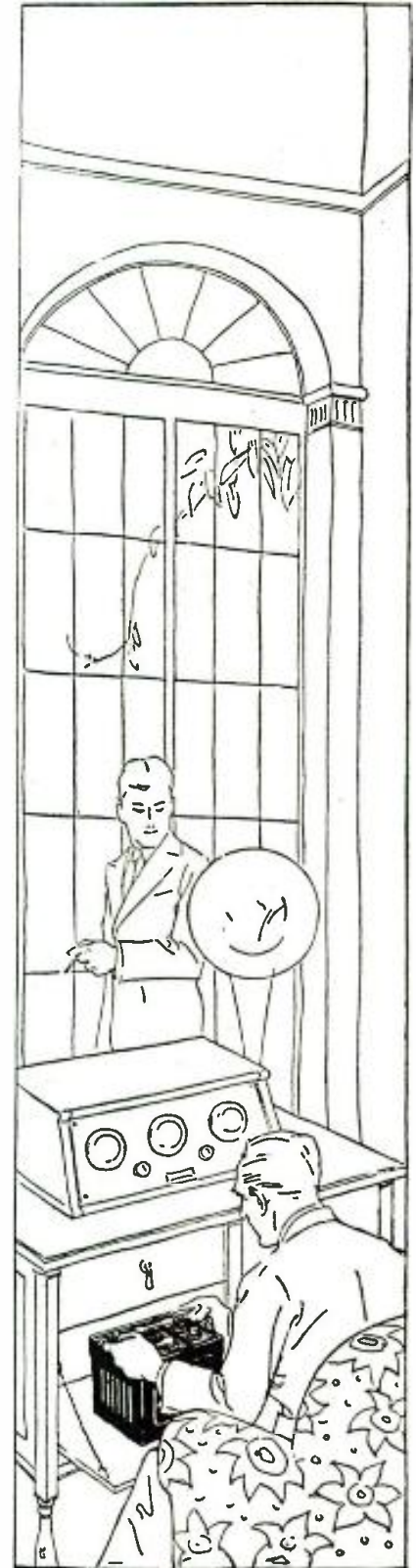

Designed especially for radio

Prest-O-Lite

STORAGE BATTERIES FOR
MOTOR-CARS AND RADIO



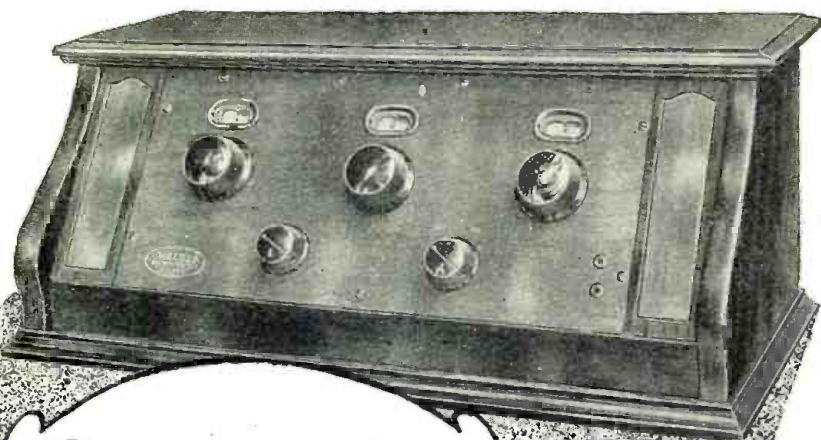

Radically new Circuit greatly increases Power and enhances tone Quality

The Chelsea Truphonic Six utilizes an entirely new and different system of audio amplification—a system as far in advance of that heretofore employed as the orthophonic principle in talking machines is superior to former phonograph reproduction. A power tube may be used in the last stage of the Truphonic, thus obtaining tremendous amplification. Tone quality is stabilized while the whole tone range is increased to its full limits, enabling you to enjoy the maximum capabilities of any loud-speaker.

Ask Your Dealer to Demonstrate or Write Us Direct

CHELSEA RADIO CO., Chelsea, Mass.

Other Chelsea Sets \$26 and \$50—each a leader in its class. Send for details.



The new **CHELSEA** Truphonic Six

ments. The accuracy of these tests is guaranteed by the fact that engineers, in their laboratories, daily test and check over these various electrical testing instruments. Even the man who is not a radio enthusiast is certain to appreciate the precision and care which is evidenced in every part.

Radio Set Owners' Information

(Continued from page 216)

a plug may be connected to the aerial binding post of the receiver. The accompanying illustration shows just how this is done. Note that there is no direct connection to either of the electric-light wires. The energy pick-up is through the capacity existing between the insulated wire and the electric-light wires.

A Combined "B" Eliminator and Power Amplifier

(Continued from page 241)

amplifier through an audio transformer in the usual manner. The output of this tube passes to the jack at the upper right, to which the loud speaker is connected, through a 1:1-ratio transformer.

A SHIELDING DEVICE

The success of a device of this kind depends considerably upon the disposition of the parts and the shielding of one part from

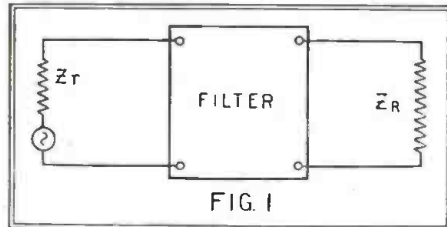

An eliminator corresponds to a transmission system in which the impedance of the source of emf is Z_t and the impedance of the receiver of energy is Z_r . In the eliminator Z_t is the impedance of the input transformer and the receiver; Z_r is that of the receiving set.

another within the containing case. There are other features which demand consideration and require special arrangements. For instance, difficulty may be experienced from the antenna effect of the lighting system of the building in which the device is located,

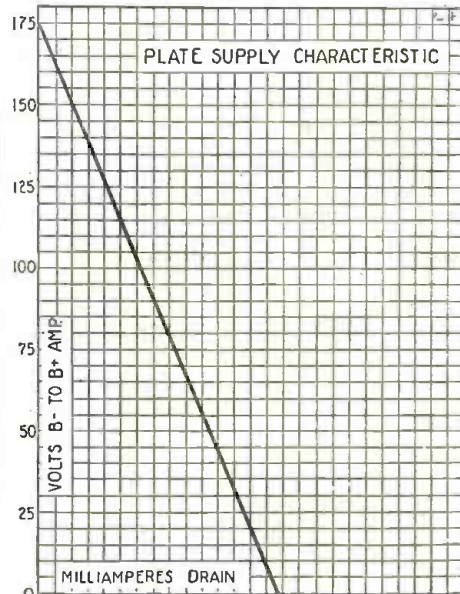

This chart shows how the output voltage of the eliminator here described varies with the load put on it.

100 Volt Storage "B" Battery \$10

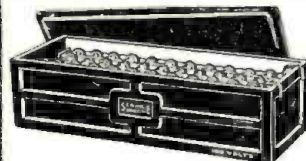

Everybody can now enjoy the benefits of Storage "B" Batteries—more power, quieter reception, greater economy. Rubber case prevents leakage or shorting. Easy to recharge. Will last for years with ordinary care.

SERVICE Rechargeable "B" Batteries in all-rubber cases
 50 VOLT \$5.50
 100 VOLTS \$10.00
 125 VOLT \$12.50

Prices in Canada:

50 Volt . . \$7.75
 100 Volt . . \$14.50
 125 Volt . . \$17.00

SERVICE "A" Batteries
 Indestructible rubber case, 2 year guarantee.
 6Volt. 100amp. hr. \$14.00
 6Volt. 120amp. hr. \$16.00

SERVICE Double-Duty CHARGER

Charges 6-volt "A" or Auto Batteries or up to 125 volts of "B" Battery IN SERIES. Noiseless in operation. Extremely economical. The height of convenience.



Complete with Bulb \$14.50

SERVICE BATTERY CO. of Canada, 137 Roncesvalles Ave. Toronto, Ontario
SERVICE BATTERY CO.
 704 East 102nd Street Cleveland, Ohio

1927 MODEL

*The Newest Up-to-the-Minute Radio Set
—It Has Never Been on a Dealer's Shelf*

SOLD ON A GUARANTEE OF SATISFACTION OR MONEY BACK

BST-6

*Volume
Control*
—
**180 to 550
Meters**
—
*Perfect
Calibration*



*B-Beauty
S-Selectivity
T-Tone purity
6-6 tubes*

THIS marvelous six-tube tuned radio frequency receiver is Self-Equalized and built of low-loss materials throughout. Its clear, rich tone of astonishing volume is a revelation. The circuit consists of two stages of tuned radio frequency, tube detector and three stages of balanced audio amplification. Air cooled rheostats and universal sockets are used.

Lubree modified straight line wave variable condensers are employed, insuring separation of the low wave length stations. **PERFECT CALIBRATION—STATIONS ONCE TUNED IN CAN ALWAYS BE LOGGED AT THE SAME DIAL POINT.**

The BST-6 works best with a 75 to 100 foot aerial, 6 volt "A" storage battery, two 45 volt "B" batteries, 4½ volt "C" battery, six 201-A tubes and any good loudspeaker.

Specifications

Bakelite Panel, Walnut Finish—
With Etch-O-Gravure and Gold Decorations—
Bakelite Sub-Base—
Kurz-Kasch Bakelite-Walnut Pointers; Gold-filled, to Match—
Kurz-Kasch Bakelite Gold-filled Rheostat Knobs—
Lubree Straight Line Wave Variable Condensers—
Special Corkoid Coils; Highly Concentrated Field—
Shore Audio Transformers—
Caswell-Runyan Two-tone Walnut-Finished Cabinet.
New Dubilier Grid Condenser.

LOG OF BST-6

**Taken on a Fifteen Foot Aerial In One-half Hour by
Al. Kraus, 996 Aldus Street, New York City.**

WSBC, Chicago, Ill. . . . 10	WGY, Schenectady, N.Y. 50
WBBR, Rossville, N. Y. . 16	WMAK, Lockport, N.Y. 51
WEBH, Chicago, Ill. . . . 49	WMSG, New York City 11
WHT, Deerfield, Ill. . . . 55	WOC, Devenport, Ia. 85
WCCO, St. Paul, Minn. . 61	WFAA, Dallas, Texas . . 78
WSB, Atlanta, Ga. 66	

'SELECTIVITY

I live within four blocks of WLWL, and since the opening of this station have had great difficulty in choking them off my old set. Even after employing a wave trap I could still hear WLWL around the entire dial and was told by several friends that living so near this powerful station it would be impossible to entirely cut them out with anything less than a super-het. It was a very agreeable surprise, therefore, when I installed my new BST-6, to find that while WLWL came in on 25 I could tune in WRNY on 21 and entirely cut out WLWL. This is certainly real selectivity.—F. S. Clark, 350 West 55th Street, New York City.

Guarantee**Satisfaction or Money Back**

Each receiver is tested and retested, boxed and inspected before leaving factory, and guaranteed to reach you direct in perfect condition.

Workmanship throughout guaranteed the best. Assembled by experts.

Immediate Delivery

**Direct from factory to you
Immediate Delivery**

\$40.00

SAFETY FIRST!—Why buy obsolete models, or radio failures at department store "bargain sales" when a BST-6, the latest achievement in radio, can be bought direct from the factory with no department store profit added? Here is a real bargain, sold you with a guarantee of satisfaction or money back.

Send Check or P. O. Money Order to

GUARANTY RADIO GOODS CO.

143 West 45th Street, New York City

The new SONOCHORDE CONE

The Speaker of Eloquence

Greater tone range, detail, naturalness and volume is yours with the new Sonochorde—the Cone that last year took New England by storm. Equipped with powerful, patented amplifying unit. Adjustable. Silk wine-colored cone. Beautiful mahogany semi-gloss finish. Protected back. Suitable also for wall or standard mounting. Comparison is invited.

Write for complete story on Sonochorde.

BOUDETTE MFG. CO., Division St., Chelsea, Mass.



LEARN THE CODE AT HOME



WITH THE OMNIGRAPH

THE OMNIGRAPH Automatic Transmitter will teach you both the Wireless and Morse Codes—right in your own home—quickly, easily and inexpensively. Connected with Buzzer, Buzzer and Phone or to Sounder, it will send you unlimited messages at any speed, from 5 to 50 words a minute.

THE OMNIGRAPH is not an experiment. For more than 15 years, it has been sold all over the world with a money back guarantee. The OMNIGRAPH is used by several Depts. of the U.S. Govt.—in fact, the Dept. of Commerce uses the OMNIGRAPH to test all applicants applying for a Radio license. The OMNIGRAPH has been successfully adopted by the leading Universities, Colleges and Radio Schools.

Send for FREE Catalog. **DO IT TODAY.**
THE OMNIGRAPH MFG. CO., 15 HUDSON STREET, NEW YORK CITY
 If you own a Radio Phone set and don't know the code—you are missing most of the fun

which may be passed on to the loud speaker through the capacity coupling between the various windings of the power transformer. In the present case this trouble is eliminated by placing a copper shield between the primary and secondary windings. This shield is *not continuous*, but overlapped at the edges, electrical contact of the latter being prevented by a strip of insulating material laid between.

Another source of trouble was found in the pulling of the plugs from either jack, shown in Fig. 3, whereupon disagreeable noises emanated from the loud speaker. This has been prevented by using the short-circuiting jacks as shown in the diagram.

The operation of this combined "B" eliminator and power amplifier is very satisfactory and the apparatus has much to recommend it. In the near future there will be presented in RADIO NEWS a complete constructional article in which all the constants and other details of the system will be given.

Radio Wrinkles

(Continued from page 247)

bare copper wire; about No. 12 or 14, with a thick brass or copper strip interposed between the pipe and the wire. The wire should not be wound on too tight. After this job is completed a wooden or metal wedge should be fitted in between the metal strip and the pipe. A hammer will do the rest. The further the wedge is forced in the tighter will be the connection.

Contributed by Edmund Woodard.

New Developments In Radio Apparatus

(Continued from page 221)

calculations dead-end losses. It is claimed that in this coil such losses have been eliminated entirely.

The type of winding of the coil is a cross between the honeycomb and the Lorenz styles. The coil is tapped and the leads brought out to a rotary switch, seen at the left of the illustration. This switch is operated by turning the handle on the back of the coil; and the wave-length range, when the coil is shunted by a .0005- μ f. variable condenser, is from 160 meters to 4,300. This style of inductance should prove to be a very efficient one, as it will make the receiver in which it is installed tune very much sharper.

The mounting is the same as that used with the ordinary honeycomb coil; and the coils are encased in a thin bakelite shield, protecting the wire from atmospheric changes, accidents, etc. The casing is made thin in order that the whole outfit may be as light as possible, as the weight plays an important part when the coil is placed in a mounting that can be varied.

S. L. F. VARIABLE CONDENSER

- When condensers having a straight line in the graph for their dial-setting-frequency characteristic were first put on the market, the general cry that arose from the basement and attic set-builders was, "They take up more room on the panel than _____!" (Supply your own simile.) And this was true enough to a certain extent; for it will be remembered that the movable plates were eccentric, and therefore the space required seemed at first glance excessive.

However, the radio public has been convinced of the worth of straight-line-frequency condensers, and today there are hundreds of receivers on the market in which

Insure your copy reaching you each month. Subscribe to Radio News—\$2.50 a year. Experimenter Publishing Co., 53 Park Place, N. Y. C.

BUILD YOUR OWN RADIO SET!

FREE THIS VALUABLE 68-PAGE BOOK

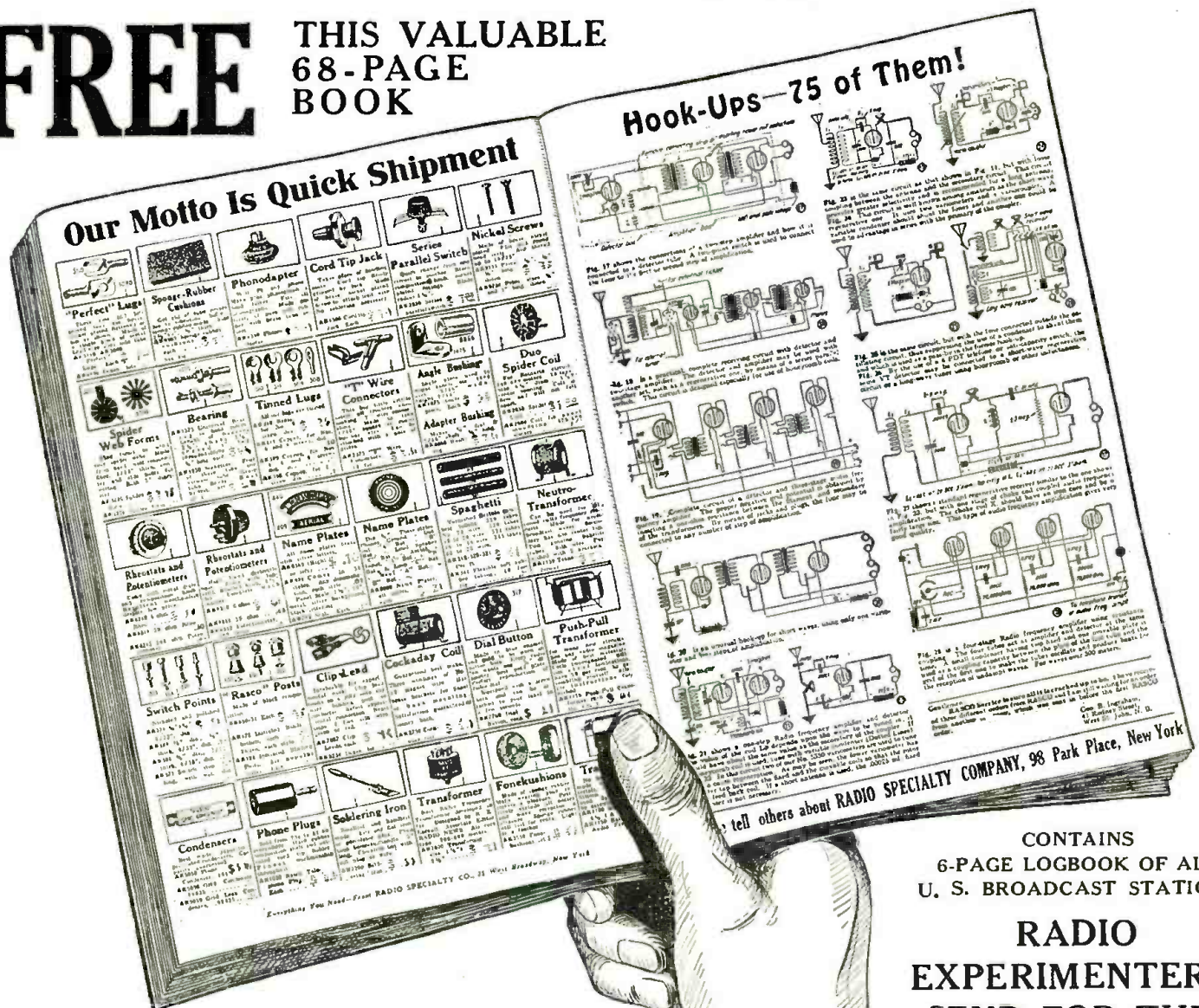

THE BIG 1926 SPRING CATALOGUE No. 16
68 Pages—600 Illustrations

Buy from Radio's Oldest Mail Order House

THE NEW RASCO CATALOG No. 16

Contains the Following Hookups.

All Armstrong Circuits: These important circuits are explained clearly, all values having been given. Just to name a few of the Vacuum Tube circuits: The V.T. as a detector and one-step amplifier; Super Regenerative; one-step radio frequency amplifier and detector; three-stage audio frequency amplifier; short wave regenerative circuits; 4-stage radio frequency amplifier; radio and audio frequency amplifier; inductively coupled amplifier; all Reflex Circuits.

This catalog is crammed full of small parts and radio findings. Literally thousands of them. In addition there is much useful information contained herein.

WE are the oldest established, exclusive radio mail order house in the country. Our motto is "Quick Shipment." All orders are shipped within 24 hours. Quick, prompt, courteous service. We carry a larger variety of radio parts and findings than any other radio house in the country.

"RASCO HAS IT"

If you are in need of certain small radio parts that other radio and mail order houses do not bother to carry, get the Rasco parts catalog, and you will find them there, anything from a screw to copper ribbon and telephone diaphragms, as well as thou-

sands of other small radio findings. Just to mention a few:

Lugs, nuts, dials, vernier dials, jacks, plugs, every kind of knob, cords, panels, screws, sliders, washers, selenium, tinfoil, switches, crystals, cap nuts, Litz wire, cord tips, brass rods, resistances, name plates, spring binding posts, switch parts, metal ribbon, carbon balls, binding posts, all types, switch points, switch levers, lock washers, carbon grains, ground clamps, metal pointers, insulated tubing, low melting metal, antenna connectors, bus bar wire, as well as thousands of others.

WE CARRY THE LARGEST VARIETY OF SMALL RADIO PARTS IN THE WORLD.

If you will paste this coupon on a post card and mail today, we will be pleased to send you our new Catalog at once.

RADIO SPECIALTY CO.

98 Park Place

New York City

CONTAINS 6-PAGE LOGBOOK OF ALL U. S. BROADCAST STATIONS

RADIO EXPERIMENTERS, SEND FOR THIS FREE BOOK TODAY

RADIO SPECIALTY CO., 98 Park Place, New York, N. Y. R. N. 9-26
 You may send me, without charge or obligation, your NEW CATALOG No. 16. (Write on margin if you desire).

Name

Street

P. O. State

Ferguson

SIMPLY select your program, turn up its wave-length and in comes your station! The calibrated-in-meters single tuning control turns the trick without guess-work, searching or adjusting.

An orchestra is playing. You hear each note from every instrument; the harmony of the whole rolls into your living-room with a "fullness" that marks a new standard in tone fidelity. You choose to dance. The jazz band is yours—even to the deep "boom" "boom" of the bass drum. The soft, silvery tones of the piano treble—each syllable of a woman lecturer—all are clear and true with the FERGUSON Model Ten.

Hear a comparative demonstration or write us today!

J. B. FERGUSON, INC.,
225 West 57th Street, New York, N. Y.



The FERGUSON Model Ten is a 6-tube receiver with two stages of highly sensitive tuned radio frequency and a three-stage resistance-coupled amplifier. Its marked selectivity is the result of complete shielding. Price, \$110. (Slightly higher west of the Rockies)



The Gold Standard of Radio Receivers

they are incorporated. Still the first outcry of the fans has been remembered, and the designing engineers have been endeavoring to produce a condenser of this type which will take up on the panel no more space than the ordinary condenser of the old S.L.C. type.

In the "phantom" or "X-ray" drawing accompanying this article is shown an S.L.F. condenser which, when the plates are separated as far as possible, takes up only 3 3/4 inches on the panel. Instead of having plates which are curved on one edge and straight on the other, this condenser employs rectangular plates. As may be seen from the drawing, a cam is attached to the dial on the front of the panel. This cam is held in place by two pegs that slide in grooves in the bakelite base of the condenser. In the two posts to which the plates are attached, are springs that hold the pegs running on the cam tight up against it. When the dial is rotated the cam throws these pegs to the outer edge and the plates mesh; when the cam is turned in the opposite direction the force of the springs is exerted and the plates spread apart.

However, the pressure of the springs is just enough to keep the pegs close against the cam, when the condenser is mounted in a horizontal position. (See top page 221).

Television An Accomplished Fact

(Continued from page 207)

roughly the methods used by Mr. Baird to achieve it, let us now turn to his actual accomplishments.

While in London recently, the writer was privileged to witness a demonstration of Mr. Baird's apparatus in working order. The great inventor was much interested to learn that readers of RADIO NEWS were anxious to learn something about his work; and readily acceded to the writer's request for a demonstration.

Leading the way to the transmitting room, Mr. Baird moved over several switches. Behind a light-proof partition, where were located the revolving discs and the light-sensitive cell, a motor could be heard to start up. In the center of the partition was the large collecting lens, around which were mounted a battery of powerful lights, screened from the lens by means of reflectors which concentrated the light upon the scene to be transmitted.

Next, Mr. Baird marshalled before me several members of his office force, and told me to take a good look at them so that I should be able to recognise them again. This done, Mr. Baird led the way downstairs to the receiving room on the next floor, and seated me before the "Televisor," as he calls his receiving apparatus. Before me was a wooden cabinet, in the middle of which was a screen. Mr. Baird threw over some switches, made some adjustments, and then switched out the light, leaving the room in total darkness except for a flickering sepia-colored light on the screen.

Picking up a microphone, Mr. Baird instructed one of his assistants to seat himself before the transmitter. The reply came back through a loud speaker, and immediately an image appeared upon the screen.

There was no mistaking it. It was the head and shoulders of one of the men I had just seen upstairs. True, the image was flickering somewhat, and looked rather out of focus. The best description I can give of it is to compare it with the earliest forms of cinematograph. Nevertheless, the image was there, in smooth gradations of light and shade, bright high lights, dark shadows, and

CARTER

"HI-OHM" Universal Volume Control

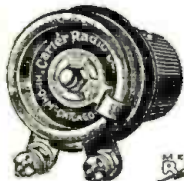

\$2

Half Size

Same size and general construction as famous Carter "100" Rheostat. All metal—no moulded parts to crack or break. Smooth, silent contact. Same in potentiometer form—CARTER "HI-POT" \$2.25.

Any dealer can supply

In Canada: Carter Radio Co., Limited, Toronto



Special Library of Information

on

RADIO PATENTS and TRADE MARKS

JOHN B. BRADY

Patent Lawyer

Ouray Building Washington, D. C.

Cable address: RADIOPAT

Telephone: Main 4806



MAKE MONEY SELLING CANDY FLOSS

at fairs, etc. Ask for pamphlet. Candy Machine Dept.



AUTOMATIC FISHPOD CO., 266 Langdon St., Toledo, O.



ALDEN MANUFACTURING COMPANY

Springfield, Mass.

Insure your copy reaching you each month. Subscribe to Radio News—\$2.50 a year. Experimenter Publishing Co., 53 Park Place, N. Y. C.

BOSCH NO BATTERY

The NOBATTERY



For a number of years the Bosch NoBattery has been considered the most satisfactory power unit for supplying "B" current. Now we present the New Edition 3 Bosch NoBattery improved in performance, simplicity, adaptability and appearance. Safe to use on any receiving set. Powerful enough for any set up to 10 tubes and with a broad range of capacity from 90 to 135 volts or better of "B" current.

Bosch NoBattery is precision built, entirely automatic, no AC hum, no chemical action noises, no filaments to burn, no acids to renew, no adding water. Mistake-proof, cannot burn out tubes. Gives unvarying full power to your set, keeping it at top efficiency to pull in weak and distant stations. Improves the volume and tonal quality of all reception. Just plug in and forget "B" current cares and all power supply troubles. Demonstrated at all Bosch Dealers.

ED-3 for Alternating Current \$55.00; For Direct Current \$42.00

The AMBOTONE

BOSCH
AMBO-
TONE \$27.50

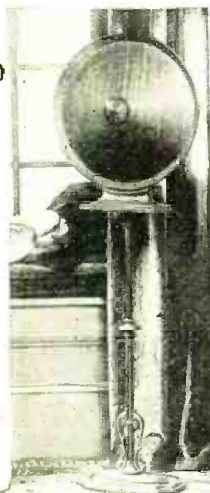

ART-
PEDESTAL
AT \$11.50

The wood cone reproducer that is unsurpassed for radio reproduction. The Bosch Ambotone is mellow in tone and absolutely accurate in reproduction over the full range of orchestral music and the human voice. Nothing is lost to the Ambotone—nothing blurred or distorted, not even the bass notes so commonly lost in radio reproduction. The Bosch Ambotone will give you the full value of your set. Beautiful in appearance it will improve your radio corner.

The Bosch Ambotone \$27.50—The Art Pedestal shown with the Ambotone is a separate item with a wide appeal to those who wish to improve the appearance of their radio. Its price is \$11.50

All prices slightly higher in Colorado and west and in Canada.

AMERICAN BOSCH MAGNETO CORPORATION
Main Office and Works: - - - - Springfield, Mass.
Branches: New York Chicago Detroit San Francisco

every one a micadon

There are now three types of Micadons—each made to meet a new development in radio.



MICADON 601

Micadon 601 is the standard of small fixed condensers. Designed on revolutionary principles, it was one of the first radio products to discard heavy molded insulation with its high dielectric losses. It provides and maintains a constant, fixed capacity wherever small condensers are required.

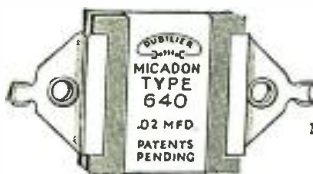

MICADON 640

In Micadon 640, the need for higher capacities in super-heterodyne, reflex and resistance-coupled amplifiers has been met. The same accuracy, the same principles of insulation and protection against losses in its fixed and permanent capacity have given this condenser its unequalled popular demand.



MICADON 700

Micadon 700 is the newest addition to this famous line. Completely shielded in its bright aluminum case, it is designed to withstand even the voltage found in low-power C. W. vacuum tube transmitters; thus providing the most compact, efficient and economical unit of fixed capacity that radio has yet known.

Three different types—but every one a Micadon. In the patented principles of their design; in the scrupulous care given to every stage of their manufacture; in their delicate precision, fully shielded and protected—worthy to bear the name of radio's greatest maker of condensers.

4377 Bronx Blvd., New York, N. Y.

Dubilier
CONDENSER AND RADIO CORPORATION

half tones, and perfectly recognizable beyond all question or doubt.

Mr. Baird then handed me the microphone and suggested that I should ask the sitter to perform various actions. I did so, and before my eyes the image moved, the eyes and mouth opened and closed, a hand rubbed the chin, and so on, exactly in accordance with my telephonic requests to the transmitting room.

As a final acid test, I requested the sitter to repeat certain words into the microphone at his end. He did so, and as these words issued from the loud speaker in the receiving room, I was able to follow distinctly the movements of the speaker's lips on the screen of the Televisor.

The other members of the staff whom I had seen came before the transmitter in turn, and I was able to recognize each one without difficulty.

TRANSMISSION PROBLEMS

During the above demonstration, transmission from the one room to the other was effected over a wire circuit, and Mr. Baird explained that the question of distance is an entirely minor problem of an ordinary telephonic character. Given any circuit, wire or wireless, however long, which will convey intelligible speech, Mr. Baird states that he can transmit television over it. He has already accomplished this by wire and radio over varying distances in England.

If the transmitted impulses are listened to, two sounds are heard. One is a low note, like that of a trombone, caused by the synchronizing current, and the other a high note, similar to a piccolo's, caused by the rapidly-interrupted picture impulses. Asked if these transmitted impulses could be made inaudible, so that one carrier wave could be utilized to convey the words of a speaker, in the usual broadcast fashion, and also television impulses which would render the speaker visible to his audience, Mr. Baird replied that this is perfectly feasible. To accomplish this would simply mean raising the frequency of the transmitted impulses to a frequency band above the audible limit. Mutual interference can, in such a case, be prevented by means of suitable filter circuits.

In actual fact, Mr. Baird has been aiming to do just this—utilize the carrier wave of a single broadcasting station to broadcast not only the usual programs, but also a continuously-animated picture of what is occurring in the studio at the transmitting station. In other words, just as we now hear what is happening before the microphone, Mr. Baird intends that we shall soon be able to see what is happening as well.

With this end in view, the inventor has devoted considerable thought to the simplification of the Televisor, or receiver. His aim has been to make it a piece of apparatus no more complicated than a loud speaker, which can be attached to the output terminals of an ordinary broadcast receiver, just as the loud speaker is, and in addition to it. This aim he has already achieved, and he is at present devoting all his energies to the further improvement of the transmitting apparatus which is progressing rapidly.

EFFECTS OF INTERFERENCE

In television, as at present demonstrated, the received image is liable to electrical distortion if not properly adjusted; and its effects are almost as distressing as distortion in a loud speaker, only that, instead of the music, it is the image which suffers. The image or face may appear flattened out as in a concave mirror, or a twisted effect may be produced, so that the face seen on the screen may have a flattened nose and a chin higher on one side than the other.

Fortunately distortion in the televisor is easily remedied, much more so than with a loud speaker. Adjustment is rendered easier as each effect can be seen, and the eye is a more reliable measuring instrument than the ear.



It Delivers
FULL "B" VOLTAGE

Burns

B-Battery Eliminator

Operates from lighting current like other household appliances. No hum or vibrations. Smooth constant plate supply. Once connected it requires no further attention or adjustment.

Popular Price—Write for Data.

American Electric Company

State and 64th Streets Chicago, U. S. A.
Makers of Burns Loud Speakers

22½
VOLT

unacid
everlasting
rechargeable

"B"

STORAGE
BATTERY

\$2.95

Includes
chemical



45 volts, \$5.25; 90 volts, \$10.00; 112½ volts, \$12.50; 135 volts, \$14.75; 157½ volts, \$18.80. Truly the biggest buy today. Easily charged on any current including 52 volt systems. Any special detector plate voltage had. Tested and approved by leading authorities such as Popular Radio laboratories. Over 3 years sold on a non-red tape 30-day trial offer with complete refund if not thoroughly satisfied. Further guaranteed 2 years. Knock-down kits at greater savings. Complete "Hawley" "B" Battery Charger \$2.75. Sample cell 35c. Order direct—send no money—simply pay the expressman cost on delivery. Or write for my free literature, testimonials and guarantee. Same day shipments.

B. HAWLEY SMITH

314 Washington Ave. Danbury, Conn.

FREE!— Radio Catalogue

Radio Parts of
the Best Quality

1. Right Prices
2. Quick Delivery
3. Dealer Cooperation
4. Complete Stock
5. National Advertising

CHICAGO
RADIO APPARATUS

415 South Dearborn Street, Chicago
Dept. RN

You can be quickly cured if you

STAMMER

Send 10 cents for 288-page book on Stammering and Stuttering. "Its Cause and Cure." It tells how I cured myself after stammering 20 yrs. B. H. Bogue, 6959 Bogue Bldg., 1147 N. III. St. Indianapolis.

Interference takes many shapes. The whoops and whistles, which frequently mar radio reception, appear on the television screen as small snowstorms—a mass of whirling white flakes passing across the screen—while interference caused by electric light mains appears as a series of white bands moving up and down across the image. Static appears in the form of sudden white flashes.

The interference troubles inflicted upon ordinary B.C.L.'s. are not nearly so distressing when seen. A white flash passing over a screen is not nearly so upsetting and jarring to the nerves as a piercing whistle or a crash of static in the midst of a musical selection.

COMMERCIAL EXPLOITATION

Mr. Baird has now formed a company called Television, Limited, for the purpose of exploiting his great invention; and rapid strides are daily being made towards the commercial application of his apparatus.

So many claims have been made from time to time that the problem of television has been solved, that perhaps the public and the scientific world are apt to look askance at any television claim. There is, however, a very big difference between a claim and a demonstration.

Mr. Baird has actually demonstrated the transmission by Television of an image of the living human face, with gradation of light and shade, all movements being faithfully portrayed. True, the results are far from perfect. This, however, is beside the point; which is that Mr. Baird has definitely and indisputably given a demonstration of real television in the presence, not only of the present writer, but also, on other occasions, to representatives of the British press; and it is the first time in history that this has been done in any part of the world.

Audio Amplification for the Beginner

(Continued from page 215)

nections, or those running from the "A" battery to the resistances, R and R1, may be bunched together. This new method is called "cabling the leads." The negative and positive wires, connecting the "B" battery to the instruments, can also be enclosed in the "A" battery cable.

If open transformers (that is, those not enclosed in a metal case), are employed, they should always be placed in the set so that their cores will be at right angles to each other. Placing them with the cores parallel may result in distortion and howling of the amplifier. On the other hand, when the transformers are enclosed in metal casings they can be placed very close together and, if absolutely necessary, with their cores parallel. It is, however, much better to place them with their cores at right angles, regardless of whether or not they have metal casings. It is usually preferable to connect either the cores of the transformers or the metal cases, depending upon the type used, to the ground wire of the radio receiving set. If the filament circuit of the present detector is grounded, it will be necessary only to connect the cores or the cases to the negative "A" battery wire. They will then automatically be grounded, when the amplifier is connected to the receiving set.

PRECAUTIONS

There are certain precautions to be taken in connection with the operation of an audio-frequency amplifier; and the most important of these pertains to the "overloading" of the circuit. By overloading is meant operating the instruments at voltages in excess of those for which the parts were designed,



Fool-Proof Power that ends all "A" battery troubles

For thousands of sets, Unipower is furnishing unfaltering "A" power, economically and constantly. The owners of these sets find themselves free from the worry and trouble caused by storage and dry battery operation.

Unipower is easily connected, easily controlled. It keeps the set always at full power at a minimum expense. The "trickle charge" embodied in Unipower is made fool proof by the addition of an emergency rapid charge rate, which is indispensable for continuous operation.

There is a Unipower for every set. And for large or heavily worked sets a regulator is provided to adjust the charge to the suitable rate.

Unipower, installed with a "B" power unit, provides a power operated set under one control. There is no unnecessary wiring—no parts to replace. We shall gladly send complete information.

Unipower operates from alternating current 110-125 volt—60 cycle. It contains a Balkite charging unit of special design.

6 volt—for 201A tubes
and equivalent \$42.50

4 volt—for 199 tubes
or equivalent \$33.00

(Special models, 25-50 cycle, at slightly higher prices)

GOULD STORAGE BATTERY COMPANY, Inc.
250 Park Avenue - - - New York City

Unipower

Trade Mark

A NEW WAY TO SELL RADIO CABINETS

Whoever Heard of Such a Thing Before?

We have placed on the market two NEW STYLES on which we give you choice of stock sizes at the same price. Our "Piedmont" is made of hardwood, fancy nicked hinges, three coats of the new lacquer varnish rubbed to a hard smooth glossy finish, mahogany finish only.

Sizes 7" x 18" x 10"; 7" x 21" x 10"; 7" x 24" x 10"; 7" x 26" x 10"—YOUR CHOICE AT ONLY \$2.65 EACH. Cash with order, no C. O. D., f. o. b. Hickory.

We challenge anyone to show us a cabinet of this fine quality selling at such a low price. We have been making cabinets for four years—a few cents profit on each one but a big production.

Send for Catalogue—Its FREE.

THE SOUTHERN TOY COMPANY, INC., - - HICKORY, NORTH CAROLINA
Dept. N.

SQUAB BOOK FREE
Breed squabs and make money. Sold by millions.
Write at once for free 40-page book beautifully
printed in colors telling how to do it. You
will be surprised. PLYMOUTH ROCK SQUAB CO.
156 H St., Melrose Highlands, Mass.

EVERYTHING IN RADIO
AT ATTRACTIVE PRICES
SETS OR PARTS
Mail order only
ALL RADIO COMPANY, 417 North Clark St., Chicago



A Chorus with no Bass Voices?

CAN you imagine that—a chorus without basses?

What would it sound like? What DOES it sound like?

Anyone with an ordinary radio set can tell you.

The Daven Bass Note Circuit, which is creating such a sensation among the fans, embodies everything that a good circuit should have—Quality—Volume—Sensitivity—Selectivity and Ease of Tuning. The Daven Super Amplifier, assures perfect reproduction; the DRF Coils, designed as a companion of the Daven Super Amplifier, functions as perfectly in the Radio end as the Super Amplifier does in the Audio.

Six tubes, tuned radio frequency, volume controlled from the faintest whisper to enough to blast the speaker.

Straight line construction, simple to build. Any Authorized Daven Service Dealer can supply you with all of the parts with full instructions.

For full information and address of nearest Daven Dealer, write us direct.

DAVEN

Bass Note Circuit

Embodying These Standard Daven Radio Parts

- 1 Set D. R. F. Coils
- 1 Daven Super-Amplifier with the New Glastors
- 3 Daven Mu-20 Tubes
- 1 Daven MU-6 Power Tubes
- 1 Daven Leakandenser No. 22
- 1 Daven 1/4 Ampere Ballast
- 1 Daven 1/2 Ampere Ballast
- 1 Daven Type "A" Condenser



Daven Super Amplifier, combines with any circuit, giving pure tone, free from distortion.

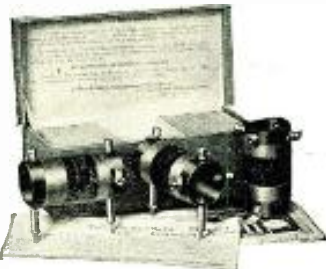

Daven Radio Frequency Coils combine extreme sensitivity with selectivity and ease of control.

RESISTOR MANUAL

This book 25c at dealers, describes Daven Resistance Coupled Amplification fully. 30c by mail.

Write for free Catalog



"The Sine of Music"
DAVEN RADIO CORPORATION
 Trade Mark Resistor Specialists Registered
 149 SUMMIT ST. - NEWARK, N. J.

or using certain parts in a manner for which they were not intended. The main mistake of the average amateur, when first operating an audio-frequency amplifier, is to advance the filament current and voltage beyond the capacity of the tube. Never try to get more volume out of an amplifier by advancing the rheostat beyond the point where the signals are at normal intensity and of good quality. "Overloading distortion" is bound to result, and the life of the tube is greatly reduced.

Vacuum-tube filaments are at their best very fragile, and any attempt to operate them at too high a voltage will increase their fragility and decrease the operating life. The best of transformers, instruments and lay-outs will not make a good amplifier, if an excessive voltage is applied to the plates of the tubes. Coupled with the warning not to overload the tubes, is the reminder also not to overload the loud speaker. If a speaker is not designed to handle great volume, do not attempt to make it do so by force. If you do this you may damage the speaker, but you will not get good results.

If your receiving set proper is of the single-tube regenerative type use less regeneration when an amplifier is added than when the detector alone is used. With the detector alone, a slight distortion in that particular circuit will not be noticeable on the headphones; but when the amplifier is connected, the distortion, as well as the signals, will be amplified. Reduce your regeneration control with the amplifier, and you will get the best reproduction.

The whole success of the operation of an audio-frequency amplifier rests in *moderation*. Extreme volume, unless desired for concert work, is an abomination. Why must some radio set operators work for enough volume from their set to be heard two blocks away, when volume to comfortably fill a medium-sized room is all that is necessary? When you want to listen to your own set only in the room in which it is located, reduce the volume by using slightly less plate voltage, or by employing only one amplifying tube instead of two. This is particularly true on local stations.

The amount of volume may also be cut down by reducing the regeneration control, and by doing this the signals will also be made much purer. Regardless of how the volume is cut down, it results in purer tones; and so, by operating your set with only as much volume as is necessary, you will desist from annoying your neighbor, and you will also be treating yourself to purer reproduction of voice and music. Use moderation in radio amplification, as in the other good things of life, and you will derive greater satisfaction from it in the end.

(NOTE: A series of articles by Sylvan Harris, explaining at more length the requirements for good audio-frequency amplification, and the characters of the amplifiers now in use, began in the June issue of RADIO NEWS, and will continue through several months. The treatment of the subject is simplified as far as its nature permits, in explaining the most recent discoveries in audio-amplification methods: and even the beginner in radio will derive much information and profit by reading these from the beginning.—EDITOR.)

A SCOTCH BROADWAY

"—They say it's impossible to tune out the local stations in Scotland."

"—How's that?"

"—The announcers speak with such a broad accent."

—Contributed by William G. Mortimer.



QUALITY **DONGAN** PRODUCTS

B-Power Unit

Undoubtedly this new Dongan B-Power Unit (1 transformer and 2 chokes) represents the highest point yet reached in the successful elimination of B Batteries.

Built in strict accordance with Dongan's exacting specifications, this compact, smooth-operating B-Power Unit assures efficient B-Power when built according to instructions.

In addition to this model Dongan builds various designs of both cased and uncased transformers and chokes for use with all types of Full and Half-Wave Rectifying Tubes.

Orders filled direct from factory if dealer cannot supply you.

Set Mfgs.—Complete information and prices upon request.

Special Transformers for Trickle Chargers.

New Models Audio Transformers for SET MANUFACTURERS

Dongan Electric Manufacturing Co.,
2977 Franklin St. - Detroit, Mich.



No. 1582 for Standard Raytheon Tube \$11.00 list.

TRANSFORMERS of MERIT for FIFTEEN YEARS



WRITTEN 2-YEAR GUARANTEE

Battery Prices SMASHED!

To Consumers Only

Here is a real battery quality, guaranteed to you at prices that will astound the entire battery-buying public. Order Direct From Factory. Put the Dealer's Profit in your own pocket. You actually save much more than half, and so that you can be convinced of true quality and performance, we give a *Written 2-Year Guarantee*. Here is your protection! No need to take a chance. Our battery is right—and the price is lowest ever made. Convince yourself. Read the prices!

Auto Batteries	Radio Batteries
6Volt. 11 Plate, \$8.50	6Volt. 100 Amp. \$8.50
6Volt. 13 Plate, \$10.25	6Volt. 120 Amp. \$10.25
12Volt. 7 Plate, \$11.75	6Volt. 140 Amp. \$11.75

Buy Direct—Send No Money

We ask no deposit. Simply send name and address and style wanted. Battery will be shipped same day we receive your order Express C.O.D. subject to your examination on arrival. Our guarantee accompanies each battery. We allow 5% discount for cash in full with order. You cannot lose! Send your order today—NOW!

ARROW BATTERY CO.
Dept. 8 1215 So. Wabash Ave., Chicago



MODEL 'B'

VARICK ELECTRIC SOLDERING IRON

\$1.25

Postpaid

Guaranteed for one year

Operates on either D.C. or A.C. 110 Volts. Nichrome heating element prevents overheating and assures even temperature. 5 ft. of cord and 2 pc. plug furnished. If dealer cannot supply you order direct.

JOBBERS—Write for discounts

Varick Elec. Mfg. Co., 324 W. 42d St., N. Y.

Write for Booklet

AMSCO PRODUCTS Inc.
Broome and Lafayette Sts.
New York City

NEW QRA'S

5 ANI, Frank Watts, 1716 Park Ave., Shreveport, La. 20, 40, 80 meters, 5 watts; all cards qsl'd.

5ADI, Thomas Sale, 1342 Orange St., Abilene, Tex. 40, 80, 175 meters, 5 watts; all cards qsl'd immediately.

9ARN, John S. Roelfs, Jr., Bartonville, Ill. 7½ watts cw., 40 meters. Will appreciate reports on sigs and qsl all.

Book Reviews

RADIO FREQUENCY MEASUREMENTS, by E. B. Moullin; London, Charles Griffin and Company, Ltd.; Philadelphia, J. B. Lippincott Co. 6¼x9 inches, illustrated, 278 pp., cloth cover.

This book is an excellent text for those interested primarily in radio-frequency measurements, giving in detail description of the best accepted methods, together with discussions as to the accuracy to be expected of these methods. There are nine chapters dealing with the following subjects:

The Valve (Tube) Generator; Measurement of Potential Difference and Current; Measurement of Frequency; Measurement of Resistance; Measurement of Capacity; Measurement of Inductance; Measurement of Antenna Characteristics; Measurement of Intensity of Radiated Fields; Miscellaneous Measurements and Notes.

This book fills a long-felt want in radio engineering, having between its covers much material that has been previously available only through considerable research in periodical scientific literature.

RADIO ENGINEERING, by J. H. Reyster, B.Sc (Hons.), A.C.G.I.; London, Radio Press, Ltd. Bush House, Strand, W.C.2. 5¼x7½ inches, illustrated, 258 pp. with appendix of 195 pp.

This excellent book approaches the principles of radio from the standpoint of design, giving the accepted design formulae, with profuse tables and charts. It is divided into two sections, the first devoted to Radio Engineering. In this there are seven chapters dealing with the following



SM

The **why of S-M Audios**

S-M audio transformers were introduced with the guarantee that they would give the finest quality of reproduction obtainable. So far they have met with overwhelming success. Production has been steadily increased since the first samples brought back enthusiastic reports from editors, jobbers, dealers, and experimenters. **WHY?**

There must be reasons—facts behind this landslide of approval of transformers introducing an entirely new thought in audio reproducing systems.

These facts, briefly, are presented here. "The Secret of Quality" available at your dealer gives the substantiating details.

FACTS

FREQUENCY RESPONSE CHARACTERISTIC. The curve of the S-M 220 is flatter than that of any other commercial transformer from 32 to 1,000 cycles. Above 1,000 cycles the response falls off at a carefully pre-determined rate to compensate for the reverse effect in broadcast transmission and commercial loud speakers.

FREQUENCY RANGE COVERED. S-M 220's cover a range of from below 30 cycles to 8,000 cycles approximately. This allows reproduction of all common musical notes and their second harmonics—necessary for natural quality. Frequencies above 8,000 cycles are intentionally cut out thus eliminating hiss, background noise and high frequency oscillation.

NEW PRINCIPLE. S-M 220's are the first audio amplifying devices available to listeners in which the far-from-perfect quality of broadcast transmission and available loud speakers has been taken into account and compensated for. These two factors produce a signal weak on low frequencies and strong on high frequencies. S-M 220's do just the opposite. They possess a falling frequency characteristic—weak on high notes and strong on low notes. This compensates for everyday transmission and loud speaker characteristics of a reverse nature. The result is quality of unbelievable perfection.

PHYSICAL CHARACTERISTICS.—The weight of the 220 core, of highest grade Silicon steel, is over 2¼ lbs. The total weight is 4 lbs. Compare this against an average weight of less than 2 lbs. for five transformers supposedly in the class of the S-M 220 yet selling at from \$2.00 to \$4.00 each higher. The mean-turn length on the 220 wind-

ing is twice as great as several of the transformers referred to. This takes wire—plenty of it. The core cross-section is 1¼ inches.

All this means but one thing—quality—for assuming good average engineering, the quality of an audio transformer is almost always approximately proportional to its size.

HANDLING CAPACITY. The 220's will handle sufficient input energy to obtain maximum power output from a UX171 tube—over six-tenths of a watt. Properly operated they will develop an output voltage of from twenty to thirty volts—with an even flatter characteristic than shown in the curve. The primary windings will handle 15 milliamperes continuously.

OUTPUT TRANSFORMER. S-M 221 output transformer is designed to deliver maximum power to standard cone speakers at 30 cycles, and decreasing power as the frequency increases. This effect aids in compensating for average speaker characteristics of a reverse nature. S-M 221's will handle the full power output of a UX171 or UX210 tube. They are guaranteed to improve low note reproduction and handling power on any standard receiver when merely connected between the set and loud speaker.

GENERAL DATA. S-M 220's have a turn ratio of 3:1. Their primary inductance is approximately 100 henries. Their impedance ratio will fit any standard tube on the American market. The 220's and 221's are supplied in drawn steel cases, completely shielded. Guaranteed unconditionally against mechanical and electrical defects—and for absolute satisfaction.

"THE SECRET OF QUALITY" This booklet contains laboratory data never before available even to many manufacturers. It is the only authoritative treatise on all types of audio amplification, written in non-technical language, ever published. 10c is the price of this 96 page book. Ask your dealer for a copy.

SILVER-MARSHALL, INC., 848 W. Jackson Blvd., Chicago, U. S. A.

CRYSTAL CLEAR TONES ON ANY SET

Carborundum Detector



Stabilizing Unit

THERE is no denying the pure true quality of crystal reception.

And you can get such reception on any set without the fuss and worry of a nervous Cat's whisker jumping off the sensitive spot.

The Carborundum Stabilizing Detector Unit has revolutionized crystal detection. It is built around the Fixed Permanent Carborundum Detector—no Cat's whisker—no adjustments—retains its sensitivity and simply can not burn out.

The Stabilizer gives you a resistance controlling feature through which the Detector can be made to match the

impedance of any circuit. Simply turn the potentiometer knob.

The addition of an ordinary flash light dry cell gives the necessary booster voltage.

For greater sensitivity—greater distance—but above all for the reception of tones of natural quality equip your set with **The Carborundum Stabilizing Detector Unit**—it improves any set.

IN U. S. A.
\$3.50

Dealers or Direct

The Carborundum Company
Niagara Falls, N. Y.

Please send free Hook-Up Book D-1.

THE CARBORUNDUM COMPANY, NIAGARA FALLS, N. Y.

SALES OFFICES AND WAREHOUSES IN

New York, Chicago, Boston, Philadelphia, Cleveland, Detroit, Cincinnati, Pittsburgh, Milwaukee, Grand Rapids

Carborundum is the Registered Trade Name used by The Carborundum Company for Silicon Carbide. This Trade Mark is the exclusive property of The Carborundum Company.

Name _____
Street _____
City _____
State _____

YAXLEY

APPROVED RADIO R. DUOTS

Cable Connector Plug



One of the most practical accessories to a radio outfit. Simplifies the battery wiring and makes sure of an instant and correct battery connection any place the radio set may be moved to. Banishes the old-fashioned unsightly mass of battery wires.

Bakelite construction, neat and handsome in appearance. Metal cable markers and a colored template (RMA standard color code) on the connector plate make it easy to attach to any set. The Plug has phosphor bronze double contact springs, mounted in Bakelite, which cannot work loose. Shorting is impossible.

The Connector Plate has brass contact pins, tinned for soldering and is mounted upon a bracket which is reversible or may be entirely removed for subpanel mounting.

The Cable is of extra good quality, in seven strands. (RMA standard colors), and is five feet in length. Six extra markers packed with each plug.

No. 660 Cable Connector Plug, complete \$3.50

YAXLEY MFG. CO.
Dept. N
9 South Clinton St.
Chicago

subjects: Radio Calculations and Measurements; Tuning and Radiation; Thermionic Valves; Radio Transmitters; Radio Receiving Apparatus; Design of Masts and Aerials; Miscellaneous.

The second section of the book deals with Telegraphy and Telephony. In this there are two chapters, on the following subjects: Telegraphy; Telephony, as well as chapters under the following headings: Appendix A: Mathematical and Miscellaneous Tables; Electrical, Mechanical and Physical Tables, etc.; Electricity and Magnetism; Appendix B: Wiring Rules, Regulations, etc.

The Detectorium

(Continued from page 237)

The better way is shown in Figs. 2 and 3. The slider in this case may be a piece of wood with a square-filed hole. Contact is made with the slider rod by means of a small spiral spring, which presses against the metal screw, inserted in the lower end of the slider. The brass extension carries the adjusting screw B, which serves to vary the tension of the lower leaf spring, which carries the detector cup A. C represents the wire convolutions, D the second slider rod.

The detector cup A is a metal cup, in which the detector crystal is held by means of a fusible alloy. The part of the crystal making contact with the wire should not be sharp, but rounded off. If it is sharp it will scratch the wire and stick between the convolutions.

SIMPLE, SHARP, SATISFACTORY

If the Detectorium is constructed with care, a great amount of satisfaction can be had from it; because it places the detector right underneath one's finger, and tuning is done very rapidly. Particularly with silicon and iron pyrites, the tension adjustment is not very critical, and a little more or less pressure does not seem to make much difference, as reception is usually excellent in all cases.

The Detectorium is a most efficient instrument, because it does away with a number of extra parts and extra wires; and is therefore really a low-loss detector instrument. If carefully adjusted, it will be found that the Detectorium will surpass in loudness of reception almost any other crystal combination. Not only that, but *exceedingly sharp tuning can be done*, much sharper than you are accustomed to obtain with the usual crystal-detector arrangement.

The circuit diagrams, Figs. B and D, are excellent for sharp tuning; no value is given for the variable condensers, as this depends a great deal upon the construction of the Detectorium. .0005- μ f. condensers, however, are satisfactory in nearly all cases.

In Figs. 2 and 3 the detector-bearing cup is shown soldered right to the lower leaf spring. If desired, the lower leaf spring may be slotted, and by means of a screw arrangement, different crystals screwed in or out if different sensitivities are desired. It is understood that the Detectorium uses no batteries of any kind, as the rectified current of the incoming wave is sufficient to operate the telephone receivers.

I shall be glad to hear from those who have constructed the Detectorium.

SHE NEEDS A BRAKE!

A lady listener who found it difficult to keep pace with the tunes played by the dance bands, in desperation sought advice from the editor of a wireless publication. "Will you please tell me how I can slow down the music for dancing?" she inquired. "I have tried turning all the knobs, but it is no use."

—"News of the World," London.



Easy to Solder This New Way

Indispensable for all soldering work. Simple — Speedy — Economical

\$3.75
COMPLETE

Press-to-Feed Electric Soldering Iron

One hand does the work of two. Speeds up radio set construction. Far better than a blow torch. Solder will not melt until it reaches soldering point. Porcelain insulation prevents heat from entering handle.

AGENTS—DEALERS—JOBBER

This newly invented electric soldering iron offers big money making opportunity. Order a sample today \$3.75. Discounts in quantities on request. Write to.

ILLINOIS STAMPING & MFG. CO.
220 N. Jefferson St., Dept. 10, Chicago



SEE THAT SCREW

A Screw-Driver adjusts an X-L in crowded places

X-L VARIO DENSER

Results in easier tuning, more distance, volume and clarity—greater stability. Indorsed by leading radio authorities.

MODEL "N"—A slight turn obtains correct tube oscillation on all tuned radio frequency circuits: Neutrodyne, Roberts two tube, Browning-Drake, McMurdo Silver's Knockout, etc. Capacity range 1.8 to 20 micro-micro farads. PRICE \$1.00

MODEL "G"—with grid clips obtains the proper grid capacity on Cockaday circuits, filter and intermediate frequency tuning in heterodyne and positive grid bias in all sets. Capacity range: Model G-1 .00002 to .0001 MFD. Model G-5 .0001 to .0005 MFD. Model G-10 .0003 to .001 MFD. PRICE \$1.50

X-L PUSH POST—Push it down with your thumb. Insert wire, remove pressure and wire is firmly held. Releases instantly. PRICE 15c

X-L RADIO LABORATORIES
2425 Lincoln Ave. Chicago, Ill.

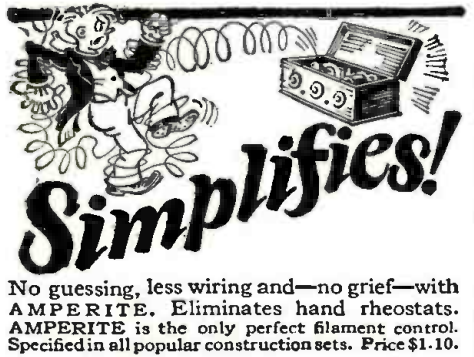

Simplifies!

No guessing, less wiring and—no grief—with AMPERITE. Eliminates hand rheostats. AMPERITE is the only perfect filament control. Specified in all popular construction sets. Price \$1.10.

Radiall Company
Dept. R.N.-9, 50 Franklin Street, New York City

Write for FREE Hook-ups

AMPERITE

REG. U.S. PAT. OFF.

The "SELF-ADJUSTING" Rheostat

SENT ANYWHERE ON 10 DAYS FREE TRIAL

5 TUBE RADIO

GUARANTEED

Get Special Offer

FACTORY PRICES—SAVE 1/3 TO 1/2. Smaller Sets \$13.75 up, retail. FREE! Literature on latest 1 to 5 tube models. Agents' new low prices and Dealers' SPECIAL OFFER! Write! MIDWEST RADIO CORPORATION, Pioneer Builders of Sets, 624-2 E. 8th St., Cincinnati, Ohio

BIG POWERFUL **MIRACO Ultra**

Users everywhere report it gets programs coast to coast, Canada to Gulf, loud and clear on speakers; outperforms \$100 to \$200 sets. Many hear Europe. Mar. 29 \$59.50. Retail continues you.

MIRACO RADIO GETS 'EM COAST TO COAST

RADIO DEALERS

WRITE today for your free copy of Albin's LATEST Radio Money-Saver Catalog. More complete than ever. Every page crammed with latest in sets, speakers, kits, parts and accessories. Fast moving items—unstable values—complete stocks—unqualified guarantee—SAME-DAY SERVICE. Buy from Albin and make this the BIGGEST YEAR you ever had.

THE ALBIN RADIO CO. INC.
221A FOURTH AVE., NEW YORK

Radio Jingles

WE reproduce herewith, through the courtesy of the *Saturday Evening Post*, some illustrated radio verses. The idea is sure to be obvious to all our readers. We know that the readers of RADIO NEWS can easily do as well as Mr. Jones, and with their radio knowledge, perhaps better.

Accordingly, RADIO NEWS will pay \$1.00 for every 4- or 5-line stanza accepted and printed here. Send all contributions to Editor, Radio Jingles, in care of RADIO NEWS.

A RADIO ROMANCE

*Heterodyne Smith, sorely wanting
a mate,
Resolved to go forth and select
her;
But knowing he needed a sparkler
for bait,
Bought a two-carat*



*When he met Sally Brown, it was
love at first sight;
Her hair was the color of henna;
She answered: "I'm ready to hook
up all right,
If you get the consent of*



*But our hero soon found out con-
clusively, that
From Auntie he'd get no assist-
ance;
For when he approached her she
gave him his hat,
And a cold look of*



*That night while the moon shone
like pure liquid amber,
'Neath Sal's window he stole,
without sound;
With the aid of a rope, she was
able to clamber
In safety, down to the*



*They married and moved to an ele-
gant flat,
Where their heartbeats grow
fonder and warmer;
And Het never kicks when she
wants a new hat,
For love's such a wondrous*



—Thomas R. Jones.

HINT TO HAMS

*Said a young would-be ham they call Mac,
"The price for an outfit I lack:"
With a Wrinkle he tries—
It wins the first prize—
And he'll fit up his shack with the "*



—By Joseph Riley.

A TRANSFORMER

"Is there any mention of radio in the Bible?"—"Yes. A spare part of man was taken, and out of it was made a loud speaker."

—"News of the World," London.

WITT "GROSS" APOLOGIES

Nize baby, ett opp de schwiback milk dunk und momma gonna tell ferry sturry witt squeels witt howls like degenerate recewer.

SILITE TRICKLE CHARGER

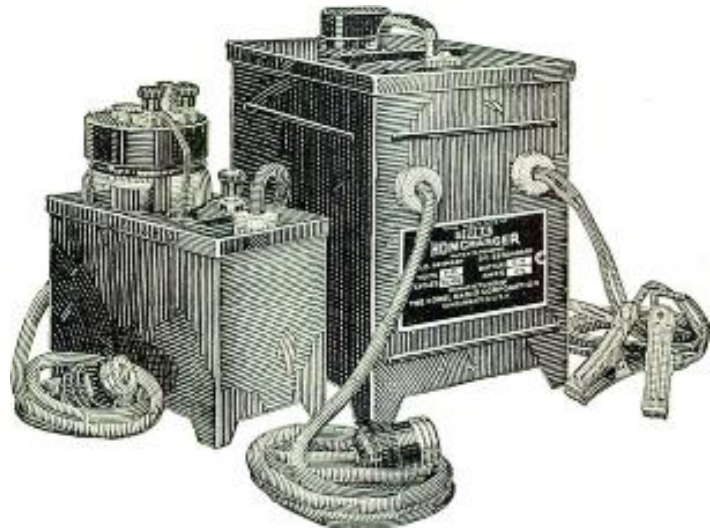

Absolutely Noiseless— Makes a power unit of your storage battery!

You can make a power unit of your present storage battery with the new Silite Trickle Charger.

Absolutely noiseless, without bulbs or moving parts, Silite Trickle Charger is left permanently on charge. It replaces at a slow rate the power you use while your set is operating. Silite Trickle Charger may even be used while your set is in operation without hindering enjoyable reception.

No Bulbs—No Adjustments—Can't Wear Out!

Silite is the marvelous new metallic glass rectifying element discovered and perfected in the Kodol Laboratories. Silite Chargers have no adjustments, no wearing parts—they cannot overheat or damage your battery. Silite Trickle charges at .6 ampere—much faster than other trickle chargers—enough to keep a battery always at top efficiency. Your nearest radio dealer can show you the Silite Trickle Charger.

SILITE HOMCHARGER

Absolutely silent—fast 2½-3 ampere charging rate. No bulbs. Can be used while set is in operation. Complete, nothing else to buy . . . \$19.50

SILITE TRICKLE CHARGER

Makes a power unit of your battery. Left permanently on charge keeps a battery always at full efficiency. Absolutely silent—no bulbs. Complete . . . \$10.00

["Behind the Scenes in a Broadcasting Station", an interesting, 24-page booklet, together with literature describing Silite Battery Chargers, will be mailed free on request.]

DEALERS: Write for full information on Silite Chargers and other Kodol Products.

THE KODEL RADIO CORPORATION, 501-521 EAST PEARL ST.
CINCINNATI, O., U. S. A.
Owners and Operators of Broadcasting Station WKRC

Battery Chargers Power Units **KODEL** Radio Receivers Loud Speakers
POWER SPECIALISTS SINCE 1912

Overloading the Audio Amplifier

(Continued from page 244)

microfarads (80 $\mu\text{f.}$) and in some cases higher. We will consider later on the particular values which apply to the different types of amplifiers.

EFFECT OF FREQUENCIES

It has been mentioned before that the input of the tube can be regarded as a condenser in series with a resistance. Expressions for the resistance are also given by Miller; but a few brief calculations will show that this resistance is small compared with the reactance due to the capacity, so we will neglect it. The input impedance of the tube is therefore the reactance of the input capacity, and this is shown in Fig. 4 for several different resistances in the plate circuit. The range of frequencies covered by this curve is the audible range, for we are considering audio amplifiers.

The curves of Fig. 4 show plainly that, for frequencies higher than above 2,000 cycles per second, the input impedance of the tube may be less than one megohm, and for frequencies even higher than this, or for large-load resistances, may be as low or lower than a half a megohm. It is evident, therefore, that we have no right to assume that the transformer or other coupling device works into an open circuit; for since the input impedance of the tube is not infinite, but in some cases relatively low,

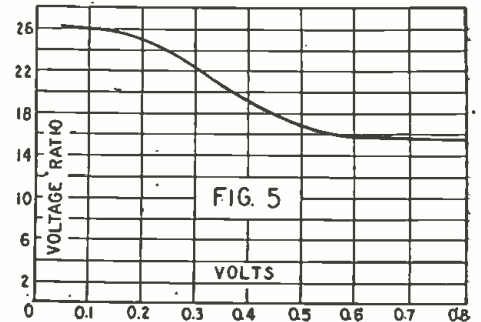

Showing the change in a tube-transformer amplifier's voltage ratio at a constant frequency. Note how the ratio falls off as the input increases.

it may present an appreciable load on the coupling device.

The effect of this load on the operation of the transformer, impedance or other coupling device may also be quite appreciable, in that it may effect the voltage regulation. By the term "voltage regulation" we mean the drop in secondary voltage that occurs, at a given frequency and for a given voltage input to the coupling device, when a load is placed on the output. In other words, suppose we have a certain voltage impressed at a certain frequency on the primary of a transformer. When there is no load on the secondary, that is, when the secondary is working into an open circuit, there will be a certain voltage across the secondary terminals. If, now, a load is applied to the secondary the voltage at the terminals of the latter will drop. The percentage drop in voltage is the voltage regulation. The same idea applies to any type of coupling device if we replace the word primary by the word "input" and the word secondary by the word "output."

OVERLOADING THE GRID

Another serious effect occurring in amplifiers is overloading the grid. Suppose the path from the grid to the filament outside the tube has a very high resistance; as, for instance, in the case of a resistance-capacity-coupled amplifier in which the grid-leak re-



So easy...
plug in
... battery charging



Plug in the Tungar. Turn a switch to the right—and your "A" batteries are charged. To the left for your "B" batteries. Yes, it's as simple as that—with a Tungar.

Tungar is the original bulb charger. It is a G-E product developed in the Research Laboratories of General Electric.

It charges 2.4 and 6 volt "A" batteries, 24 to 96 volt "B" batteries, in series; and auto batteries, too. No extra attachments needed

It causes no radio interference.

It will not blow out Radiotrons

East of Rockies

Two ampere size \$18.00

Five ampere size \$28.00

60 cycles . . 110 volts

Merchandise Department
General Electric Company
Bridgeport, Connecticut

An easy installation connects your Tungar permanently. Then you can conceal batteries in a cabinet, or down cellar—and just have a convenient switch to close when you sign off for the night,

In the morning your batteries are at their best, and you've only used about a dime's worth of current.

Tungar

REG. U.S. PAT. OFF.

BATTERY CHARGER

Tungar—a registered trademark—is found only on the genuine. Look for it on the name plate.

GENERAL ELECTRIC

ATWATER KENT RADIO

1926 FREE RADIO GUIDE

NEWEST 1926 EDITION

Shows the latest circuits, the newest developments in radio at startlingly low prices. Get the parts you want here and save money. The best in parts, kits, sets and supplies. Orders filled same day received. Write for free copy NOW; also please send names of one or more radio frns.
BARAWIK CO., 102-145 So. Canal St., Chicago, U. S. A.

MARKO

RADIO BATTERIES

are

ALWAYS DEPENDABLE

MARKO STORAGE BATTERY CO.
Brooklyn, New York

COIL WINDINGS

Audio-B Eliminator—Bell Ringing Trans.

TELEPHONE RINGER—CHOKE—

IGNITION—CONTROLLER & SPECIAL

SOLENOID WINDINGS

Easton Coil Co. P. O. Box 237
Easton, Pa.

Insure your copy reaching you each month. Subscribe to Radio News—\$2.50 a year
Experimenter Publishing Co., 53 Park Place, N. Y. C.

sistance is too high. As everyone knows, the grid will collect electrons, since it is in the path of the electrons flowing from the filament to the plate. The accumulation of electrons on the grid, when the leak-resistance is very high, may cause the grid to assume a relatively high potential. When this potential becomes sufficiently high the charge on the grid will leak off through the leak resistance, and we will have periodic charges and discharges of the grid, giving rise to the effect we often notice when we have an "open grid."

The number of these discharges per second, that is, their frequency, depends on the constants of the circuit, and may be anything, from a very low frequency producing a click, to an inaudibly-high frequency. Whether the click is audible or inaudible, it will have its effect on the quality of reproduction; for the clicks of inaudible frequency may combine with, or modulate, the voltages of audible frequency which we wish to amplify.

To illustrate the effect we are discussing, the voltage ratio of a well-known transformer working with a tube was measured at a constant frequency under varying impressed voltages. The results of the meas-

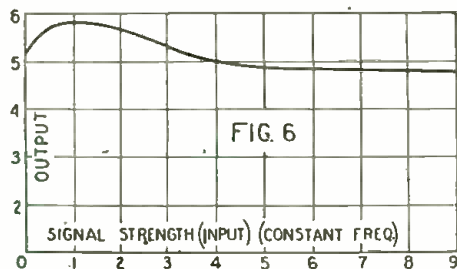

The effect of overloading on the output of an amplifier; it actually diminishes as the signal strength increases.

urements are shown in Fig. 5. The horizontal scale represents the input voltage and the vertical scale represents the ratio of the output to the input voltage; or, in other words, the voltage ratio of the combination of tube and transformer. It will be noted that the voltage ratio of the combination does not remain constant for different impressed voltages, as it should for ideal operation. Furthermore, notice that it drops off at about 0.2-volt input.

OPERATION OF LOUD SPEAKERS

This raises some interesting questions as to the voltages required to operate loud speakers. If we take a transformer having a ratio of 3 to 1 and a tube having an amplification constant of 7, the total voltage ratio of the combination will be 3×7 or 21; and this multiplied by 0.2 volt gives about 4 volts as the maximum to be impressed on the loud speaker, without overloading this particular transformer.

To test the effect of this voltage on the volume output of the loud speaker, a potential of 4 volts at the output of an audio-frequency oscillator was impressed directly upon various loud speakers at various frequencies. In some cases great volume resulted; in other cases not so much; depending upon the particular loud speaker used. The test indicated, however, that to operate good loud speakers much lower voltages are required than ordinarily imagined.

In Fig. 6 we have shown the overloading effect on a resistance-capacity-coupled amplifier, the curve of which was obtained in a different manner. A radio-frequency oscillator, modulated by a 1,000-cycle tuning fork, was set at various distances from a non-regenerative receiver employing a detector tube and three stages of resistance-coupled amplification. The frequency of the oscillator was kept constant. Connected to the output of the amplifier was an indicating device. In arbitrary units, therefore, the

A·B & C Light Socket Radio Power



for any set • new or old

Now all radio power is in your light socket. Kodol A and B Transifiers replace all batteries—just plug in the wall socket and smooth uniform A, B, and C current flows to your receiver—gives new pep, new life to any set—longer range, greater volume—reception such as was never possible even with fresh new batteries.

Kodol A & B Transifiers

Are vastly different and superior to so-called power units. Transifiers consume current only while you operate the set—much lower maintenance cost—less than one-half cent per hour to operate both A and B Transifiers. You may purchase both A and B or either model separately from your radio dealer.

<p>MODEL 10 "A" TRANSIFIER</p> <p>Supplies constant 2, 4, or 6 volts "A" power to sets using up to 10 tubes. Absolutely no hum, noise or interference.</p> <p>Price without bulb \$42.50</p>	<p>MODEL 61 "B" TRANSIFIER</p> <p>Smooth, powerful, noiseless "B" current for sets up to 6 tubes. 2½ to 90 volts.</p> <p>Price without bulb \$28.50</p>	<p>MODEL 10 "B" TRANSIFIER</p> <p>2½ to 150 volts "B" power, 4 to 10 volts "C" power. Constant uniform current to supply any size set. Will operate power tubes.</p> <p>Price without bulb \$42.50</p>
---	--	---

["Behind the Scenes in a Broadcasting Station", an interesting, 24-page booklet, together with literature describing Kodol A and B Transifiers, will be mailed free on request.]

DEALERS: Write for particulars on Kodol Radio power devices.

THE KODEL RADIO CORPORATION, 501-521 EAST PEARL ST. CINCINNATI, O., U. S. A.
Owners and Operators of Broadcasting Station WKRC

Battery Chargers Power Units **KODEL** Radio Receivers Loud Speakers
POWER SPECIALISTS SINCE 1912

“THE HEART OF THE RADIO”

VELVETONE
THE HEART OF THE RADIO

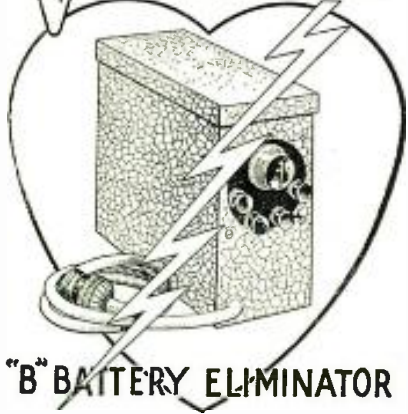

“B” BATTERY ELIMINATOR

Operates on either 50 or 60 cycles
110 A.C. Lighting Circuits

Improved Filtering Circuit (Pat. ap'ld for)
Absolutely eliminates A.C. Hum or Distortion

Positive Guarantee Against Mechanical or Electrical Defects

Velvetone Junior
90 Volt Outfit
\$24.75

Velvetone Senior
135-150 Volt Output
\$39.75

DISTRIBUTORS WRITE

Write Direct and Give Us The Name of Your Dealer

VELVETONE RADIO CORPORATION

3731 SO. PARK AVE.

of AMERICA

LOS ANGELES

“THE HEART OF THE RADIO”

Quickly demonstrate your sets in apartments, houses, hotels, offices, hospitals, etc.



Campers, tourists, resorters, fishermen, pluckers! Just what you are looking for!

**REEL OUT the Aerial---
PULL IN the Programs---
REEL IN when Through!**

No more hours wasted putting up or taking down antennas. No lead-ins to solder. No holes to drill. No tangling of wire. Carry a 21-ounce REEL AERIAL in pocket and put up a 100% efficient aerial in a few moments—any time, any place—outdoors, indoors. Its hard drawn FLAT copper wire (1/4-in. wide) can be led in under or over window or door which can be closed tight without harm to wire. Aerial can be reeled out or in to any desired length up to 100 ft. Unused portion in case does not cause dead-end losses. Place case on or near set and connect with cord which plugs into center of Reel Aerial. Order today. Satisfaction Guaranteed. DEALERS, JOBBERS! Write for attractive literature and proposition. Use Reel Aerials in making free trial demonstrations. Sell Reel Aerials to people going away on vacations, to experimenters, etc.

Fasten long cord with weight on it to insulator on REEL AERIAL. Throw weight over limb of tree. Reel out as long an aerial as you wish and attach to set with cord which plugs into center of REEL AERIAL.



For indoor aeri-als—can be put up around walls or reeled out on floor.

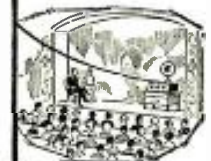

For use in halls, theatres, laboratories, schools, clubs, on trains, at fairs, etc.

SEND NO MONEY, JUST MAIL COUPON

HAWKEYE RADIO CO. Division of Hawkeye Lightning Rod Co., Dept. 1409, Cedar Rapids, Iowa.
Ship me—on your **MONEY BACK GUARANTEE**—one Reel Aerial C.O.D. I will pay postman \$5 plus few cents postage (postage prepaid when money accompanies order).

NAME
ADDRESS

You are dealing with an old reliable firm. **SEND THE COUPON NOW!**



Illustration is 1/2 size. Reel Aerial weighs only 21 oz. Nickel case, 4 1/4 in. dia. fits pocket. Contains 100 ft. 1/4-in. flat copper wire—best antenna known.

horizontal scale of Fig. 6 represents the distance between the oscillator and the receiver (or the signal strength) and the vertical scale represents the output of the amplifier. It will be noted that, after a certain maximum signal strength has been attained, the output of the amplifier not only ceases to increase as the oscillator is brought closer to the receiver, but is actually diminished, due to the overloading.

The effect of such overloading is evident. If we are listening to a concert and amplifying up to the point of overloading, the shading of the music will be lost. Piano and Forte will mean nothing; strong fundamentals will be amplified less than the weaker overtones; the timbre will not be true, and the interpretation of the artists will be lost.

A Plug-in-Coil Short-Wave Receiver

(Continued from page 245)

of tickler turns to about one-half. For the 80-meter band, about 13 to 15 turns will be required on the secondary. The primary and tickler may be the same as those used for the 40-meter band. In any event experimenting with the operation of the set will quickly aid in determining the correct constants.

The method used in winding the self-supporting coil shown was to provide a form slotted at right angles to the edge and then wind the heavy insulated wire thereon. Strips of celluloid, notched with a three-cornered file, were then held against the wire by placing them in the slots in the form, and cemented in place with a little collodion. After this material has dried,

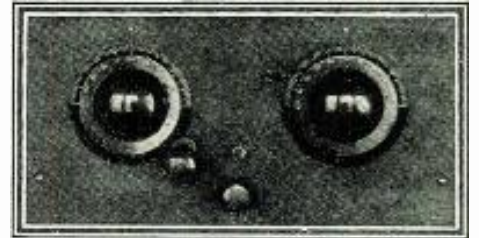

Front view of the short-wave receiver. The left dial is the tuning control and the right dial the oscillation control.

the coil will be found absolutely self-supporting and quite strong mechanically as well as efficient electrically. It is advisable to bind the end turns to the celluloid strips with short bits of cotton thread in order to insure rigidity.

CONSTRUCTION

In the construction of this set, a hard-rubber baseboard was used and it was raised from the table a distance of about one inch, to allow for wiring under the sub-panel and permit the placement of the variable grid-leak and the rheostat in the manner shown. By using this form of construction, a much neater set results. It will also be noted that instead of using the regulation socket, ordinarily employed, what is known as a set of four “sockettes” was used. These make exceptionally good contact with the tube prongs, though they were not used in an attempt to produce lower losses. Here is a point in connection with short-wave work that should be stressed. It is not at all necessary to remove the base from the tube in order to make that tube operate satisfactorily as a detector at 40 or 20 meters. In fact, that inveterate experimenter, John L. Reinartz, finds no trouble in making a UV-199 type of tube oscillate and detect at 5 meters, and this with the base intact.

Dealers and Set Builders

It will pay you to investigate and build sets with our amazing new transformers. Highest efficiency, perfectly tuned and matched to exact peak. Designed for high power receivers. Also manufacturers of T.R.F. receivers and highest quality tubes and accessories.

IMPERIAL RADIO CORP., Chicago, Ill.
1945 Wabansia Ave.

BAKELITE KNOBS

permanently hold their color and finish. Write for Booklet 24.
BAKELITE CORPORATION
247 Park Avenue, New York, N. Y.
Chicago Office: 636 West 22nd St.
BAKELITE CORPORATION OF CANADA, Ltd.,
163 Dufferin St., Toronto, Ontario, Canada



Reserved for the
CAMFIELD RADIO MFG. CO.
829 Harrison Street
Oakland California

Insure your copy reaching you each month. Subscribe to Radio News—\$2.50 a year. Experimenter Publishing Co., 53 Park Place, N. Y. C.

THE VARIABLE CONDENSERS

In order to spread out the band on the dial and thus make tuning easier, a standard 11-plate variable condenser was obtained, and plates were removed until the total was only 5. This can easily be done with practically any variable condenser on the market today. If it is of the type using washers for spacers, remove some of these washers. If the plates are set into slots in metallic strips, they may be removed by the careful use of a pair of flat long-nosed pliers. In any event, the resultant capacity of the tuning condenser 4 should be in the neighborhood of .000125- μ f.

The regeneration condenser 5 may be a standard instrument of .00025 μ f. capacity and its construction need not be changed in any way whatsoever.

An R.F. choke is quite essential in this circuit, except that when audio frequency amplification is used, it is sometimes unnecessary. When used, it consists of approximately 125 turns of No. 28 or 30 D.C.C. wire on a 1-inch form. It will be noted at 9 in the diagram and illustrations.

An adjustable grid-leak is quite essential for use in this circuit as, without it, any short-wave set cannot be operated at its best. The grid-leak is carefully adjusted until manipulation of the oscillation control sends the circuit into oscillation with a soft hiss and with no trace of a click in the headphones. At this point the grid-leak should be left at its determined value.

VERNIER CONTROL

On the 20- and 40-meter bands particularly, the use of a vernier control is an absolute necessity. On the 80- and 150-meter bands it is not so necessary, but still it is a convenience. Therefore, it should by all means be included. The writer prefers to use either a friction type of vernier dial or else the vernier attachment shown in the panel view. This consists of a double-reduction arrangement fastened to the panel with a single screw, and so constructed that the friction wheel can be placed into contact with the edge of the dial or else pulled up out of contact so that the dial can be easily rotated in the usual manner. With the double reduction afforded by this little vernier, very fine tuning can be obtained and the results are very pleasing. On the oscillation control, a vernier is not needed as this is not critical in adjustment. Therefore, a standard type of 4-inch dial with a large knob, for the sake of convenience, is employed.

LIST OF PARTS USED

- Antenna Coil. Secondary Coil.
- Plate Coil.
- Variable Condenser, .000125- μ f.
- Oscillation Control Condenser, .00025- μ f.
- Variable Grid Leak.
- Grid Condenser, .00025- μ f. Rheostat.
- R.F. Choke. Detector "Sockettes".
- "A" Battery Switch.
- Dials, two 4-inch, one with vernier.
- Panel and Baseboard, each 7x14 inches, hard rubber.
- Binding Posts, Mounting Screws, Brackets, etc., as shown.
- Approximate Cost, \$25.00.

IT is against the policy of RADIO NEWS to publish the names of manufacturers or makes of instruments in connection with the apparatus described in these pages, but this information will be gladly given privately. If you are interested in any special instruments described here, address a letter to the I WANT TO KNOW DEPARTMENT, enclosing stamped return envelope. The names and addresses of the manufacturers will be given free of charge. —EDITOR.

The New Triple Duty GOLD SEAL HOMCHARGER



Charges at five Amperes!
The only battery charger that rejuvenates tubes
• supplies current for power tubes!

It's more than just a battery charger—the new Triple Duty Gold Seal Homcharger.

This year the new Triple Duty Homcharger gives you the same fast efficient charging rate. It replaces current in the battery at 5 amperes—three times as fast as other chargers—it fully charges the average battery OVERNIGHT! It uses no bulbs, no liquids—it is shockproof, fire-proof, approved by insurance underwriters. Can be used for radio or automobile batteries.

Rejuvenates Lifeless Radio Tubes

The new Triple Duty Gold Seal Homcharger is the only battery charger that rejuvenates radio tubes. By the Homcharger process tubes can be brought back to efficiency in absolute safety without removing them from the receiver.

Supplies 8-volts Current for A. C. Power Tubes

Another new exclusive feature is the special A. C. power tube terminal for operating the new 8-volt A. C. amplifying tubes. Homcharger is a perfect step-down transformer—provides constant uniform current direct from the light socket.

Despite its many exclusive features HOMCHARGER costs no more than any other charger. Complete, \$19.50 nothing else to buy

["Behind the Scenes in a Broadcasting Station", an interesting, 24-page booklet, together with literature describing the new Triple Duty Homcharger, will be mailed free on request.]

DEALERS Send for full information on this most efficient of all battery chargers.

THE KODEL RADIO CORPORATION, 501-521 EAST PEARL ST. CINCINNATI, O., U. S. A.
Owners and Operators of Broadcasting Station WKRC

Battery Chargers Power Units **KODEL** Radio Receivers Loud Speakers
POWER SPECIALISTS SINCE 1912

You Can't Equal This Value!

Five Tubes \$60
Two Dials

This two-dial control receiver is an outstanding example of Distantone value. It employs two stages of radio frequency, a detector and two stages of matched audio amplification and challenges comparison with any other receiver for volume and performance. Richly finished two-toned cabinet with a control-board panel harmonizing with the balance of the cabinet. Wave length range 180 to 550 meters.



MODEL "E"

Distantone

"Built By Craftsmen"

TO DISTRIBUTORS

Other Models from \$37.50 to \$150

The Distantone line* one of the few real profit lines in radio. For reliable and financially responsible distributors and jobbers, we have an exceedingly attractive proposition for the coming season. Write or wire today for full particulars or samples.

The Distantone line includes five tube receivers of two and three dial control and five and six tube sets with single dial control; all Tuned Radio Frequency type. Every model a superior value for the price.

DISTANTONE RADIOS, Inc., LYNBROOK, LONG ISLAND, NEW YORK



Plug a Jewel Pin-Jacks Voltmeter—

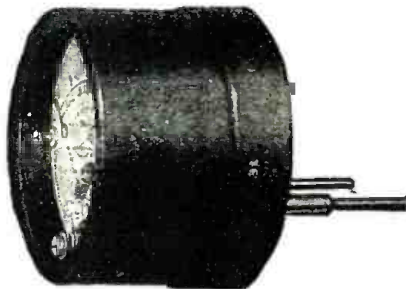

No. 135-A

into the two pin-jacks which Victor, Radiola, Brunswick and other manufacturers are installing in the panel of their sets—then it will be easy to regulate the filament voltage of your tubes.

Send For Special Circular.

Jewell Electrical Instrument Co.

1650 Walnut St. - Chicago
"26 Years Making Good Instruments"

HAVE YOU SEEN THE NEW MAGAZINE?

For Men and Women Who Want to Become Independent



The Magazine of Opportunity
Earn a Second Income

25¢ ON ALL NEWSSTANDS

See Page 270

The Latest Discoveries in the Range of Electromagnetic Wave-Lengths

(Continued from page 219)

hope that his apparatus, when further perfected, could be applied for transmission of signals at a distance, using quick electric oscillations, as soon as there could be found a source of such oscillations having sufficient energy.

These examples, taken from the domain of radio, call to the writer's mind the verse of Horace, "*Risum tenentis amici*" (withhold your laughter, friends). This is addressed to those who may feel some contempt for the latest achievements in the realm of the shortest electromagnetic waves, because of the minuteness of the energy, which has been radiated in the following experiments. It is true that it would be rather bold to predict that the waves of the semi-deserted region of 12-16L, covered only by a few wave-lengths of Glagoleva-Arkadieva and Levitskaia, will traverse the air of our planet in the future as numerous as do now the radio waves from 29L to 36L; but it would also be presumptuous to assert the contrary.

POSSIBILITIES OF THE DISCOVERY

There is another point on which the writer, personally, would like to venture some considerations. At present radio occupies the atmosphere with merely "*monochromatic*" (of one frequency) electromagnetic radiations, and uses receivers with pronounced selective resonating absorption; while optical telegraphy uses "white" light—the opposite of monochromatic—for such a receptive instrument as the eye which absorbs principally the most powerful part of the emitted spectrum. Glagoleva-Arkadieva and Levitskaia have made also vigorous efforts to monochromatize the radiations of their oscillators.

This is right from a scientific standpoint; but for the needs of radio it would be as well to aim at the production of a really "white" light of the shortest electromagnetic waves (or longest infra-red—who

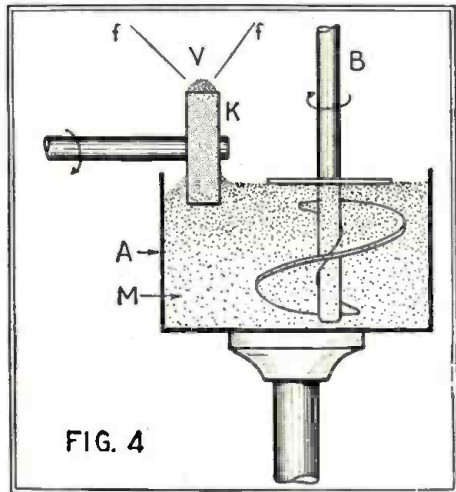

Details of Mme. Glagoleva-Arkadieva's "mass radiator," explained on opposite page. The metal particles carried on the wheel K serve as terminals of minute Hertzian oscillators.

knows?), thus attaining possibly intensities over such a spectrum (not in millionths of a calory per second, but kilowatts and hundreds of kilowatts) and using for its reception no selectively absorbing, but possibly totally integrating, "Black Electromagnetic Receivers." Such a white electromagnetic "light", which, owing to the shortness of the wave-lengths can be easily polar-

ized and transmitted over great distances, could be used also to solve the problem of directional radio transmission. We may live to see it; and it is to be hoped that these two eminent physicists and others will persevere in the study of this interesting region of frequencies which joins light and radio.

THE LATEST RUSSIAN EXPERIMENTS

The experiments of Glagoleva-Arkadieva and Levitskaia, which will be described in the remainder of this article, were preceded by those of P. N. Lebedev, who, in 1895, measured waves around 6 mm. and observed others half this length; and of Lampa, who, two years later, measured waves 4 mm. long. The writer asked the late Prof. Lebedev why he did not continue along the lines of Hertz's experiments and he answered that he had descended from Hertz's 60 cm. wave to 20 cm. in a couple of days; then down to 6 cm. in a couple of weeks, to 2 cm. in a couple of months and to 6 mm. in a couple of years.

The shortest electromagnetic waves of 3 to 6 mm., which made possible for Lebedev the discovery of the doubly-refractive properties of electromagnetic waves in crystals of sulphur, as to make corresponding polarizing prisms and to repeat all Hertzian experiments using a single goniometer stand, afforded no special incentive to him to go further towards the shorter wave-lengths. The absence of such an incentive was accentuated by the fact that the other shore of the Ocean of the Unknown, which then divided the Island of Electromagnetic Waves from the Island of Light Waves, was about six octaves distant, the longest infra-red wave-length actually measured then being equal to 56 μ .

But when, in 1911, Rubens by using the method of residual rays ("Reststrahlen") reached 400 μ (0.4 mm.) and measured with sufficient precision the wave-length 0.343 mm., interest in the unknown waves was again excited. However, several later attempts were unsuccessful, even the researches of Nichols and Tear in 1922, which shifted the record to 1.8 mm. and 0.8 mm.; and only by the two Russian women above mentioned, has the gap been bridged. Their researches are as yet incomplete, but enough has been done to warrant the above statement.

THE EXPERIMENTAL OSCILLATOR

A single Hertz oscillator presents great difficulties in producing short electromagnetic waves owing to its quick volatilization at the terminals. This causes instability of the emitted energy, as well as of the wave-length, which is increased gradually. In 1914 Prof. V. K. Arkadieiev started investigating the generation of short electromagnetic waves, by using a great number of Hertzian oscillators instead of one. These experiments were discontinued shortly after the start of the World War; and only after some seven years has his wife, Mme. A. A. Glagoleva-Arkadieiva, successfully elaborated the idea of using a great number of small oscillators, which are quickly interchanged in order to prevent their destruction, and if volatilized, to replace them with new ones.

The "mass radiator" of Glagoleva-Arkadieiva (Fig. 4) consists of a mixture of aluminum and brass filings with viscous machine oil. This mixture is continually stirred by an agitator, B, to form a more or less uniform paste, which is called the "oscillator paste," and indicated at M. The latter is carried along by a small rotating "carbolite" wheel, K, which has a diameter of 32 mm. and is about 10 mm. in width, thus forming on it a sort of sticky tire. Through the upper part, V, of this tire there is passed, by means of the conductors,

ELECTRAD

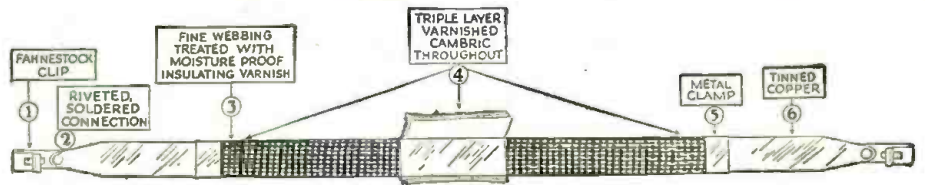

"THE SIX-POINT LEAD-IN"

Improved Reception with ELECTRAD Accessories and Parts

NO LOSSES, no troubles, with this Electrad Certified Lead-In. Just study this sketch and see why. REAL insulation (10 inches long), three-ply, covered with water-proof webbing. One-piece copper strip, tinned to prevent corrosion. Fahnestock clips, all connections RIVETED and SOLDERED.

Fits under locked windows or doors. Can be bent to any shape. No need to ruin walls, door or window trim.

For your own protection and to insure perfect reception, demand the Genuine Electrad Certified Lead-In. Beware of cheap imitations. Price U. S. 40c. Canada 60c.

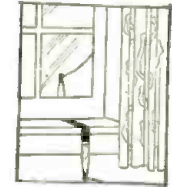

Want Clearer, Purer Reception? Do This: Place an Electrad Certified Audiohm

across the secondary of your transformer. Get the low notes and high notes full, clear and undistorted. Whatever set you have, the Audiohm will make it better. Can be attached instantly. No soldering. Comes all equipped. Buy one today. Good radio stores have them. Price U. S. \$1.50. Canada \$2.10.

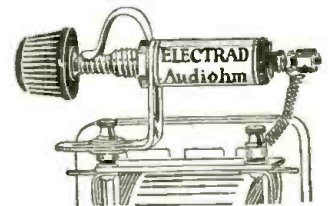

For Perfect Tone and Volume Control, Use ELECTRAD ROYALTY 500,000-OHM COMPENSATOR

The remarkable results secured by the use of this Perfected device are due to the fact that it controls the output without any distortion or noise, so that pure music is received. Note these six important features of design and construction: 1—Resistance element is not exposed to any mechanical operation. 2—Electrical contact is made positive by a metallic arm on the wire-wound strip. 3—The same resistance is always obtained at the same point. 4—The resistance value is under control in the process of manufacture and does not change in use. 5—The entire range of resistance is covered with less than a single turn of the knob. 6—There is no mechanical binding and the shaft is turned over the entire range with a perfectly smooth operation. Made in various types for various purposes. Prices, \$1.50 to \$2.00; in Canada, \$2.10 to \$3.00. Write for circular.

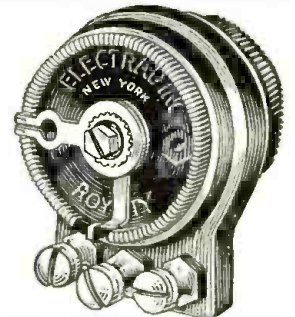

For Perfect control of tone and volume use the Electrad 500,000-ohm compensator. For free hookup write 428 Broadway, New York City.



ELECTRAD Inc

Chemistry paves the road to Success!

Some people measure success in terms of money and others in degree of knowledge and culture. Chemistry is the one uncrowded profession today that offers both. America, always a land of amazing opportunities, is especially so now in the field of applied Chemistry. Industries have developed within eight years more rapidly than the output of trained men to conduct them. Every big industry needs chemists and there is a real demand for them immediately.

Earn a Bigger Salary from now on—

Good Chemists Command High Salaries; you can make yourself independent for life by unearthing one of Chemistry's undiscovered secrets!

Do you remember how the tales of pirate gold used to fire your imagination and make you want to sail the uncharted seas in search of treasure and adventure? And then you would regret that such things were no longer done. But that is a mistake. They *are* done—today and every day—not on desert islands, but in the chemical laboratories throughout your own country. Quietly, systematically, the chemist works. His work is difficult, but more adventurous than the blood-curdling deeds of the Spanish Main. Instead of meeting an early and violent death on some forgotten shore, he gathers wealth and honor through his invaluable contributions to humanity. Alfred Nobel, the Swedish chemist who invented dynamite, made so many millions that the income alone from his bequests provides five \$40,000 prizes every year for the advancement of science and peace. Herman Frasch, who showed how to extract sulphur built up a huge fortune. C. M. Hall, the chemist who discovered how to manufacture aluminum made millions through this discovery. F. G. Cottrell, who devised a valuable process for recovering the waste from the flue gases, James Gayley, who showed how to save enormous losses in steel manufacture, L. H. Baekeland, who invented Bakelite—these are only a few of the men to whom fortunes have come through their chemical achievements.

NOW IS THE TIME TO STUDY CHEMISTRY

Not only are there boundless opportunities for amassing wealth in Chemistry, but the profession affords congenial employment at good salaries to hundreds of thousands who merely follow out its present applications. These applications are innumerable, touching intimately every business and every product in the world. The work of the chemist can hardly be called work at all. It is the keenest and most enjoyable kind of pleasure. The days in a chemical laboratory are filled with thrilling and delightful experimentation, with the alluring prospect of a discovery that may spell Fortune always at hand to spur your enthusiasm.

YOU CAN LEARN AT HOME

To qualify for this remarkable calling requires elaborate specialized training. Formerly it was necessary to attend a university for several years to acquire that training, but thanks to our highly perfected and thorough system of instruction, you can now stay at home, keep your position, and let us educate you in Chemistry during your spare time. Even with only common schooling you can take our course and equip yourself for immediate practical work in a chemical laboratory.

EASY MONTHLY PAYMENTS

You don't have to have even the small price of the course to start. You can pay for it in small monthly amounts—so small that you won't feel them. The cost of our course is very low, and includes everything, even the chemistry outfit—there are no extras to buy with our course. Our plan of monthly payments places a chemical education within the reach of everyone.

SPECIAL 30 DAY OFFER

Besides furnishing the student with his Experimental Equipment, we are making an additional special offer for a short while only. You owe it to yourself to find out about it. Write today for full information and free book "Opportunities for Chemists." Send the coupon right now while it is fresh in your mind. Or just write your name and address on a postal and mail it to us. But whatever you do, act today before this offer is withdrawn.

DON'T WAIT—MAIL COUPON NOW!

CHEMICAL INSTITUTE OF NEW YORK, Inc.

Home Extension Division 9

66-R West Broadway

New York City

Our Course
Will Fit You
For a Position
of Authority



LETTERS

From Students Who Have Taken This Course

You will probably be pleased to learn one of the lessons gave me an idea to turn my chemical knowledge to profitable account. I am now making a varnish and paint which undersells the other type products by \$2.60 a gallon, in some cases more. Have been receiving gallon orders from painters during past week which has netted me a profit of \$12.50 for my "spare-time chemical industry." Many thanks for your training thus far.

J. J. KELLY.

I am but half way through your course and am certain that I have saved my Company many times the cost of the course and raised myself in the Share Holders estimation. The knowledge obtained has its immediate practical application and I do not hesitate in saying your course and the personal attention you give is invaluable to the practical man in any business where chemistry plays a part. You may use this letter and my name and address to the furtherance of your good work.

JOHN WALTER.

I have not written since I received the big set. I can still say that it far exceeded my anticipations. Since I have been studying with your school I have been appointed chemist for the Scranton Coal Co., testing all the coal and ash by proximate analysis. The lessons are helping me wonderfully, and the interesting way in which they are written makes me wait patiently for each lesson.

MORLAIS COUZENS.

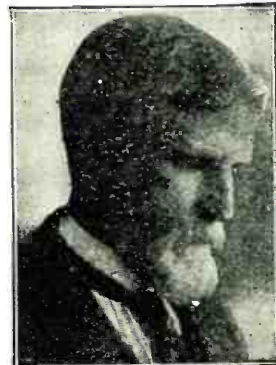

T. O'CONNOR SLOANE,
A.B., A.M., LL.D., Ph.D.

Noted Instructor, Lecturer and Author. Formerly Treasurer American Chemical Society and a practical chemist with many well known achievements to his credit. Not only has Dr. Sloane taught chemistry for years but he was for many years engaged in commercial chemistry work.

EXPERIMENTAL EQUIPMENT FURNISHED TO EVERY STUDENT

We give to every student without additional charge this chemical equipment, including forty-nine pieces of laboratory apparatus and supplies, and forty different chemicals and reagents. These comprise the apparatus and chemicals used for the experimental work of the course. The fitted heavy wooden box serves not only as a case for the outfit but also as a useful laboratory accessory for performing countless experiments.

CHEMICAL INSTITUTE OF NEW YORK, INC.

Home Extension Division 9

66-R—West Broadway, New York City

Please send me at once, without any obligation on my part, your free Book "Opportunities for Chemists," and full particulars about the Experimental Equipment given to every student. Also please tell me about your plan of payment and your special 30 day offer.

NAME

ADDRESS

CITY

STATE

R.N. Sept.

f-f, the discharge of a 15-cm. spark coil, (4 amperes, rotor interruptor).

The lengths of the waves emitted from V depend largely on the dimensions of the metal grains of the paste, and from the same sort of filings different results are often obtained. This is attributed to the difference in the size of the filings; and so, in order to obtain consistent results, Mme. Glagoleva-Arkadieva has used three sorts of filings. The sizes of these filings are:

No. 1 Mean length about 2.2 mm., mixed with finer ones down to 0.5 mm.

No. 2 Mean length about 1.4 mm., mixed with finer ones down to 0.4 mm.

No. 3 Mean length about 0.5 mm., mixed with finer ones down to 0.04 mm. and under.

These three mixtures also contained a fine metallic dust.

The emitted energy was twice as great from the No. 1 filings as from the No. 2; but this greater emission was unsteady owing to the wheel, K, being not broad enough in comparison to the dimensions of the filings. The second group was found to give the best results.

MEASUREMENT OF THE WAVES

The method used in these measurements was developed by Holtzman and is shown in Fig. 5. Here P1 and P2 are two parabolic mirrors. At the focus, F1, is the oscillator-paste, V, mentioned above; and at the focus of the second, F2, is a thermoelement, T, protected from the action of the waves by a screen, H, until the energy is to be measured. S1 and S2 are two plane mirrors (glass silvered thickly on the front) and the latter is movable by means of a micrometer screw, with head divisions corresponding to displacements of 25 μ.

This source of radiation produces wavelengths from 50 mm. down to 0.082 mm. Concerning these "ultra-shortest" waves the investigator* says: "They possess some kind

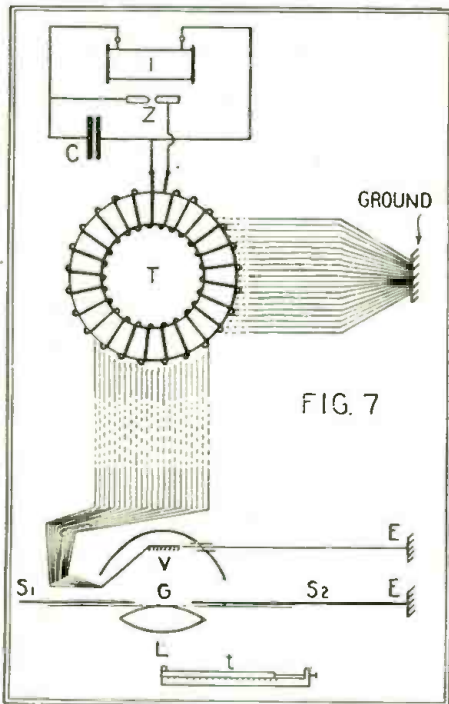

FIG. 7

Mme. Levitskaia's multiple-oscillator system, explained on page 297. The wave-lengths are computed from the readings of the thermoelement, t.

of a 'white' electric spectrum and are the result of the independent electrical vibrations in very small oscillators; but they are

*A. Glagoleva-Arkadieva "A new source of short electric waves of ultrahertzian frequency," Trans. State Electr. Research Instit. No. 2 20 pp., Moscow, 1924 (Russian with an English abstract); Phys. Zeits., 24, 153-163, 1924 (German); preliminary communication Sept. 19, 1922, at the third meeting of the Russian Assoc. of Physicists (Trans. of the meeting, 39, Niznij-Novgorod, 1923).

Only the Best Radio Parts are good enough for a Good Set

All Benjamin Radio Products are of the same high standard as the far-famed Cle-Ra-Tone Sockets —

Quality in every part of a radio set is depended upon for true-to-life reproduction of radio. There dare not be a flaw anywhere. And all the parts must synchronize. Each Benjamin Radio Product fits in perfectly with the power and conditions of the set and contributes greatly to its sensitivity, selectivity, volume and quietness. The use of Benjamin Radio Products in every part of the world — by authorities and amateurs — endorses the quality and effort that the Benjamin Electric Mfg. Co., has put into each product.

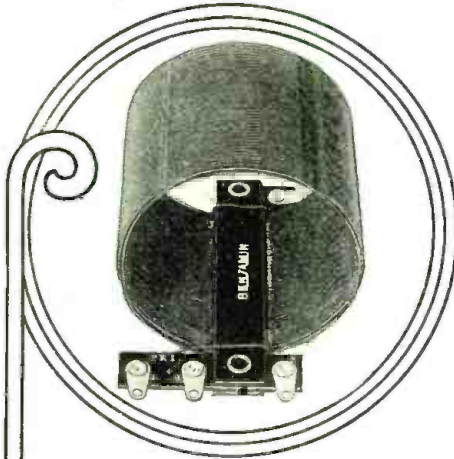

Improved Tuned Radio

Frequency Transformers

Proved through exhaustive and comparative tests to be the most efficient coil for modern radio sets. Better in all important features and characteristics. Space wound. Basket weave. Cylindrical. Highest practical air dielectric. Gives wonderful sharpness in tuning, better volume and purer tone quality.

2 1/4" Diameter Transformer

Compact. Especially desirable for crowded assembly. Eliminates interfering "pick-up." Set of three, \$5.75—Single Transformer, \$2.10.

3" Diameter Transformer

Capacity coupling reduced to lowest degree. For use with .00035 Mfd. Condensers. Set of three, \$6.00—Single Transformer, \$2.25.

"Lekeless" Transformers

Uniform high inductance, low distributed capacity and low resistance. The external field is so slight that it permits placing coils close together without appreciable interaction. Single Transformer, \$2.50.

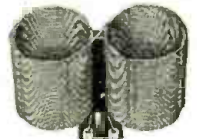

Brackets

An aid to simplification in set construction. Support sub-panel, with room underneath for accessories and wiring. Plain and adjustable. Plain 70 cents per pair; adjustable \$1.25 per pair.



Push Type Cle-Ra-Tone Sockets

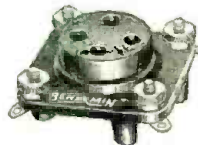

Spring Supported, Shock Absorbing. Stop Tube noises. Greatest aid to non-noisy operation. Contacts always clean. 75 cts. each.

Battery Switch



Quick, positive, clean-cut make and break. When it's "in" it's "off," eliminating danger of wasteful use of battery. 30 cents each.

Straight Line Frequency Condensers

No crowding of stations. The broadcast range is spread evenly over the complete dial. Stations come in without interference, and tuning is much easier. An instrument made with the precision and compactness of a watch. Adjustable turning tension. Low loss characteristics give a definite and distinct radio reception. Beautiful in appearance—a credit to the looks and efficiency of any set. Finished in dull silver. Made in three sizes:

- .00025 Mfd., \$5.00
- .00035 Mfd., \$5.25
- .0005 Mfd., \$5.50

See Benjamin Products at the Radio Shows

San Francisco, Calif., Aug. 21-28. Booth 87.
New York, N.Y., Sept. 13-18. Booth 9, Sec. CC.
Chicago, Ill., October 11-17. Booth 9, Sec. P.

Benjamin Electric Mfg. Co.

New York 120-128 S. Sangamon St. San Francisco
247 W. 17th Street Chicago 448 Byrant Street
Manufactured in Canada, by the Benjamin Electric Mfg. Co. of Canada, Ltd., Toronto, Ontario



Sterling RADIO INSPECTORS



Pocket Meter



Panel Meter

No. R-25-28
Filament MeterNo. R-32
Charge IndicatorNo. R-411
Tube TesterNo. R-406 Universal
Tube Tester

Be Protected Against the Common Ailments of Radio Reception!

NO set is so good that it can continue to entertain satisfactorily night after night without some servicing and inspection on your part.

To make it easy for every set owner to give the receiver the care it deserves, Sterling has produced complete Care-Taking and Inspection Equipment.

These devices for keeping your batteries and tubes in healthy condition, for locating troubles, and for promoting better reception, should be a part of your radio equipment.

Write for our helpful literature or see your nearest dealer.

The Sterling Mfg. Company
Cleveland, Ohio



Sterling RADIO CARE-TAKERS

No. R-111 Bulb Type
A & B Battery ChargerNo. R-900 Vibrating
Type A & Auto
Battery ChargerNo. R-101 Bulb Type
Trickle ChargerNo. R-403 Tube
ReactivatorNo. R-225 Midget
Tube Reactivator

not the overtones of the oscillators or resonators, which are usual in the work of other experimenters."

The advantages of the mass-oscillator can be listed as follows:

(a) It possesses a sufficiently great energy of emission,

(b) It can operate for hours at a time,

(c) It is free from the necessity of constant regulation of the exciting spark. During its work each spark which passes through the oscillator-paste meets a great number of pairs of metallic grains at widely-varied distances; the pairs, which are divided by distances at which the passing spark is active, are those which possess the emissive capacity,

(d) The wave-length does not diminish, because the oscillators are not overheated by the exciting spark, owing to their large quantity and to their rapid change on the tire of the rotating wheel.

ANOTHER METHOD

Mlle. Levitskaia had the same idea of increasing the quantity of energy radiated at each discharge; and also excited many oscillators simultaneously, although she did not distribute them over three dimensions but over a plane surface. In 1923** she used the smallest shot procurable and dissolved the surface layers of them by means of hydrochloric acid, until the diameter of the spherules became less than 1 mm. From the latter she selected, using a microscope, those which were nearest to a perfect sphere and had a diameter between 0.80 and 0.85 mm. These were embedded in a layer of Canada balsam at the intersections of a rectangular network of lines, less than 2 mm. apart, cut by a diamond on a glass plate. Between each two spherules of fifteen rows (each row consisting of 25 spherules) was placed a wire 0.3 mm. thick and about 0.5 mm. in length. The discharge of an induction coil, having a spark length of 20 cm., could be sent along several—not more than five—of these rows simultaneously.

In her experiments made at the Physical Laboratory of the Tashkent University, Mlle. Levitskaia did not measure the wave-lengths, but only estimated their order as being 1-mm. to 0.1-mm. The evaluation was based on the fact that the waves passed freely through an optical diffraction grating (10 lines to 1 mm.), the lines being rubbed with graphite and which could be embedded with a thermo-element with the resonating medium. The latter was paraffin, with copper particles dispersed through it when it was melted, from a copper electrode, until the solution became brown-black. This mixture contained about 350 visible particles, 0.02 to 0.08 mm. to the cubic centimeter, the rest being ultramicroscopical; and the copper content was 0.008 gm. per cubic centimeter.

In further experiments† Mlle. Levitskaia paid still more attention to the quantity of energy which could be radiated during each discharge, than to the uniformity of the oscillators, using two vibrator systems. The first consisted of pieces of molybdenum wire, 0.2 mm. thick and from 0.1 to 0.4 mm. in length, pasted to a Canada balsam layer on a glass plate in parallel rows, the distance between the rows being about 1 mm. Fig. 6 is the reproduction of an unpublished photograph (magnified about eight times) of a part of such a system. The second system was identical except for the length of the wires, which was increased to about 1 mm.

In order to make the spark jump simul-

**M. Lewitsky. "Ein Versuch von den kurzen elektrischen zu den langen Wärmewellen zu übergehen," Phys. Zeits., 25, 107-109, 1924.

†M. Lewitsky "Elektrische Wellen im Gebiete des äusseren Ultrarot," Phys. Zeit. 27, 177-182, 1926 (German).



A B-6 DETECTOR in your set assures the maximum of Quality, Volume and Distance.

PRICE \$5

For Set Builders: We have prepared blueprints with full details of a circuit especially adapted to the characteristics of the B-6. Mailed on request.

THE
DONLE-BRISTOL
CORPORATION
Tremont St.,
Meriden - Connecticut

Valet Auto Strop Razor FREE

With every five months' subscription to RADIO NEWS we are offering free — one genuine regulation sized Auto-Strop Razor.

SEND \$1 Today and get Radio News for five months and one Razor free.

EXPERIMENTER PUBLISHING CO., Inc. - - 53 Park Place, New York, N. Y.

taneously through several rows of oscillators, Mlle. Levitskaia used the following method: The poles of an induction coil, I, in Fig. 7, were connected to a condenser C, a zinc spark-gap, Z, and the primary coil of a transformer, T, which had 25 separate secondary coils. Each of the latter had one end grounded, and the other connected to one end of each of the 25 rows of the oscillating system, V, the other ends of these rows being also grounded. This system was placed in the focus line of a parabolic mirror, and in front of it was the orifice of a grounded metallic screen, S1, S2, a diffraction grating, G, a rock salt lens, L ($F = 17$ cm., $d = 5$ cm.) and a moveable thermo-element, T, connected to a Dubois-Rubens galvanometer of 9-2.10 sensibility. The curve, showing the correlation between the deflections of the galvanometer and the displacement of the thermo-element from the central point together with the diffraction-grating constant, gave the wave-lengths directly. (Fig. 3 illustrates the deflections, theoretical and observed.)



WRNY Celebrates Its First Birthday

(Continued from page 212.)

The Corporation Counsel of New York City, Arthur Hilly, poured forth some of his inimitable jokes. If you ever want a speaker to keep any crowd in stitches, engage Arthur Hilly.

I'm not going to attempt to repeat the list of folks who were there. But Dr. Miller, spokesman of the Protestant churches of the city; Dr. Goldstein of the orthodox synagogues; Dr. Landman of the Jewish Circle, and Dr. Reisner were the religious leaders. Arthur Guiterman, the rhymer, and Wolf Gilbert, the popular song leader, were also present.

And at 9 o'clock there came the demonstration of the Pianorad, the latest radio musical instrument, invented by Mr. Hugo Gernsback, Editor of *RADIO NEWS*. The Pianorad uses a keyboard like a piano, 25 vacuum tubes, and 25 loud speakers. The instrument gave beautiful flute-like tones that could be changed to the quality of an organ when desired. It is a development of the well-known Staccatone. It will be de-

New-way shaving

More and more men are discovering it

Self-shaving in a professional manner with a barber-edge blade, speedy, super-comfortable. This is the daily delight of all who own Valet AutoStrop Razors.

Not amateurish. Not a substitute. But a better shave in every way.

Simpler. This unique razor sharpens its own blades. No unscrewing. No disassembly. Sharpen, shave and clean without removing the blade.

More economical. A new-like blade for every shave. The utmost in self-shaving satisfaction.

Valet Auto-Strop Razor

REG. U. S. PAT. OFF.

AutoStrop Safety Razor Co., 656 First Avenue, New York City

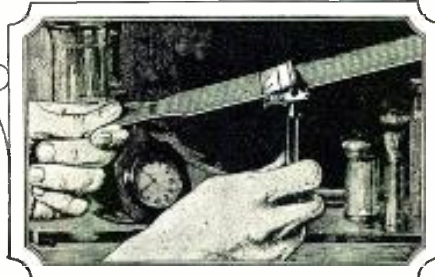

The Razor That Sharpens Itself

AMAZING STORIES

September, 1926, Issue

"IN THE ABYSS" by H. G. Wells. A most impressive story by this famous author; it gives at once a weird and a picturesque portrayal of life at the bot-

tom of the ocean, the roofless temples and houses and strange beings.

A COLUMBUS OF SPACE, by Garrett P. Serviss. We are now in the middle of this rather marvelous story by one of our favorite authors, whose work is so highly appreciated by our readers. It brings us towards the close of the romance, but leaves the reader in interested suspense.

THE PURCHASE OF THE NORTH POLE, by Jules Verne. This is the first installment of one of this master's best stories. He selects America for the opening scenes of this tale, and certainly has caught the atmosphere on this side of the ocean.

STATION X, by G. McLeod Winsor. This exciting story (for it has now reached that pitch of interest) here comes to an impressive end with a terrible naval battle; and at last, as a culmination, a happy-ending love affair, which will appeal to all readers.

THE MOON HOAX, by Richard Adams Locke. This is the famous Hoax that was perpetrated by the N. Y. Sun nearly 90 years ago. It describes the Lunar inhabitants as seen through an enormous telescope; and is told so well that many people at the time firmly believed it. It was entirely fictitious.

PRICE 25c PER COPY
AT ALL NEWSSTANDS

Goodrich Silvertown Radio Panels



For greatest range and selectivity

- 1 Easier to drill and machine.
- 2 Better color, lasting lustre.
- 3 Lower free sulphur—no discoloration.
- 4 Higher softening point—no warping.

Goodrich V. T. Sockets
Radiophone Ear Cushions

Spaghetti Tubing
Battery Mats

Hard Rubber Tubes for Coils

The B. F. Goodrich Rubber Company
Established 1870 Akron, Ohio

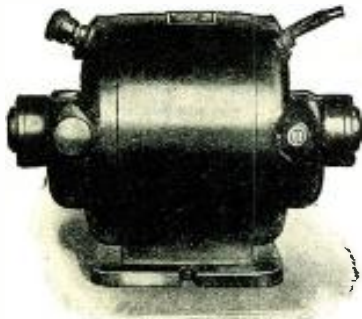

AGAIN ARCTIC EXPLORERS DEPEND UPON "ESCO"

The S. S. Chantier which Byrd used as a base was equipped with an "ESCO" dynamotor. This is the second time that an Arctic explorer has depended upon "ESCO" equipment for communication with the rest of the world.

ELECTRIC SPECIALTY COMPANY

211 South Street TRADE "ESCO" MARK Stamford, Conn.
Manufacturers of Motors, Generators, Motor-Generators and Dynamotors.

Byrd Crosses the Pole!

Commander and Pilot Make Round Trip In 14 Hrs. 13 Min.

Oslo, Norway, May 10.—Lieut. Commander Richard E. Byrd and his pilot, Floyd Bennet, returned to King's Bay, Spitzbergen, at 6.30 p. m., and declared they had flown over the north pole in the Byrd expedition's monoplane, according to advices from King's Bay.

scribed in full in the October issue of RADIO NEWS.

THE EDISON MUSIC BOOK

The Edison Hour goes merrily along. Harry T. Burleigh, the negro singer, came back, and Beniamino Riccio, the operatic baritone, made his debut with the Edison Ensemble, while the Ukrainian Chorus gave a colorful program. Speaking of the Edison Hour reminds me to offer you their new wonderful book, "A World Tour of Music," which is very important, in that it tells you about the music of nine nations, their composers and important compositions, and is handsomely illustrated. Write me and I will see that you get a complimentary copy.

And talking of things complimentary, I am also empowered to offer a free pass to the wonderful amusement park, Starlight Park, to anyone who writes me here. To New York visitors this assures one solid evening's pleasure (bathing, opera, shoot the chutes, etc.) And one further offer: Madame Helena Rubinstein, famous beauty expert, who is now speaking over WRNY, is giving a free beauty reading to the ladies. Her fee is ordinarily a high one (she has been adviser to empresses, queens, leaders of society and the stage), but if you who read these words will write Madame Rubinstein, care of WRNY, and ask her for advice, she will be glad to help you to know yourself. Lest I have not made it clear, this is for the ladies exclusively.

NOVELTY PROGRAMS

I am particularly proud of the novelties, which have crowded WRNY's famous Friday night 10:15 hour. There was the epic of June Brides which apostrophised life, love and marriage. Then came the group which were transported from Hawaii and other points distant by Wally Gluck. Did you join us the night we had the "Campfire in the Woods," or did you travel to Czechoslovakia when we had a "Night in Prague?" The Czech Consul, Mr. Broz, was there to guide us on the last mentioned affair.

Far from the fields of novelties, came the heralded debate of Norman Thomas and Hugo Gernsback. The Socialist leader, former minister of the conservative Brick Presbyterian Church, a some-time candidate for the Governorship, attacked with sincerity the radio "interests." Mr. Gernsback defended, not the "interests," but the intentions of the radio industry and broadcast operators.

That was the night when Alice Brady appeared in the Edison prize play, "The Return of Mary Ellen," following Grant Mitchell and preceding Louise Closser Hale and Olive Wyndham. Next month I'll tell you a story of the opera, and a few other things far removed from such a chronicling of events, but WRNY does not have a birthday every month.



Read "AMAZING STORIES"

The Magazine of Scientifiction—Something
New, Novel, Interesting—Don't miss
the Big September Issue

25c—ON ALL NEWSSTANDS

"Echoing Silence"

(Continued from page 213)

nerve-tingling allurements was in one of the four houses irregularly grouped in the middle of the block. This knowledge, with the ending of the piano number, I reluctantly decided was all that I as a stranger could expect to have; even though the design and building of improved radio sets was my spare time hobby. With a disappointed frown I continued my walk until, as luck would have it, as I passed the last house an old man in overalls and faded blue shirt, with a bibulous nose reminiscent of our country's pre-alcoholic days, came slowly down the walk from the house towards a neglected lawn mower, lying on the half-cut lawn.

Complacently puffing his old cob pipe, he spat from the opposite corner of his mouth and said with friendly enthusiasm: "Evenin', stranger! Wha'do you think of our neighborhood entertainment?"

"Without a doubt the best music I've ever heard over the radio," I replied, and was hastening to take advantage of the opening to inquire its whereabouts, and what chance I might have to look it over, when I was cut short by the loquacious old gentleman remarking:

"Since that Stebbins boy lit onto his last wireless trick, the radio boxes in this here part of town don't get much lookin' after; and if his luck holds out we'll just set back and let him do all the knob twistin' for the rest of us, 'cause none of us in hearin' distance of his set can begin to get the smart results he does."

"I'm sort of a novice along that line, myself," I began, "and I surely would like to have a chance of look—"

Brushing my small talk aside as if he considered it insignificant in view of the startling statements he had to make, he continued: "There ain't none of us around here as has had enough readin' up on radio to know what 'tis in them boxes that makes 'em work; but the Stebbins boy's been fiddlin' around with them little coils 'n dials 'n lights ever since people first started goin' looney over wireless stuff. He read everything in the Carnegie library here 'n then he signed up for some studyin' to be done by mail; 'n what with that and fixin' up the neighborhood sets when they go on the bum, 'n buildin' a new set for himself every week or so, they ain't none in this part of the state his equal for knowin' what's all about. Last December he was showin' a radio salesman, who was in town for a couple o' days, a little kink he'd figured out for improvin' some part of his set; and I'm darned if the company that salesman's working for didn't go ahead and patent it and put it on all their own sets. 'N do you think young Stebbins got anything out of it? Nary a red cent!"

"But take it from me, Mister, he's got something worked out now that's goin' to lack 'em all off the map. Yes sirree, bob! You know part about it already, 'cause I saw you were takin' it all in comin' down the walk while that last pianner piece was playin', but you don't know the half of it. He hit on this new stunt several months ago after workin' every night till all hours; 'n last March durin' a late cold spell we just sat in our own 'dinin' rooms by the fire and listened to programs from all over the States without turnin' a single knob on our own receivin' sets. Open the windows? No, that's one kinda spooky thing about his new contraption. It goes through everything just like they say the wireless waves do. Don't make no difference where we're settin'—upstairs, downstairs, windows open or closed,

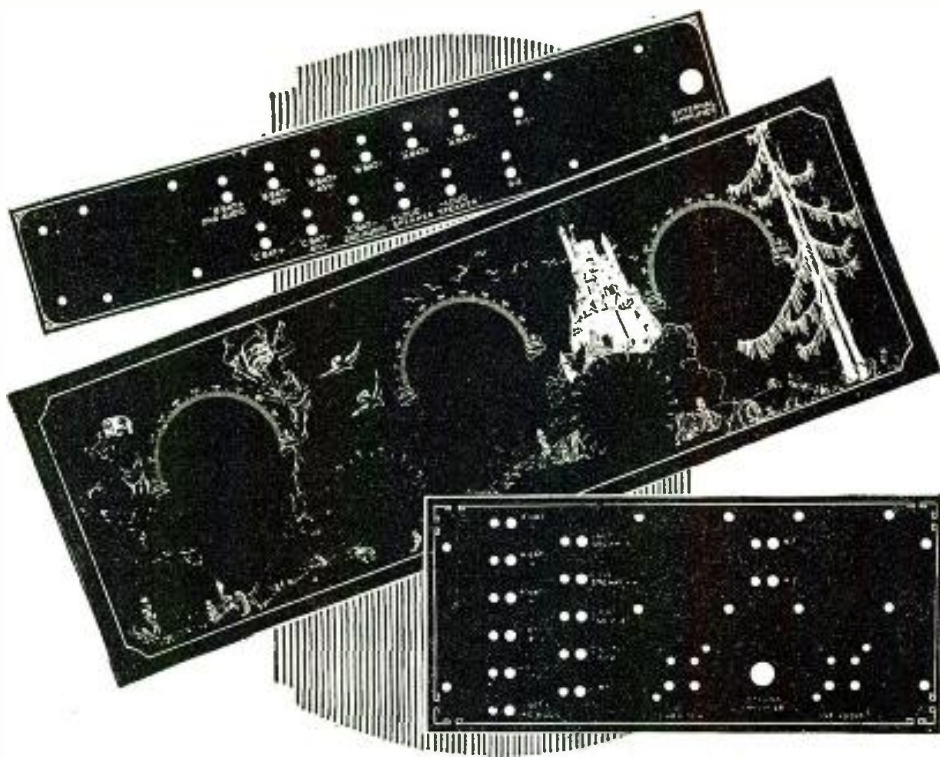

Punched and Veri Chromed Formica Base Panels

ON high-grade sets this year punched Formica base panels marked in gold by the Veri Chrome process will be very widely used. These panels have a very attractive appearance and give the interior of the set a finished appearance.

The panels may be had in either high gloss or mat finishes. The markings may be either gold or silver. For front panels Veri Chrome decoration in much greater variety of effects is now available. Some sets will have elaborate pictures. Others simple severe decoration. Dull satin finished wood effects are available.

FORMICA PANELS FOR KITS

Veri Chrome decoration has been applied to panels for numerous well-known kits. These include: Madison-Moore Superheterodyne; Victoreen Superheterodyne; Bremer-Tully Counterphase 5 and 6; Browning-Drake National; General Radio Universal Receiver; and L. C. 26 Cockaday.

Panels in standard sizes are sold in neat trade-marked envelopes. Special sizes may be had on order.

THE FORMICA INSULATION COMPANY

4618 Spring Grove Avenue Cincinnati, O.



FORMICA

Made from Anhydrous Bakelite Resins
SHEETS TUBES RODS

U. J. Herrmann
Managing Director

G. Clayton Irwin Jr.
General Manager

Radio Manufacturers' Show Association
Presents

Third Annual RADIO WORLDS FAIR
Madison Square Garden
New York City
Sept. 13-18-1926

Fifth Annual CHICAGO RADIO SHOW
Coliseum
Chicago
Oct. 11-17-1926

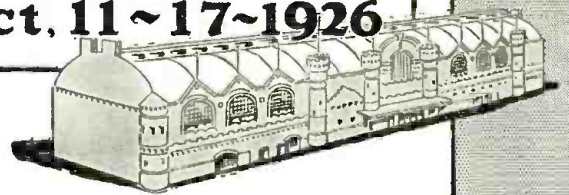

**The World's Foremost Radio Exhibitions Held In
The World's Foremost Exhibition Halls**

Every representative radio manufacturer will display his new products—a complete showing of everything new in radio. Thousands of new, novel, and sensational features for everyone interested in radio. This is the one show you can't afford to miss.

"Go to the RADIO SHOW"

There is only one Show in New York this year.

150 Radio Hookups!

NEW!

The finest selection of modern circuits obtainable

WHAT more could you ask?—150 of the very finest, selected hookups most popular today. Each one completely explained and fully illustrated so that complete receiver can be constructed at home. No out-of-date Hookups—all the finest and best in common use today.

It is compiled by the staff of RADIO NEWS.

The book contains 64 Pages, all illustrated, and is printed in the large size 6 x 9 inches.

Don't miss this opportunity—All Radio and News dealers have fresh copies Now. If there is no dealer near write us direct enclosing 25 cents.

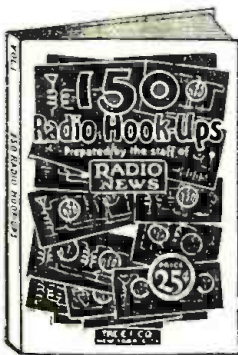

Published by the
E. I. COMPANY, Inc.

Distributed by

The Consrad Company, Inc., 64 Church St., New York, N. Y.

25^c ON ALL NEWSSTANDS

Consrad

THE LARGEST PUBLISHERS OF RADIO BOOKS AND PATTERNS

down cellar or out on the front porch—just plain one place as 'nother. No, I don't try to explain it—it's too deep for me, and I doubt if I could explain it even if he told me; and he ain't telling nobody about it this time, you can bet on that, after his experience last year with that no 'count travelin' salesman.

"Like to take a look at it? I don't know who you are, and reckon he don't neither, but maybe he'll let you take a look at it from a distance. Reckon even if you had a mind to you couldn't steal his idea by lookin' at the set from the outside. Let's walk over and see if he has any special objections to lettin' you take a distant squint at it."

Naturally, I made no objections to accompanying him if even to get only a "distant squint," as he said. My only fear was that my eagerness would be construed as an ill-covered desire to make the boy's new-found secret my own. To allay my eagerness I endeavored to occupy my mind with speculations as to which of the houses we were approaching contained the radio genius we sought. I was therefore quite taken by surprise when we turned in on the front walk leading to one of the houses which was not surmounted by an aerial. To the question in my eyes the old man said:

"Storm we had here last winter blew down all the aerials around here. Young Stebbins was the only one among us who didn't put his up again; 'cause he said he didn't have any use for one anymore."

Which was another check mark for good work to be put against the Stebbins' ingenuity.

As was customary in these old-fashioned towns, we went around the house to the kitchen door to inquire for the young man and were met at the door by young Mr. Stebbins, himself, who was just coming out with a large bucket in his hand. Having already learned my name the old man introduced us; telling Stebbins in explanation that I had had my curiosity piqued in my chance passing while the broadcast was on, and that he had volunteered to bring me over just for a closer look at the set. He hastened to add that I did not care to inquire into the secret of the discovery but merely wished to learn the results he had accomplished.

Except for a bright pair of intelligent eyes and a firm, agreeable mouth, there was nothing about the young man to set him off from the ordinary run of Young America. Although I am poor at judging ages, I would place his at about twenty-two, a scant dozen years less than my own. The questioning look with which he regarded me when we were first introduced soon changed to frank enthusiasm when he learned that radio, although not my business, was at least my pet hobby. And I could tell from his rush of words that he recognized in me a friend and an opportunity to discuss intelligently the latest developments in the science which was closest to his heart, but the least understood by friends and relatives in his native town.

"I'm just on my way to water my ground," he explained, indicating the bucket in his hand. "As you've probably noticed, I don't use an antenna; but I'm still finding a good ground of the greatest importance. If you'll wait just a few minutes until I water the ground, while it's still light enough to see, I'll be with you again. Or if you're interested, there's no secret about my ground system if you care to look at it."

Stepping to a nearby water tap he filled the bucket, during which I noticed a small funnel soldered to the lip of the bucket in a horizontal position.

"I generally do this with a hose," he said, "but the neighbors sometimes forget to return things they borrow. Even our lawn mower's away from home most of the

The diamond of the air!

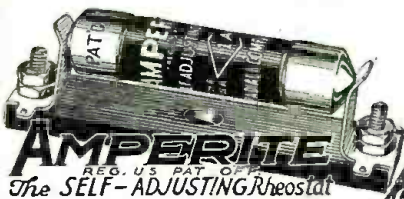

AMPERITE
REG. U.S. PAT. OFF.
The SELF-ADJUSTING Rheostat



AEROVOX

Aerovox for Accuracy for quality for results the contribution of experts for the Diamond of the Air.

Chosen for the Diamond of the Air because of its durable construction and high standard of efficiency.

Used to govern precisely the heating of the detector tube and also in the last audio stage permitting the use of any make of tube, including the U.X. power tube.

"Bruno"



\$22⁵⁰

Licensed Under Armstrong Patent 1,113,149

Its Brilliance Outshines Them All

Just like its name "DIAMOND" of the air—this receiver stands out by its brilliant performance, head and shoulders above the ruck of mediocrity. Beautiful tone, instant thrilling power and knife-like selectivity are all combined in the "DIAMOND". Now you can not only get the thrill of building a good receiver at home—but the additional thrill of constructing one of Radio's finest—by using the new "DIAMOND" kit shown above.

GENERAL RESISTOR

General Resistor for Precision Leaks, Resistors and Ballast supplied for the Diamond of the Air by General Resistor.



All parts in this kit are ready for use. It consists of the following parts: 1 Bruno 99 Tuning Coil, 1 Bruno 99 R.F. 2 Bruno S. F. Condensers (Bakelite Shaft) 3 Bruno Vernier Dials, 1 Bruno Light Switch

BRETWOOD GRID LEAK

England's finest Craftsmen Donate their Best in the Bretwood Variable Grid Leak.



The Complete Kit for the "Diamond of the Air" Consists of the Following Parts:

1 Complete Bruno Diamond Basic Kit and 3 1/4 Amp. Mounted Ballast Amperite, 1 1/2 Amp. Mounted Ballast Amperite, 1 3/2 to 1 Audio Transformer Bruno, 2 0.1 meg. resistor General Resistor, 1 1.0 meg. leak General Resistor, 1 0.5 meg. leak General Resistor, 1 Variable Grid Leak, Bretwood, 2 Double Circuit Jacks, 1 Single Circuit Jack, 1 7x24 drilled and engraved panel, 1 Socket strip complete with 5 sockets, 1 Pr. Bruno Brackets, 2 0.25 mfd. fixed condensers, 1 5-strand multi-colored battery cable De Luxe, 1 A Switch, 5 Battery cable markers, 4 Binding posts, Bus bar, screws, nuts and spaghetti.

PRICE

\$37⁵⁰

COMPLETE BOOK OF INSTRUCTION AND BLUE PRINT

COMPLETE

for sale by

B. C. L. Radio Service Corp., 223 Fulton St., New York

THE TUBE WITH THE SPECIFIC GUARANTEE

The Dam Support!



Vibrationless Uniform and Good The construction of a dam is no better than its supports—they are equally important.

There are three elements in a radio tube. The slightest movement in relation to each other causes a characteristic change, invariably disqualifying the tube.

—

THE NEW SUPERTRONS HAVE SUPPORTS THAT TIE THE THREE ELEMENTS INTO ONE UNIT

—

The Base and Supports are ISOLANTITE

—

All types at public demand prices

SX 01 A	\$2.00
SX 99	2.25
SV 99 small	2.25
SV 99 large	2.25
SX 12 (Power)	5.00
SX 20 (Power)	2.50
SX HiMu	3.00
Supertheon Half	4.00
Supertheon Full	5.00

In Canada slightly higher.

—

Full Details on Request

SUPERTRON MFG. CO. Inc.

HOBOKEN, NEW JERSEY

Chicago Office 30 N. Dearborn Street
Export Dep't, 220 Broadway, N. Y. C.

SUPERTRON
The Foremost Independent Tube in America

time," with a mischievous sidelong glance at the old man who seemed to be in trouble with the draught of his cornob pipe.

"I reckon you don't miss it much," was the retort, after a prodigious, red-faced blow through the offending pipe stem. "Bet a persimmon this is the first time today you've stopped monkeyin' with them wireless waves long enough to get up out of the house. Do you good to come over and push your mower 'round awhile, even if 'tis on my lawn."

With a laugh Stebbins bent to his work; which consisted in pouring water through the funnel into a series of small pipes, which stuck out above the ground a few inches, about a foot and a half apart.

"My ground is composed of several large pieces of fine copper netting," he said "each one about ten feet square and separated from each other with a layer of charcoal and cinders. The ground wire is soldered to the corner of each one. I've got them buried about four feet deep but the soil is so sandy here that the water drains away almost as fast as I pour it down these pipe into the charcoal. You'd be surprised how it peeps up the set when I keep these pipes filled twice a day."

Having filled the last pipe, he invited us into the house and took us to the small room he had fitted up as an experimental laboratory. I was surprised to note how completely he had supplied himself with all the paraphernalia needed for experiments in both electrical and chemical subjects; and I remarked to him how well prepared he seemed.

"Yes," he answered, "I've found chemistry so closely allied to electricity and radio that it seemed best to obtain a basic knowledge of that science as well; and the deeper I get into the subject of radio the more need I find for additional knowledge in the broad lines of physics, especially pertaining to light, heat and sound. I've had to do so much studying lately in broadening my field that I haven't found much time for actual experimenting. What little I have found time for has been centered around my accidental discovery of *soundless* radio reproduction.

"That sounds like a paradox, but it's the best descriptive name I could think of for the physical manifestation. You see, I was experimenting along the line of improvement in the auditory reproduction of the radio signals in some form of loud speaker; whether horn, cone, or what-not, mattered little as long as some radical improvement could be effected. You know what very good results are obtained in listening to speech or music by means of a good pair of head phones, and also what very poor signals come through when a loud speaker is used with the necessary added stage or stages of audio-frequency amplification.

"Taking as a basic constant the theory that the signals as impressed on the carrier wave are much truer to life than the signals we obtain after passing the induced current through our receiving set and loud speaker, I believed that great improvement could be made, and that the field for this improvement lay in the stages after the detector tube and in the loud speaker itself. With this desired end in view I have experimented with every audio-frequency hook-up which has been published to date, and in addition have worked through innumerable hook-ups of my own invention, some good, some bad, and some impossible. Out of all of these experiments one stood out as unusually good; and it was while working one night with a set constructed along the indicated lines that I received a caller who introduced himself as a traveling salesman with one of the large metropolitan radio manufacturers. As

"Still In the Lead"



The TOBE B-BLOCK was the first filter-condenser unit placed on the market, for use especially with the Raytheon type B Tube in Socket B-Power devices. Containing the necessary TOBE Filter Condensers, equipped with terminals at the bottom of the case, for shortest and safest wiring, it reduces the cost of B-Eliminator construction very considerably below the use of separate condenser units.

Price—\$11.00
And still in the lead



TOBE "VERITAS" HI-CURRENT RESISTOR

A special over-size unit for B-Eliminators, and transmitting grid leaks, capable of carrying 4 to 5 watts continuously without change or deterioration. In all values.

TOBE DEUTSCHMANN CO.
Engineers and Manufacturers of Technical Equipment
CAMBRIDGE MASS.



Silent "B" Power with World Radio Storage "B" Battery.

12 Cells 24 Volts

Lasts Indefinitely—Pays for Itself

Dependable. Quiet "B" power, clear without "hum." Economy you have never before thought possible. Convenience. Outstanding performance. Recharged for almost nothing. Solid rubber case insures against leakage or acid. Extra heavy glass jars. Heavy rugged plates. Approved and listed as standard by Pop. Radio Laboratories, Pop. Sci. Inst., Standards, Radio News Lab., Lefax, Inc., and other Radio authorities.

Extra Offer: 4 Batteries in series (90 Volts) \$10.50.

SEND NO MONEY! wanted and we will ship same day order is received. Pay expressman after examining batteries. 5 per cent discount for cash with order. Send your order today—NOW!

WORLD BATTERY COMPANY
1219 So. Wabash Ave. Dept. 75 Chicago, Ill.
Makers of the Famous World Radio "A" Storage Battery
Prices: 6-volt, 100 Amp. \$10.50; 120 Amp. \$12.50; 140 Amp. \$13.25.
All equipped with Solid Rubber Case.

World STORAGE BATTERIES

Set your Radio Dials for the new 1000-watt World Storage Battery Station, WSEB, Chicago. Always something interesting.

ROKA - WEST - WGN - WJIS - KPLI - KGO - KJAF - WJW - KGB

"Outsell, Because They Excell"

Empire All Types

Including NEW Detector (EX-200) High MU and Power Amplifier

Dealers and Jobbers Write for Prices and Folder "K"

EMPIRE ELECTRICAL PRODUCTS COMPANY
Laboratories & Factory—Kearny, N. J.
Sales Office—132-134 Green St., New York
Also Mfrs. of Empire Cone Loud Speakers

UNION RADIO TIP JACKS and IDENTIFICATION TAGS
UNION RADIO CORPORATION, Newark, N. J.

Learn Electricity

by practical, personal training in the great shops of COYNE

You don't need education or experience. COYNE-trained men earn \$60 to \$200 a Week

COMPLETE ELECTRICAL TRAINING in Twelve Happy Weeks

Free Railroad Fare Get my special offer of free fare to Chicago, also FREE courses in Radio and Auto Truck and Tractor Electricity. Ask for Big, Handsome FREE BOOK containing 151 actual photos of electrical methods and operations in Big Shops.

COYNE ELECTRICAL SCHOOL
Dept. 6776 1300 West Harrison Street, CHICAGO, ILLINOIS

TELEGRAPHY (Morse and Wireless) and RAILWAY ACCOUNTING taught thoroughly. Big salaries; great opportunities. Oldest, largest school. Endorsed by Telegraph, Railway, Radio, and Government officials. Expenses low—opportunities to earn large portion. Catalog free.

WODGE'S INSTITUTE Swan Street, Valparaiso, Ind.

welcomed the opportunity of perhaps learning some of the newer phases of the science, he talked and argued like old friends for several hours, in the course of which I mentioned my latest discovery and sketched for him on a piece of paper the hook-up which contained my improvement. I also explained at some length the construction of a couple of new parts which I had found necessary, even going so far as to give him the constants I had used in my calculations.

"The only radio store of which we can boast in this town is a little radio shop run by my brother as a side line in connection with his confectionery and book store, and where I generally assist him on the neighboring farmers' market days. Several months after the agreeable traveling salesman's visit, in checking over a small shipment of receiving sets which had just been delivered to the store, I noticed the neat set bearing the trade-mark of the salesman's house. Tracing through the wiring as was my custom in the new sets, that was my surprise to find my own hook-up incorporated; and concealed beneath the sub-base were the very instruments which I had so innocently described to their representative.

"An exchange of correspondence with the company disclosed that they had patented the new feature on the strength of a discovery made by one of their salesmen, to whom they were paying a royalty for his ingenuity. You can be sure that, after such an educational experience, I have found it necessary to clothe my latest discoveries with more secrecy, and I know you will not question my decision to disclose one of my latest successful experiments in detail.

"The fanciful, and I might say almost extraordinary, results which I obtained as the result of one of my theoretical experiments several months ago, has infinitely exceeded my fondest hopes and expectations. Ever since I stumbled upon this new application of a principle which has been known to science for some time, I have spent every possible moment upon its improvement; until now I am almost, but not quite, satisfied that it has been simplified and improved to a point where it can be patented and put on the market, with the assurance that the merest novice will be able to make use of it and easily keep it within his control.

"The receiving set there before you appears to be the ordinary two-dial-control receiver; and by lifting the cover you will note that the hook-up embodies three stages of tuned radio frequency, using twin condensers to tune the loop and radio stage, followed by the detector and what appears to be the little used but well-known three-stage resistance-coupled amplifier. I have no fear of your gaining an inkling of the extent of my discoveries by merely lifting the cover of the cabinet; for I have taken pains to attach the unusual parts below the sub-panel where they cannot be seen without removing the entire set from the cabinet. Not that I have any suspicions of your intentions, but I felt that this time I would protect myself from anyone who might chance to wander in upon me unexpectedly.

"I guess my talk must sound rather pedantic and bookish, but when I start on my pet subject I just naturally fall into the use of the phrases repeated over and over again in my studies. It's really quite a relief to be able to talk as I think, without the necessity of searching for common words that can be understood by non-technical minds. Old Pa Jenks here is no doubt snowed under by now," turning his head with a smile to the old man, who had seated himself in a comfortable rocker and was complacently puffing his refilled pipe.

"Go ahead with the barrage, boys," he

Special Subscription Offer!



This handsome
VALET Auto-Strop Razor
FREE
with every
5 months' subscription to

SCIENCE & INVENTION

The big Book of Scientific Events, News and Practical Developments from every corner of the world!

IN order to acquaint the readers of this book with **SCIENCE** and **INVENTION**, we are making, for a limited time, special reduced rates and are also giving **FREE** one complete **VALET** Auto-Strop Razor shown above.

For only \$1 (Regular Newsstand price \$1.25) you can obtain this magazine for five months and also, one **FREE** Razor —

This shaving outfit consists of a highly-polished, nickel-plated, self-stropping Razor; one blade, and a leather strop especially prepared. The razor case is of metal, finished in maroon, crystalized effect. Lined throughout with velvet, harmonizing with the pleasing color scheme of the entire package.

The only razor in the world that sharpens its own blades.

A Treasure in Itself

Science and Invention thoroughly covers every important and interesting event of the scientific or inventive world that occurs from day to day. All of the latest developments in Electrics, Patents, Chemistry, Mechanics, Magic and Phychic Phenomena, Automotive Subjects, etc., etc., are written up and illustrated. This fascinating magazine also makes a big hit with the radio beginner. In every issue the sound practical fundamentals of radio are carefully and completely explained and simplified.

The coupon is for your convenience, clip it today and pin a \$1 bill, money order, or check to it. Fill out the Coupon with your complete name and address NOW.

Experimenter Publishing Co.

INC.

53 Park Place

New York, N. Y.

PIN A \$1 BILL, MONEY ORDER OR CHECK TO
----- THIS COUPON -----

EXPERIMENTER PUBLISHING CO., Inc., Dept. R9,
53 Park Place, New York, N. Y.

Gentlemen:—Enclosed is \$1 for 5 months' subscription to **SCIENCE** and **INVENTION**. You are also to send me one complete razor as advertised **FREE**.

NAME

ADDRESS

CITY, STATE

SEPTEMBER
ISSUE

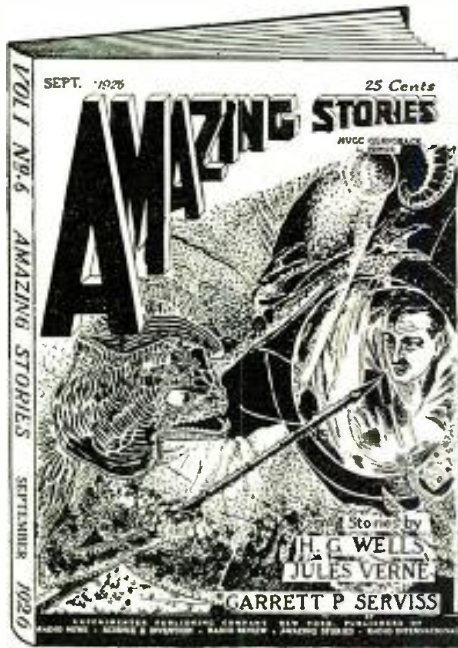

25^c the copy

Other feature stories in
September issue

THE PURCHASE OF THE NORTH POLE, by Jules Verne, in which some enterprising mathematicians and scientists attempt to bring the North Pole to a temperate zone—or bring the temperate zone to the North Pole. A stroke of lightning sets things flying in the mathematician's room and an error gets into the calculation. Of course, that upsets their plans considerably.

A COLUMBUS OF SPACE, by Garrett P. Serviss (2nd instalment) in which our adventurers continue their marvelous experiences with the Venusians on the light side of the planet Venus.

STATION X, by G. McLeod Winsor (Conclusion) in which the Venerian aids in a terrific battle against the Martians and Professor Rudge, at least, returns to tell the tale.

THE MOON HOAX, by Richard Adams Locke, is a classic science fiction story containing excellent science along with some obvious mistakes, which were not detected even by a scientific audience. It is probably the greatest scientific hoax that was ever perpetrated upon a credulous public.

BLASPHEMERS' PLATEAU, by Alexander Snyder, wherein some eminent scientists successfully experiment with infinite secrets, until they become drunk with their power. Then another scientist arrives on a friendly visit. It is a powerful and gripping story which is sure to hold your interest.

READ

In The **ABYSS** By H.G. Wells

Take a trip with this world renowned author to an amazing city—5 miles under water!

A spherical steel shell fitted with a glass window and containing an intrepid explorer descends five miles to the floor of the ocean.

A number of human-like, terrible monsters surround the shell and carry it away—what happens to the explorer and his steel house will keep you in breathless suspense.

Incredible things occur, yet, as the author himself explains, there is today no knowledge to refute the amazing sights the explorer sees.

No more remarkable story was ever written. It takes you away from everyday, humdrum happenings, for a moment, to a new land of wonders.

Don't miss it—Featured in "Amazing Stories" for September.

**BIG SEPTEMBER ISSUE OF
"AMAZING STORIES"
JUST OUT!**

Published by

Experimenter Publishing Company, Inc.
53 Park Place, New York City

Sold on All Newsstands

said. "I always do get a heap of mind rest by listenin' to a couple of furriners jabbering, 'cause I don't have to strain my ears tryin' to hear what they're sayin'."

With a chuckle, but with ill-suppressed eagerness, I turned my eyes again to the set, regretting the passage of every moment which did not add to my knowledge of the young inventor's discoveries.

"Before putting the set in operation," he continued, "a few words as to just what I meant when I called the new principle 'soundless radio reproduction' may not be amiss. The human ear, as you know, serves as an amplifier and a conducting passage for the so-called audible sound waves from the exterior world to the tiny mechanism of the inner ear, where the sound waves are converted into a stimulus to the auditory nerves, which in turn carry the sound impression to the brain. Now the ear is said to be unable to appreciate sound waves of a vibratory frequency of less than thirty vibrations per second, corresponding to the very lowest notes we hear, or the high notes of from forty to fifty thousand vibrations per second. That there are both higher and lower sound vibrations than we can ordinarily hear, all scientists are agreed; so that our inability to appreciate the multitude of overtones and harmonics which must exist can be laid only to what we might call our scientifically-insufficient ear mechanism. Compared to the ears of small birds and animals, or, a step farther, to those of insects, how gross and clumsy appears our own instrument of hearing.

"The theory I was working upon was that the auditory nerves, and of course the brain cells of hearing themselves, would respond to both higher and lower vibratory frequencies, were it not for the relatively clumsy insufficiency of our conducting ear. What I was seeking was a method of reproducing detected and amplified radio signals on a vibratory scale that would penetrate directly to, and stimulate the auditory nerves without the necessity of passage through the ear channel.

"With this idea in mind I have been working along the lines of what amounts to rebroadcasting the radio signals, after passing through the radio and audio amplifying stages and the detector, at a frequency appreciable to our brains but actually soundless as far as our ears are concerned. I believed that if I could, by chance or design, arrive at such a method I would in one step both nullify the need for a physical loud speaker and open up to our sense of hearing realms of musical tones literally unheard of and perhaps in musical circles revolutionary.

"Whether I have in some degree arrived at the results desired, I will let you be the judge."

Closing a small double-throw switch, which he later explained to me controlled his "A" battery charger and "B" battery eliminator, he slowly revolved the dials until we were suddenly surrounded by a burst of song which made my senses reel. A chorus of many voices filled the air and through and above all came marvelous strains of accompaniment, both string and reed, such as I may never hope to hear again. Up and up rose the melody, until I held my breath, every nerve in my body tingling and the very hair on my head seeming to stand on end. And then with a final heart-stopping but soul-filling chord as from a thousand throats and a hundred melodious instruments, the music ceased. I opened my eyes and caught my breath with a sob, unable to bring my dancing senses to a realization of where I stood. The very floor under my feet felt strange, and I couldn't have lifted a finger to save my life.

A voice which might have been coming from my own throat, for all that I could tell, except that it was so strange, seemed

PROVED!

17 Sewall St., Framingham, Mass., April 12, 1926.

Ferbend Electric Co. Dear Sirs—I have tried the "B" battery Eliminator which I purchased some time ago and find it works satisfactorily in every way. I have recommended this to several radio friends in this locality. I have had it on three different sets of five tubes each. Two of these sets are the tune I radio frequency and the other is a straight Freed-Eisemann set, fully neutralized. (Signed) Edw. A. Browning.

246 Florence Ave., Highland Park, Mich., April 26, 1926.

Ferbend Electric Co. Gentlemen—My reception is easily enhanced at least 50% since the installation of the Ferbend Eliminator, and, naturally I am a very enthusiastic "Satisfied Customer." Performance is far in excess of excellence that I have ever before experienced with the use of batteries. I am using a five-tube R. F. (Freshman Circuit), employing a "C" battery and am at a loss to know how I can at all improve it since using your Eliminator. In fact, I am so pleased that I solicit inquiries from such as may be your prospects. I have compared the performance of the "Maxmin" with others of far greater price and find that none produce the clarity of reception as does your instrument. (Signed) Wilson E. Rogers.

San Francisco, April 20, 1926.

Ferbend Electric Co. Dear Sirs—I have been using my "B" Eliminator steadily since I received it, and most say that it lives up to all the claims you make for it. This letter, I feel is the least I could do to thank you. (Signed) Philip A. Kelly, 1167 Valencia St."



\$12.50



COMPLETE nothing else to buy Replaces "B" Batteries. Operates Direct from Electric Light Socket, A. C. Power.

FERBEND "B" ELIMINATOR

Many careful buyers choose to adopt a policy of "watchful waiting." This is often true in the purchase of an apparently better, but yet-to-be-proved, automobile. The same holds good for many other commodities. And Radio. With the original announcement of the good Ferbend "B" Eliminator and its amazing low price of \$12.50, many there were who chose to wait. They wanted to be convinced. True, thousands bought at the start and they are the ones who now tell you what to expect. Lack of space alone prevents us from publishing the hundreds of fine testimonials from satisfied users. They are all in our files open to public inspection at any time. A few reproduced here.

The Ferbend "B" Eliminator successfully passed the rigid Laboratory tests of Radio News, Popular Radio and Radio Broadcast. It is a Proved Radio necessity, and a great one.

Ask Your Dealer—or Send Direct

If you prefer, we will make shipment direct to you upon receipt of price, or C. O. D., if desired. Use for 10 days to convince yourself—if unsatisfactory, write us within that time and purchase price will be refunded. Use the coupon now.

Ferbend Electric Co., 425 W. Superior St., Chicago, Ill.

FERBEND Wave Trap
This Company also manufactures the famous Ferbend WAVE TRAP—the instrument which has been widely imitated but never equalled. It is the only original and genuine. Priced at **\$8.50**

MAIL THIS COUPON TO-DAY!

FERBEND ELECTRIC CO., 425 W. Superior St., Chicago

Send at once, Payment enclosed Send C. O. D. Send Literature

Name.....

Address.....

City.....State.....



6-Volt Storage Radio "A" Battery

Most amazing battery value ever offered! A genuine World 6-Volt Radio "A" Battery with 25 ampere capacity for only \$5.00! Just the thing for Trickle Charger. Famous World Quality assured. Equipped with

\$5.00 C. O. D. Send No Money

Solid Rubber Case an assurance against acid and leakage. Order Now. We ship same day—by express C. O. D. subject to your examination on arrival. Extra Offer: 5% discount for cash in full with order. ACT TODAY!

World STORAGE BATTERIES WORLD BATTERY CO. Dept. 110, 1219 S. Wabash Ave., Chicago

WJLA WJAF WJGN WJMS KJLJ KGOZ KFAP WJY KOPR

FREE Radio Catalog



Just off the press! Our Special Summer Bargain Bulletin. Pages of parts, accessories, kits and sets—all the best and the latest. A \$1,000,000.00 Radio Stock to choose from. A copy of this unusual catalog is yours for the asking. Just drop us a line—now.

CHICAGO SALVAGE STOCK STORE Dept. R. N. 509 S. State St., Chicago, U.S.A

"Bring Buyer and Seller Together"

**FIRST ANNUAL
RADIO DEALERS
CONVENTION**

OF THE CENTRAL STATES

Will Be Held at
Indianapolis—
Wednesday, October 27, 1926

In Conjunction With the
**SECOND ANNUAL INDIANAPOLIS
RADIO
EXPOSITION**

OF THE CENTRAL STATES

Week of October 25 to 30, 1926
Manufacturers' Building—Indiana State Fair
Grounds

Three Big Sales Meetings
Nationally Known Speakers
Largest Radio Display
IN THE CENTRAL STATES

ALL UNDER ONE ROOF
In Indiana's Finest Exposition Building
Conducted By

SPECIAL TRADE COMMITTEE

Indiana Manufacturers & Jobbers
For Exhibit Space and Further Information

Address:
Broadcast Listeners Association
Care Indianapolis Radio Exposition
Corporation
1407 Merchants Bank Building
INDIANAPOLIS

\$75 A WEEK
BUILDING RADIO SETS
In Your Spare Time

Join the Radio Association of America. Learn how to build and repair sets. The Association will train you—start you out in business, if you wish. Be the radio "doctor" of your community. \$3 an hour upwards easily made.

EARN \$500 IN SPARE HOURS

"I have at last found myself," writes Lyle Follick, Lansing, Mich. "I have already made over \$500." Werner Eichler, Rochester, N. Y., writes, "...have made over \$50 a week in my spare time." Our members are starting radio stores, increasing their salaries, securing better positions, passing radio operator examinations, earning big money in spare time.

JOIN ASSOCIATION NOW!

Are you interested in Radio for pleasure or profit? Join now because we have a Special Plan whereby your membership need not cost you a cent. Only limited number of these memberships acceptable. Write now for details—before it is too late.

--- Mail This Coupon ---

Radio Association of America,
Dept. 159, 4513 Ravenswood Ave., Chicago
Send me details of your Special Radio Association
Membership Plan.
Name
Address
City State

AMPLION
FOR BETTER RADIO REPRODUCTION

to seep from the four walls, the floor, and the ceiling: "Station K—G—O, General Electric, Oakland, California. You have been listening to the Bay Cities Mixed Quartet, assisted by a special violin, saxophone and piano trio, who have just completed a selection from the opera "Aida." This concludes the program for this evening. We shall be pleased to hear from our radio friends either near or far telling us of their reception of our program this evening. Address all communications to Station K G O, General Electric, Oakland, California. We will be on the air again tomorrow morning at ten o'clock. Good-night."

"This is KGO's silent night," resumed young Stebbins, the sound of his voice hurling me down from the clouds with a violent start. "On nights when they're on the air in the evening until ten o'clock Pacific Time we're well entertained until midnight, due to the two hours' difference—provided everyone in the neighborhood is willing to stay out of bed that late. That's one striking disadvantage of this set—it can't be operated without everyone within a surprising radius being either willing or unwilling listeners. Of course the output can be materially reduced by turning down the filaments of the tubes, just as you would do to reduce the sound of your loud speaker, but operating even at minimum load the penetration is uncanny.

"Old Silas Danvers and his wife, who live in the last house on this street, are both deaf as the proverbial stone post, but they'll sit up all night if I'll give them good programs to listen to. Yes, it's the first music they've heard in a good many years and has opened up a new world to them. Whether or not this discovery will open up communication with our unfortunate mutes who are totally deaf, is something I have not yet had an opportunity to try out, as there are none living in this section of the state.

"You can test for yourself what I mean by the penetration. Close your ears as tightly as possible with your fingers or hands, then open them again when I give the signal." accompanying his words with an adjustment of the dials to a predetermined setting.

Suiting my actions to his words I pressed the palms of my hands tightly against my ears until I felt the ear drums stretch. Then suddenly I heard a loud, melodious voice speaking, and although my amazement was great I was able to comprehend that he was giving a minute description of the distinctive markings on various tropical birds. Stebbins raised his finger; at which signal I slowly dropped my hands, prepared for a sudden burst of sound as I freed my ears. That I was astonished is expressing it mildly, for I was unable to hear the least difference in volume. I again closed my ears and opened them, and repeated the operation several times, but I am willing to affirm that to the best of my belief there was not the slightest noticeable difference. I could not but accept this as conclusive evidence that my entertainer's statement as to the susceptibility of our minds to vibration without the necessity of our ears was based on fact.

"But how is it possible," I blurted out, as he threw the switch to allow the continuance of our conversation, "how is it possible that these tone waves, which would appear to be vibrating at audible frequency, since we have such a true reproduction of the actual tones, can stimulate the auditory nerves within our mind but seem to have no effect on our exterior, sensitive organs of hearing?"

"That," he replied, "is a phase of the subject open to argument. Whether or not the tiny instruments within our ears operate as usual when the passage is open, and operate in sympathy with the inner nerves when closed, is something that can be de-

PRICES CUT

World STORAGE BATTERIES at Cost!

LIMITED TIME OFFER!

For a limited time only, genuine World Storage Batteries can be gotten at actual cost. Every cent of profit has been cut out in order to keep our full factory organization busy during the slack season. Prices below are lowest in history.

World Batteries are nationally known for dependable, long wearing performance. Solid Rubber Case prevents acid and leakage.

Send No Money!

Just state battery wanted and we will ship same day order is received, by Express C. O. D. subject to examination on arrival. 5% discount for cash in full with order. Send your order now and get your World Batteries at actual manufacturing cost.

WORLD BATTERY COMPANY
1219 So. Wabash Avenue
Chicago, Ill.

Solid Rubber Case Radio Batteries	Set your Radio Dial for the new 1000 w. World Storage Battery Station W S S C, Chicago.	Solid Rubber Case Auto Batteries
6-Volt, 100-Amperes \$10.50	Interesting programs every night.	6 - Volt, 11 - Plate \$10.50
6-Volt, 120-Amperes \$12.50		6 - Volt, 13 - Plate \$12.50
6-Volt, 140-Amperes \$15.25		12 - Volt, 7 - Plate \$15.25

KDKA WSBC WEAF KYW

ELECTRAD

New!

ELECTRAD Heavy Duty Metallic Resistor

Specially developed for B eliminators and power supply units.

Special Features Are:

- 1—High current-carrying capacity.
- 2—Non-inductive. Accurate calibration.
- 3—Low temperature coefficient.
- 4—Resistance element fused to inside of Lavrock tube.
- 5—All standard high resistance sizes.

Price \$1.00; in Canada \$1.40
Ask Your Dealer For Detailed Circular

ELECTRAD Inc.
New York City

A NEW RADIO PLUG

Simple to use, gives perfect electrical contact with any style tip.

Simply push cord tip through plug, loop cord and push tip back into plug.

Sent postpaid on receipt of 50c
CULVER-STEARN'S MFG. CO.
Worcester, Mass.

mined only by a microscopic X-ray amination of the inner ear in actual creation. The fact remains, though, that these vibrations carry much farther than the usual sound waves could, and under circumstances that would absolutely deaden all ordinary sound."

(To be continued)

AS BURNS WOULD SAY

Ye, modest, crystal-tippit lure,
Ye struggled wi' ye for an' oor,
Draw upon your magic po'er
Wi slender stem;
Ye panel's fu' o' crystal stoor.
Thou stubborn gem.

Anna hear your music sweet,
'Syne you've got me in a heat,
Fling ye doon intae the street
Without a thocht;
Well you, man, I'm 's wat wi' sweat
As if I'd wroucht.

Side but twa-three miles awa'
Ye 5SC, an' yet, wi' 't a'
Anna hear a thing awa'—
A doonricht shame
At sic things should be 'sell't at a'
Wi' sic a name!

Ye tell't me I would hear them blaw
Ye trumpets miles an' miles awa',
Don't believe a word o't a'—
The lecin' brats!
Ye stage a turn to hate them a'
Wi' twa auld cats.

Thocht to spend my nights at hame,
Jyin' a' things as they came,
T, in or oot, it's a' the same—
This gear's nae guid.
I see that chap—he's maist to blame—
An' ha'e his bluid.

Wid sakes! O' a' the dolts, I'm ane!
Mann be gettin' unco blin'.
Ye 'phones—I've never fixed them in
To thae wee screws!
Ye guid job Betty isna in
To air her views!

I try again noo a' thing's richt;
Ye sure to hear the bawn th' nicht,
Ye, that's them noo, as clear 's daylight.
Losh, man, it's great!
Ye puir man, efter a', was richt—
'S a perfect trate.

Ye, modest crystal-tippit lure,
Ye tapped the magic o' your po'er.
So we'll hae mony a happy po'er.
The wife an' me.
Ye a' the ills I've found the cure—
It's 5SC!

—Glasgow Herald.

**Constructing
The Eusonic Receiver**
(Continued from page 230)

If you are very close to some broadcast station from which you can pick up loud signals, the circuit driver need not be used. The idea, of course, is to get a noise loud enough and comparatively steady, so that an accurate adjustment of the balancing condensers can be made. If you wish to use the signals from a local station to make the necessary adjustments, connect your aerial to the antenna binding post on the receiver, and follow the procedure outlined above. In either case, be sure to use a ground connection.

If signals are too strong, by simply rotating the rheostat indicated as R9, and decreasing the filament temperature of the detector and three audio-frequency-amplifier tubes, the volume may be controlled without in any way impairing the quality, which we are sure will satisfy even the most critical.

TUNING THE SET

What is most unusual, interesting, and remarkable about this set, as it was constructed in the RADIO NEWS LABORATORIES, is the novel means of tuning each tuned circuit to obtain a station. Although each variable condenser can be tuned separately, no dials are used. Special discs calibrated on the dials are employed for this purpose, being mounted on a novel shafting system

Again—Years Ahead!
B-T Originality and Leadership More Apparent
Than Ever In the
COUNTERPHASE-EIGHT
and the NEW
COUNTERPHASE-SIX

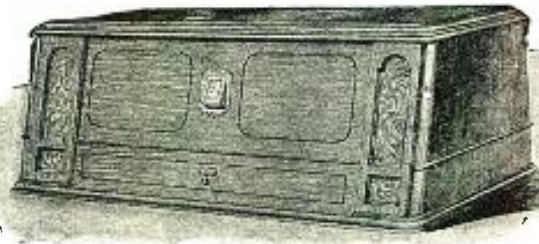

The success of the B-T Nameless of three years ago is known the world over. In it was introduced the original "oscillation control." This year many sets will "feature" various forms of tone controls, high wave switches and the like.

In the Counterphase B-T have accomplished the very thing for which all have been striving—*Sensitivity over the entire broadcast wave band* and it is done **WITHOUT AN OSCILLATION CONTROL** and in a set that cannot be made to oscillate.

The "Blooper" evil of course is also banished!

Simplicity is the key-note, and greater efficiency is the result.

"SELECTIVITY" does not adequately describe the ability of the Counterphase to reject stations not wanted. Through a new exclusively B-T arrangement, the Counterphase provides a degree of selectivity never before equalled *even in B-T sets*.

Even with this remarkable selectivity, the Counterphase is simple to operate. You turn only one knob to select stations and the *patented visual indicator* permits absolutely accurate calibration for the first time in any Receiver.

Other features too numerous to mention here are fully described in special circulars, sent free on request.

Dealers—authorized dealers only will sell Counterphase sets. Some territories still open. Investigate today.

BETTER TUNING

The 10th edition fully describes all the features of the new permanent model Counterphase Receivers and B-Power Units. Information on radio of value to anyone is crowded on every page. Sent on receipt of 10c in stamps or coin.



520 SO. CANAL STREET, CHICAGO, ILL.

B POWER UNIT

A Bremer-Tully B-Power Unit for Counterphase sets or any set up to seven tubes. Fixed resistances enable the user to know the exact voltage delivered to the set. It would not be on the market if B-T did not believe it superior. Special circulars free.

ALL-AMERICAN
Pioneers in the Radio Industry

MASS RADIO SCHOOL

18 Boylston St., Boston, Mass.

FALL TERM SEPT. 13

Send for free Catalog

Make any Good Receiver BETTER
CC TUBES
C.E. MFG. CO.
Providence R.I.

ACME
for amplification

Insure your copy reaching you each month. Subscribe to Radio News—\$2.50 a year. Experimenter Publishing Co., 53 Park Place, N. Y. C.

Watch for the Big FALL Issue!

50c
THE COPY

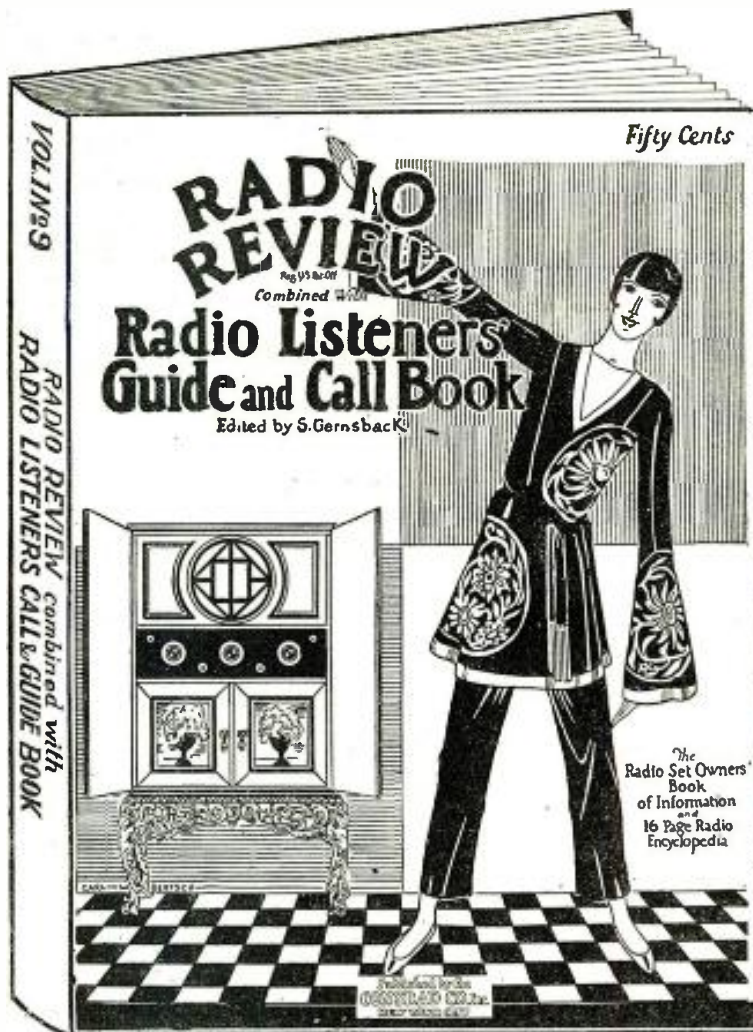

SOLD ON ALL NEWS-STANDS

Contents

BROADCAST STATIONS OF THE U. S.

(Alphabetically by call letters)

This section contains all the Broadcast Stations of the United States listed by Call Letters, giving location, Power, Wavelength, time and hours of operation.

BROADCAST STATIONS OF THE U. S.

(By Wavelength & Frequencies)

This is a complete list of Broadcast Stations of the U. S. same as above, but listed numerically by Wavelength for added convenience.

BROADCAST STATIONS OF THE U. S.

(By States & Cities)

Another way of listing all U. S. Broadcast Stations. Especially valuable when location of a given station is known but the call letters indistinguishable by Radio.

CANADIAN RADIO BROADCAST STATIONS

(By Provinces & Cities)

This section contains the finest revised list of all Canadian broadcast stations obtainable. Listed two ways.

FOREIGN RADIO BROADCAST STATIONS

(By Countries & Cities)

A section containing the latest, most complete list of Foreign Broadcast Stations ever published.

Contents

RADIO SET OWNERS BOOK OF INFORMATION

In this portion of Radio Review are a large number of selected articles each of great value to every Radio Listener whether he be a beginner, Amateur or Professional.

RADIO EXERCISE CHARTS

A guide to Radio Exercises containing helpful charts of actual exercises and similar information.

CONSTRUCTION OF MODERN CIRCUITS

Here is one of the latest additions to the great Radio Review—gives complete details with drawings on how to build at home the latest Radio Receivers.

S. GERNSBACK'S RADIO ENCYCLOPEDIA

Radio's finest Encyclopedia—One complete installment given in every issue of Radio Review—contains a whole barrelful of actual, authentic data and information on Radio from every angle.

ILLUSTRATIONS

Throughout the broadcast station lists are hundreds of illustrations of living performers and announcers, together with photos of broadcast stations.

The Radio Listeners greatest Call Book—and Book of information COMBINED

Imagine the finest, most up-to-date list of Radio broadcast stations obtainable—listed 3 ways for convenience and giving the operating hours of each station—add a dozen fine articles on the operation and care of Radio sets—More fine constructional articles and lastly a complete installment of S. Gernsback's Radio Encyclopedia—and you have the big, new Fall RADIO REVIEW—192 pages, large size 9x12 inches. Photographs of all living Broadcast Performers and Announcers and hundreds of interesting illustrations.

THE CONSRAD COMPANY, Inc.,
53 Park Place, New York, N. Y.

Gentlemen:—I enclose 50c for one copy of the new FALL ISSUE of RADIO REVIEW.

NAME
ADDRESS
CITY, STATE

IF YOUR DEALER CANNOT SUPPLY YOU USE THIS COUPON

The Consrad Co., Inc.
53 Park Place New York, N. Y.

which permits rotating the three condensers either separately or simultaneously. Each disc, which incidentally is made of bakelite, and enhances the appearance of the receiver, is knurled so that fine "finger-tip" tuning may be obtained without any lost motion between the hand and the disc. This knurl, or rough edge, on each disc also facilitates the rotating of all three at the same time; necessitating the use of only two fingers to rotate all three discs, thus controlling all three variable condensers. Each tuned circuit can be logged separately.

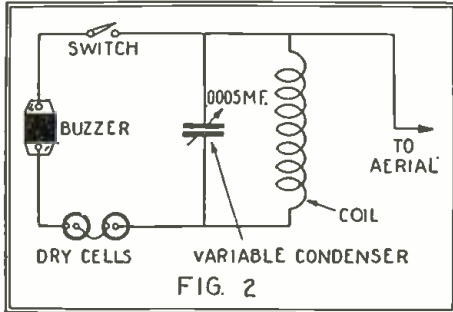

The simple "circuit driver," which furnishes the necessary signals while balancing the Eusonic receiver, if no local station is convenient.

If an ordinary three-gang condenser is employed, only one control or dial is used for tuning. However, in this case it will be best to insert two small midget vernier condensers, one in parallel with the first R.F. and one with the second R.F. condensers. This addition will permit compensating any difference in capacity or inductance between the R.F. stages.

IT is against the policy of RADIO NEWS to publish the names of manufacturers or of makes of instruments in connection with the apparatus described in these pages, but this information will be gladly given privately. If you are interested in any special instruments described here, address a letter to the I WANT TO KNOW DEPARTMENT, enclosing stamped return envelope. The names and addresses of the manufacturers will be given free of charge. —EDITOR.

CALLS HEARD

CLARENCE WOLF, JR., 1521 No. 16TH STREET, PHILADELPHIA, PA.—3ABH
 1abz, (1acd), 1ajm, 1ajx, 1auc, (1aqi), 1axz, (1azj), 1bbk, 1ber, 1bhm, 1bdr, 1bez, (1bhz), 1chl, (1dgl), (1pe), 1pi, 1qb, 1qc, 1sl, 1uc, 2aak, 2aav, (2abt), 2ad, (2adh), (2aldw), 2afv, 2agi, 2aha, 2ail, 2aig, 2aig, 2aje, 2akj, 2amb, 2amq, (2aop), (2ape), 2apt, 2aux, 2hsc, 2hsj, 2cep, 2egb, 2crp, 2ctn, (2cxl), 2ah, 2cp, 2jq, 2mt, (2ou), 2pb, 4hk, 4cu, (4fg), 4ge, 4ll, 4oa, (4sc), 4f, 4wg, 5ahp, 5aps, 5hur, 5fs, 5to, (5vvn), 6btx, 6cuc, 6hj, 6tr, 7ko, 7va, 8abs, 8aux, 8aow, (8atc), 8aul, (8axx), 8ayp, 8hlp, 8iin, 8hh, (8hzc), 8cag, 8cer, 8cep, 8cgr, 8cil, 8ejv, 8ckp, 8cux, (8cor), 8cqq, 8cta, (8ctt), (8cyp), (8cwg), 8lax, 8ldd, 8lcv, 8dgy, (8lkn), 8dol, 8dpr, 8dqq, 8dqh, 8hg, 8dq, (8cn), 8kf, (8uf), 8uj, 8uz, 8wp, 8yv, (8zi), 9adw, 9af, 9ahq, 9aiz, 9ajq, 9akj, (9apy), 9asx, 9atq, 9aup, (9awd), 9awc, 9axf, 9hhf, (9hca), 9hcy, 9hhh, 9hfg, (9hgc), 9hik, 9hjk, 9hli, 9hmy, 9htr, (9htx), 9hwg, 9hzi, 9caa, 9caj, 9cft, 9ckg, (9cvu), (9lco), 9lea, 9lgw, 9lkq, (9lhj), 9dvt, 9ebv, 9efe, 9ejq, (9eld), 9he, 9ei, (9cv), 9fp, (9jo), (9lz), 9mr, 9pt, 9rt, 9rk, 9vh, (9vj), 9wn, 9xm.

CANADIAN: 2am, 3dh, 3qs, nao, wiz, wir.
 Reception of each station listed, to the hour, on file, at 3abh, ORK mi 30 watts cw? A card goes out for every one that comes in.

A SHORT CIRCUIT

"—what do you think of the broadcasting of hook-ups?"
 "—great! I won't have to hook up my wife's dress any more.

BRICKBATS WOULD BE BETTER

Although radio experts claim that radiating receivers are small broadcast stations, it is a fact that the owners do not receive any congratulatory telegrams for their programs.

—Contributed by William G. Mortimer.

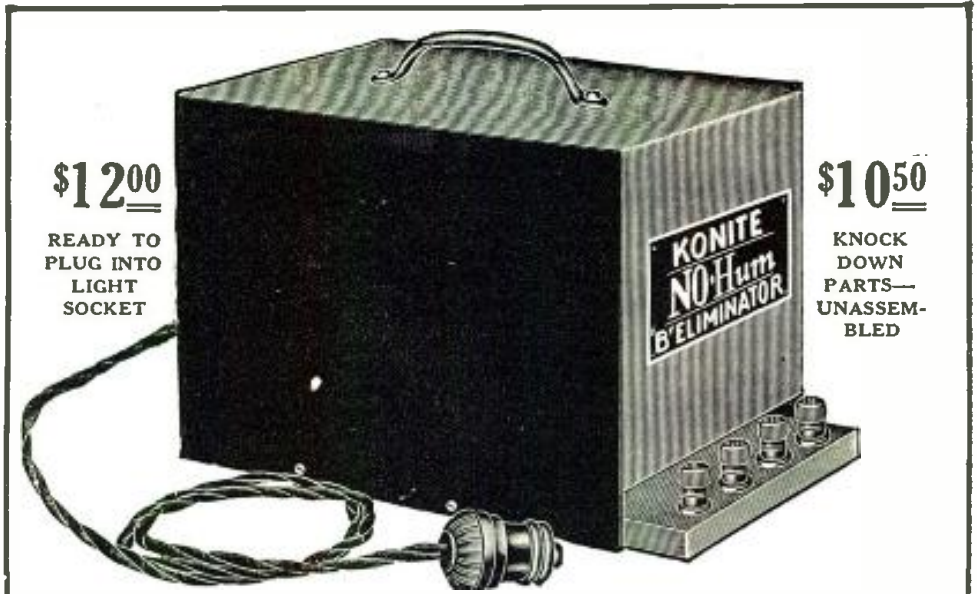

You Don't Know the Convenience of perpetual B battery supply until you have tried the Konite "No-Hum" B Eliminator

How many times have your guests come to the house and you offered apologies for poor reception because your B batteries were "down and out?"
 You can always depend upon the electric light company to furnish electricity and by just plugging into the light socket, you will always have a B battery supply for your radio set by using the KONITE "NO-HUM" B ELIMINATOR.

The voltage will never vary. If you use 2 1/2 or 45 volts for your detector and 90 volts on your amplifier, the KONITE "NO-HUM" B ELIMINATOR will always deliver the specified amount of voltage. To get good volume from your set, you must supply the full amount of voltage required.

The KONITE "NO-HUM" B ELIMINATOR always delivers capacity voltage.

4 Taps B —; 2 1/2 V.; 45 V.; 90 Volts.
 There is no trace of a hum on loud speaker reception with the KONITE "NO-HUM" B ELIMINATOR.

"NO-HUM" gives full wave rectification.
 There is nothing to get out of order and nothing to be replaced.
 Some mechanical devices need oil to keep the machinery working smoothly, but the KONITE "NO-HUM" B ELIMINATOR needs just plain DISTILLED water about every 6 months. IT USES NO ACIDS WHATSOEVER.

The operating expense of current used is less than \$1.00 per year dependent upon the rate of your local light company.

The KONITE "NO-HUM" B ELIMINATOR costs no more than a set of good B batteries—but oh my! how it lasts.

WORKS ON 110 VOLTS A.C., 60 OR 25 CYCLES OPERATES ALL SETS FROM 1 TO 9 TUBES

KONITE CORPORATION, 25-27 West Broadway, New York

DEALERS

We have an excellent proposition for those who desire to handle our line. Write or wire for territory.

The Konite Corporation, 25-27 W. Broadway, New York City

Gentlemen: Please send to me at once: 1 No. 100 Konite "No-Hum" "B" Eliminator, as advertised, all parts, but unassembled \$10.50 □; 1 No. 101 Konite "No-Hum" "B" Eliminator, assembled complete, ready to work \$12.00 □; Payment enclosed □; Send C. O. D. □

Name
 Address
 City..... State.....

A Laboratory Product
CRESCENT LAMITE RESISTANCES
 Used in 50 big broadcasting stations 12,000, 48,000, 50,000 and 100,000 ohms. For distortionless amplification. Order a Crescent today at \$1.50. Special sizes made to order. Discount to dealers.
 Crescent Radio Supply Co., 1-5 Liberty St., Jamaica, N. Y.

MARVELOUS NEW AUDIO TRANSFORMER adds a musical quality to any set far beyond anything you ever heard before. **KARAS HARMONIK** Amplifies low, middle and high tones—all to the same big volume, thus eliminating distortion. Brings out the vital harmonics and overtones of music. Price \$7.00. Write Karas Elec. Co., 1020 Ass'n. Bldg. Chicago

For "UV" or UX Type Tubes NEW KLOSNER UNIVERSAL SOCKET

Hexagonal shaped holes for large prongs, spring grip terminal lugs, and ease in mounting make it the socket leader for 1926.

KLOSNER RADIO CORPORATION
 1022 East 178th Street - New York

RADIO—5-tube Set \$22.50 Delivered

Think of it! A big handsome, efficient five tube Radio receiver only \$22.50 delivered. Tremendous range, clear powerful volume and simple tuning. Literature free. Radio Tubes, all types 95c postpaid.

SEMINOLE CO., Dept. Y.,
 427 East 16th St., New York
 Agents and Dealers Write



Insure your copy reaching you each month. Subscribe to Radio News—\$2.50 a year. Experimenter Publishing Co., 53 Park Place, New York City.

OPPORTUNITY AD-LETS

Follow these advertisements every month. Reliable advertisers from all over the country offer their most attractive specials in these columns.

Classified advertising rate twenty-two cents a word for each insertion. Ten per cent discount for 6 issues, 20 per cent discount for 12 issues. Name and address must be included at the above rate. Cash should accompany all classified advertisements unless placed by an accredited advertising agency. No advertisement for less than 10 words accepted.

Objectionable or misleading advertisements not accepted. Advertisements for the November issue must reach us not later than September 1st.

CIRCULATION LARGER THAN THAT OF ANY OTHER RADIO PUBLICATION

EXPERIMENTER PUBLISHING CO., INC., 53 Park Place, New York, N. Y.

Agents Wanted

Big Money and fast sales. Every owner buys gold initials for his auto. You charge \$1.50; make \$1.35. Ten orders daily easy. Write for particulars and free samples. American Monogram Co., Dept. 133, East Orange, N. J.

Guaranteed Genuine Gold Leaf Letters anyone can put on store windows. Large profits, enormous demand. Free samples. Metallic Letter Co., 422 N. Clark, Chicago.

Agents—our super embossed display signs for all stores are tremendous sellers. \$75 to \$100 per week easily made. Write now for details. Artistic Signs, 799-O Broadway, New York.

If I send you shoes in the style you select, the leather you like—high or low as you please, will you keep them, wear them, show them to your friends as sample of my \$15 Custom-Grade shoes to sell at \$7.35? Advise today. I will immediately mail complete outfit, absolutely free. Dept. A359, Forrest Dustin, 932 Wrightwood, Chicago.

Amazing Large Cash Commission introducing beautiful \$3.95 and \$4.95 Fit-To-Measure guaranteed shoes. Actual samples furnished. Write for your territory. Styis Arch Shoe Co., Dept. 131J, Cincinnati, Ohio.

Earn \$45 to \$85 extra a Week. Selling beautiful Shirts. Commission in advance. We deliver and collect. Write quick. Fashion Wear Shirts, Dept. L-1622, Cincinnati.

Business Opportunities

Free Book. Start little Mail Order Business. Pier. 996 Cortland Street, N. Y.

Responsible manufacturer wants competent men to manage office and salesmen. \$300 to \$1500 necessary; will allow expenses to Trenton if you qualify. Address Manager, 536 Forst Bichey Bldg., Trenton, N. J.

Chemistry

Learn Chemistry at Home. Dr. T. O'Connor Sloane, noted educator and scientific authority, will teach you. Our home study correspondence course fits you to take a position as chemist. See our full page ad on page 294 of this issue. Chemical Institute of New York, 66 W. Broadway, New York City.

Correspondence Courses

Used correspondence school courses. All kinds. Sold on repurchase basis. Big savings. Money back guarantee. Lists free. (Courses bought). Lee Mountain, Pisgah, Alabama.

Help Wanted

Detectives Needed Everywhere. Travel. Experience unnecessary. Write: George Wagner, former Government Detective, 1968 Broadway, N. Y.

Earn \$25 weekly, share time, writing for newspapers, magazines. Experience unnecessary. Details FREE. Press Syndicate, 973, St. Louis, Mo.

All men—women, 18-60, wanting to qualify for Permanent Government Positions. \$140-\$300 month, home or elsewhere. Write: Mr. Ozment, 251, St. Louis, Mo.

Men Wanting U. S. mail positions, \$142-\$225 monthly; steady; experience or correspondence course unnecessary; details free. Write R. Bradford, 112 Bergen Ave., Jersey City, N. J.

Incorporations

Delaware Incorporator, Charters; Fees Small; forms. Chas. G. Guyer, 901 Orange St., Wilmington, Del.

Instruction

Learn Chemistry at Home. Dr. T. O'Connor Sloane noted educator and scientific authority, will teach you. Our home study correspondence course fits you to take a position as chemist. See our full page ad on page 294 of this issue. Chemical Institute of New York, 66 W. Broadway, New York

Miscellaneous

I Catch from 45 to 60 Foxes in from 4 to 5 weeks' time, can teach any reader of this magazine how to get them. Just drop me a card for particulars. W. A. Hadley, Stanstead, Quebec, Canada.

Inventors: Use our special service for presenting your invention or patent to manufacturers. Adam Fisher Mfg. Co., 278-A Enright, St. Louis, Mo.

Secret of Longer Tire Mileage now revealed by Akron Tire Engineers. Complete instructions sent for 25c (in coin). Tire Development Engineers, Box 458, Akron, Ohio.

Motorcycles, Bicycles

Don't Buy a Bicycle Motor Attachment until you get our catalog and prices. Shaw Mfg. Co., Dept. 6, Galesburg, Kansas, City.

Old Coins

German Gov't Bond 5,000,000 Mk. 1924, \$1.50. 2,000,000 Mk Bond 1923, \$5.00. 500,000 Mk. Bill and Catalogue, 10c. Norman Shultz, Colorado Springs, Colo.

Patent Attorneys

Inventors—Should write for our Free Guide Books and "Record of Invention Blank" before disclosing inventions. Send model or sketch of your invention for our Free Inspection and Instructions. Radio, Electrical, Chemical, Mechanical and Trademark experts. Terms reasonable. Victor J. Evans & Co., 923 Ninth, Washington, D. C.

Patents. Send drawing or model for examination and report as to patentability. Advice and booklet free. Highest references. Best results. Promptness assured. Watson E. Coleman, Patent Lawyer, 644 G Street, N. W., Washington, D. C.

Inventors—who derive largest profits know and heed certain simple but vital facts before applying for patents. Our book Patent-Sense gives those facts; free. Write Lacey & Lacey, 631 F St., Washington, D. C. Established 1869.

Patents—Send for form "Evidence of Conception" to be signed and witnessed. Form, fee schedule, information free. Lancaster and Allwine, Registered Patent Attorneys in United States and Canada, 269 Ouray Bldg., Washington, D. C.

Patents

Inventions Commercialized. Patented or unpatented. Write Adam Fisher Mfg. Co., 278 Enright, St. Louis, Mo.

Patents For Sale

Mr. Inventor, if you have a patent or invention for sale. Write Hartley, 38 Court St., Bangor, Me.

Postage Stamps

Stamp Collectors—Phillips Monthly Bulletin (illustrated) offers over 2000 special bargains, sets, packets, single stamps etc., each issue. Free. Phillips, Box 1012, Hartford, Conn.

Printing Outfits and Supplies

Print your own cards, stationery, circulars, paper, etc. Complete outfit, \$2.85; Job Presses \$12, \$35; Rotary \$150. Print for others, big profit. All easy, rules sent. Write for catalog presses, type, paper, etc. Press Company, A-13, Meriden, Conn.

Radio

Amateurs Handbook, contains best radio articles from "Radio News". 128 pages, size 9x12 inches, valuable, instructive. Price 50c. Sold everywhere. Experimenter Pub. Co., Inc., 53 Park Place, N. Y.

500 Radio Wrinkles. Just off the Press. Hints, helps for every Radio User. 100 pages, illustrated, size 9x12 inches. Price 50c. Sold everywhere. Experimenter Pub. Co., Inc., 53 Park Place, N. Y.

Build a Lifetime "B" battery from my better Edison Elements. With welded connections 7c pair. Sample cell 10c. Paul Mills, Woodburn, Oregon.

Boys! Don't Overlook This. The "Rasco" Baby Detector. Greatest detector ever brought out with molded base. Fully adjustable. See former advertisements in this publication, or our catalog. Detector with Galena Crystal, complete 50c, the same detector with Radiocite Crystal, 75c prepaid. Send for yours today. Radio Specialty Company, 96-98 Park Place, New York City.

Attention!—50 Vacuum tube hook-ups. The greatest collection of vacuum tube circuits ever brought under two covers at such insignificant cost. These diagrams will be found in the great "Rasco" catalog, which contains raw materials and parts in a greater profusion than any other catalog. 15c in stamps, or coin, will bring the catalog to you. Radio Specialty Co., 96-98 Park Place, New York City.

World's Finest Loud Speaker. A three-foot cone speaker. Unit developed by the inventor of the Tropadyne. Can be assembled in fifteen minutes, saving 80% of the cost. Complete Kone Kit with blue prints sold on rigid money back guarantee, shipped prepaid, \$10. Engineers' Service Company, 25 Church Street, New York.

Transmitting Sets & Parts, Wavemeters, etc. S. Strobel Co., 3923 N. 6th St., Philadelphia, Pa.

Run Your Radio Direct from the Light Circuit with New Improved Majestic "A-B" eliminator \$65; Majestic "B" small \$32.50, large \$39.50. Kits—Silver-Cockaday 4-tube single control \$39.25, LC-29 \$62, Silver Six \$53, Hammarlund-Roberts \$60, Victorcen super \$75. All latest products of Bremer-Tully, Silver-Marshall, Thordarson, All-American. Send for prices or information on anything you want. Vernon Sell, Knoxville, Iowa.

\$200 For a 50H choke for that "B" Eliminator or speaker circuit. Audio Transformers 70c up. Write for list. Radio Parts Sales Co., Box 24, Orange, N. J.

Therola Doughnut Coils. \$4.75 per set of three. Remler G31 Condensers. \$3.75. Lacults' Ultradyne Superheterodyne Kits, \$12.82. Postpaid. New and Second Hand Sets at bargain prices. Send for list. Acme Trading Co., Box 281, St. Louis, Mo.

Play your Phonograph thru your Radio. Results equal to New Electric Phonographs. Inexpensive hook-up. Complete Plans \$1.00. Mogle & McClelland, Dept. B, Winfield, Kansas.

Liberal Discount on complete line of standard radio parts, sets, and electrical appliances. Satisfaction or money returned. Price list for stamp. Midwest Radio Supply, Box 222, Racine, Wisconsin.

Audio Frequency Transformers rewound and repaired ONE DOLLAR. When burned out send to me. A. L. Krauth, 213 Cherry St., Quincy, Ill.

Ivory Radio Panel beats them all. Write for FREE sample. Ivorylite Radio Panel Co., 3222 Ave. F, Fort Worth, Texas.

BIG SUMMER OFFER

\$2 VALUE \$1 ..FOR..

This is the biggest opportunity of the year.

To the readers of RADIO NEWS we have arranged to offer a big reduction in the famous Conrad Pattern's and E. I. Co. Books; millions of these have been bought by Radio Fans. They are recognized and sold by the best Radio stores and Newsdealers.

We offer any \$2.00 worth of these books and patterns you may select for \$1.

Think of it \$2 for \$1. Just check \$2 worth from the list below and send \$1 with the coupon and we will mail you the materials at once.

LARGE ORDERS ACCEPTABLE IN THE SAME PROPORTION.

MAIL THIS COUPON NOW!

THE CONRAD CO., Inc.,
64 Church St., New York, N. Y.
Gentlemen:—I enclose \$1, please send me the items checked below. (Items checked not to exceed \$2 worth.)

- E. I. BOOKS, regular price 25c**
- No. 1. Tips for the Radio-Constructor.
 - No. 2. How to Make Practical Radio Receivers.
 - No. 3. Radio Questions Answered.
 - No. 5. Loud Talkers and How to Build Them.
 - No. 6. How to Tune Your Radio Set.
 - No. 7. One Hundred Radio Hook-ups.
 - No. 8. All About Radio Parts.
 - No. 9. History and Operation of Vacuum Tubes.
 - No. 10. The Neutrodyne and All About It.
 - No. 11. How Radio is Received.
 - No. 13. Reflex Radio Receivers.
 - No. 14. The Super-Heterodyne, Theory and Construction.

- CONRAD PATTERNS, regular price 50c**
- No. 2. How to Make a Two-Stage Amplifier.
 - No. 4. How to Make a Reinartz Receiver.
 - No. 5. How to Make a Reflex Receiver.
 - No. 6. How to Make a Cockaday Receiver.
 - No. 9. How to make the S. T. 100 Receiver.
 - No. 11. How to Make a Five-Tube Cockaday Receiver.
 - No. 12. How to Make a Portable Receiver.
 - No. 13. How to Make a Harkness Receiver.
 - No. 15. How to Make a Low Loss Receiver.
 - No. 16. How to Make the Tropadyne Super-radio.
 - A. Radio Map of the U. S. on Cloth.
 - B. 20 Radio Diagrams and Hook-ups.
 - C. All About Aerials and Their Construction.
 - D. Radio Amateurs' Practical Design Data.

NAME

ADDRESS

CITY, STATE

Radio—Continued

Hoff's Radio Trouble Finder. Builders' guide, log and dictionary. Particulars free. Stewart, 315 North 49th, Birmingham, Alabama.

Salesmen Wanted

A Frying Position Open to representative of character. Take orders, book—industry, direct to wearer. Good income. Permanent. Write now. Tanners Shoe Mfg. Co., 7-168, C St., Boston, Mass.

Scenery for Rent

World's Most Beautiful Settings for operas, plays, minstrels. Amelia Grain, Philadelphia.

School of Electricity

Electricity—Short day or evening courses in Electricity, Drafting, Engineering, and Architecture. In Chicago earn while you learn. Part Time positions pay expenses. Faculty of experts. Special short courses. Diplomas in 2 years. B.S. Degree in 3 years. Small classes. Individual instruction. 23 year old institution with thousands of successful graduates. Enter any time. Employment bureau. Moderate tuition—monthly payments. New College building—all activities. All details in 72 page "Blue Book." A copy will be sent to you free. Write today. Chicago Technical College, Dept. 27, 118 E. 26th St., Chicago, Ill.

Song Writers

Songwriters: Let me furnish the music for your songs. Guaranteeing you absolute satisfaction. Copyrights secured. Submit your scripts for estimate and free advice. Walter W. Newcomer, 1674 Broadway, New York.

Stammering

Stop Stammering. All speech defects successfully corrected. Samuel Robins, 399 Boylston St., Boston.

St-tut-t-tering and stammering cured at home. Instructive booklet free. Walter McDannell, 121 Arcade, 1126 Granville Avenue, Chicago, Ill.

Stamps and Coins

Newfoundland Stamps on approval. None better—none cheaper. Send want list and references. Rev. Butler, St. Georges, Newfoundland.

Stocks and Bonds

Stocks—Bonds. Domestic—Foreign. bought—sold. Dealers in all marketable securities. Frank Y. Everett & Co., 20 Broad St., New York.

Telegraphy

Telegraphy—Both Morse and Wireless taught thoroughly. Big salaries. Wonderful opportunities. Expenses low. chance to earn part. School established fifty years. Catalog free. Dodge's Institute, Cour St., Valparaiso, Ind.

Wanted to Buy

Full Value Paid for Old Gold, Jewelry, Watches, Diamonds, crowns, bridges, dental gold, silver, platinum, gold or silver ore; magneto points, old raise teeth. Packages returned if our offer is not satisfactory. United States Smelting Works (The Old Reliable) 39 So. State St., Dept. 16, Chicago, Ill.

—FREE—

Send \$1 for 5 months subscription to RADIO NEWS and get one genuine

VALET Auto-Strop Razor FREE!

EXPERIMENTER PUB. CO., Inc.,
53-R Park Place New York, N. Y.

Thousands Use These Ingenious TRANSMITTER UNITS



Here's a marvel of Engineering design—a practical miniature transmitter, used by thousands of radio fans and experimenters for amplification purposes. It is a most novel unit, having hundreds of uses. Every amateur should have two or three of these amplifiers in his laboratory.

A FEW USES FOR THESE UNITS

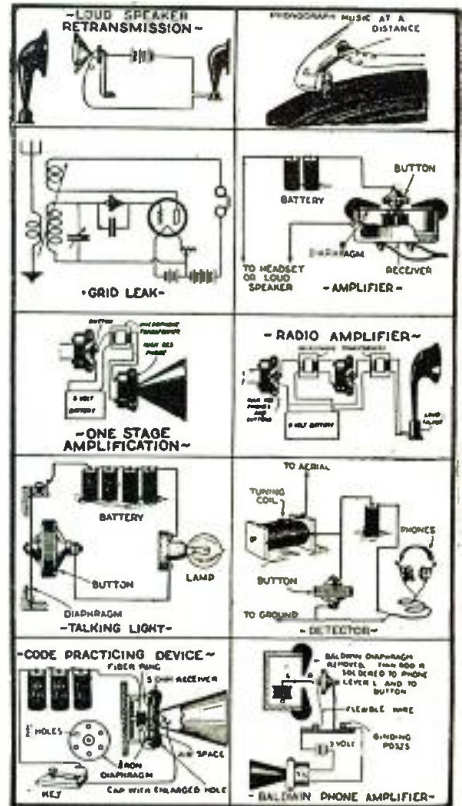

With each unit is mailed an eight-page instruction pamphlet containing suggestions for innumerable uses. Our supply is limited; avoid disappointment by ordering today. The coupon below is for your special convenience.

SPECIALLY PRICED

While they last— **95c**
(or Two for \$1.75) per unit

THE PRESS GUILD,
66-R West Broadway, New York, N. Y.
Enclosed find 95c/\$1.75 for which send me postpaid one/two amplifier units as advertised.

Name

Address

City, State

Van Horne Tubes are manufactured in both the Selected and Certified brands.

The Van Horne Certified tube is wrapped in a glassine wrapper and sealed. A characteristic curve sheet, covering the actual readings of the tube, being enclosed.

They are in a number of types for all receiving purposes, part of them being illustrated below.

**Adapted Mogul 5 VCX,
5 Volt .50 Ampere Audio
Amplifier**

To eliminate any necessity of changing set wiring the Mogul 5 VCX is equipped with a Patented Adapter to which additional voltages are added independently and in addition to the regular set voltages.

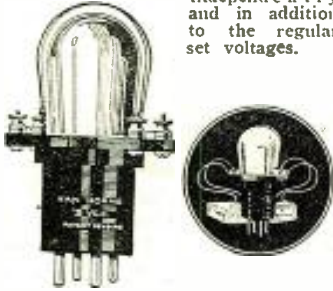

**5 VC, 5 Volt .50 Ampere
Audio Amplifier**

This model is not equipped with the patented Van Horne Adapter found on the model 5 VCX.

It is designed for those receiving sets in which provision has been made in the circuit for the use of the power tube at extra voltages in the last audio stage.



**5 VAX, 5 Volt, 1/4
Ampere Detector Amplifier**



The improved manufacturing process, the use of patented thoriated wire and the precision and care with which this tube is made and tested makes it noticeably superior. Packed in both Selected and Certified Brands.

**3 VBX Dry Cell Detect-
or Amplifier**

An unusually high reading dry cell tube due to the use of patented thoriated tungsten filament. Exceptionally satisfactory where volume with clearness and signal carrying capacity is desired.

NOTE

All Van Horne Tubes are Unconditionally Guaranteed.



The rubber cushion absorbs vibration and eliminates microphonic noises

Cushioned
to stop vibration —
that's why the Cushion
Base Tube makes such
a wonderful improve-
ment in reception

Knowing how much tube vibration impairs the tone quality of reception, fans everywhere are equipping their sets with Cushion Base tubes.*

Equip your set with Cushion Base tubes and note the surprising softness and fullness of tone of reception that follows the elimination of vibration. Order your set from your dealer today.

*These two unusual tubes, the Adapted Mogul 5 VCX Power tube and the Cushion Base tube, offer the greatest possible improvement in reception. They are manufactured exclusively by the Van Horne Company under patents pending to J. S. Van Horne.

For a great many years the Van Horne Company has manufactured vacuum products. The highly skilled workmanship that goes into every Van Horne tube is the result of years of experience and is one of the factors that make Van Horne tubes the highly efficient and dependable tubes that many thousands of users have found them to be. You are urged to become acquainted with the complete line of Van Horne Selected and Certified tubes. Your dealer will supply you with further information—or write for descriptive matter.

THE VAN HORNE COMPANY, Inc.

901 CENTER STREET, FRANKLIN, OHIO